













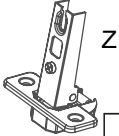

<p>8x30</p>  <p>D</p> <p>20</p>	<p>A</p>  <p>A</p> <p>20</p>	<p>B</p>  <p>B</p> <p>20</p>	<p>X</p>  <p>X</p> <p>20</p>	<p>Z</p>  <p>Z</p> <p>6</p>	<p>L</p>  <p>L</p> <p>6</p>	<p>4x16</p>  <p>H</p> <p>16</p>
<p>I</p>  <p>I</p> <p>14</p>	<p>S</p>  <p>S</p> <p>12</p>	<p>H3</p> <p>3x13</p>  <p>H3</p> <p>4</p>	<p>UD</p>  <p>UD</p> <p>2</p>	<p>H4</p> <p>4.0x30</p>  <p>H4</p> <p>6</p>	<p>ODB</p>  <p>ODB</p> <p>2</p>	



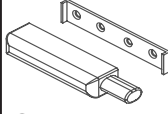
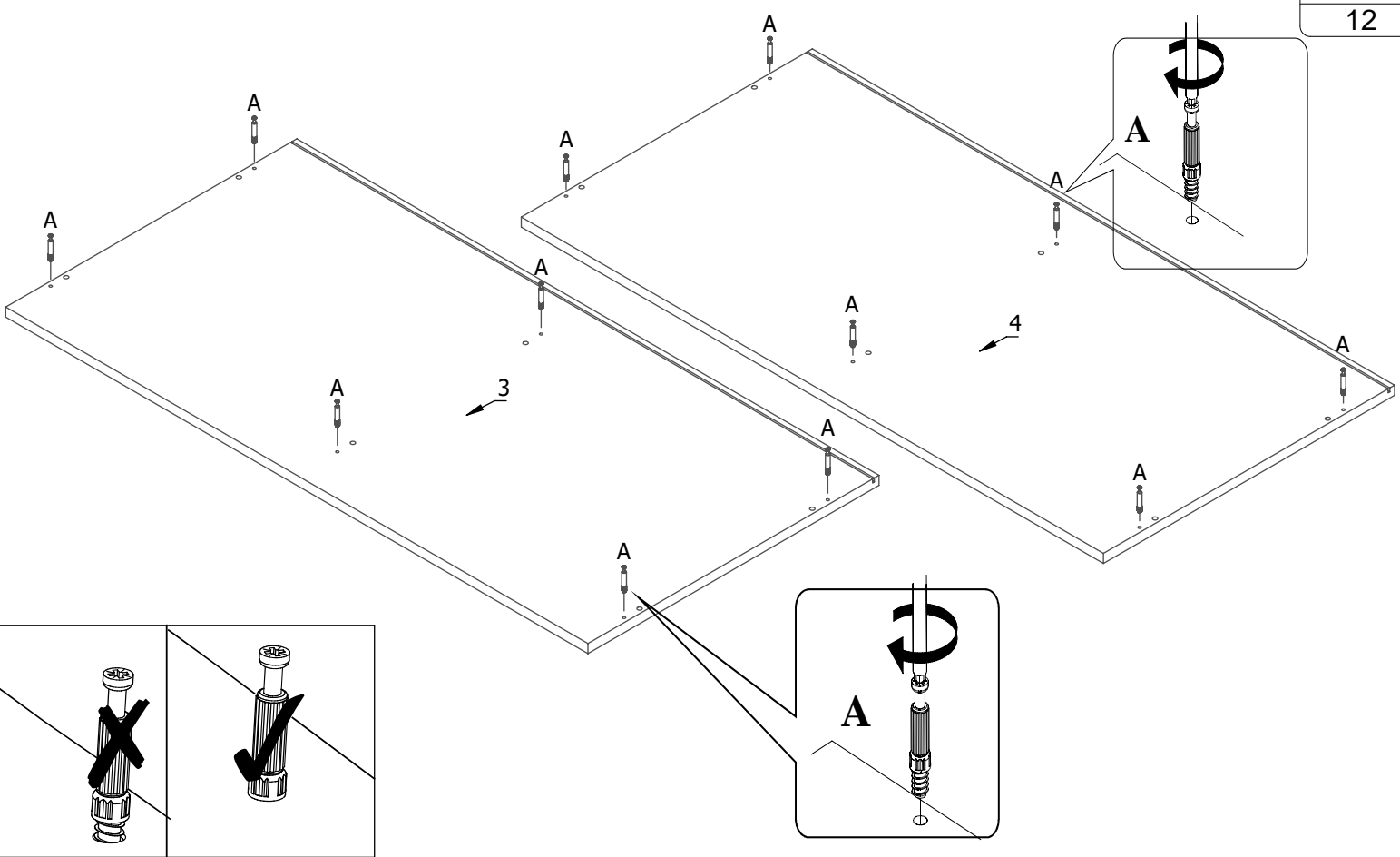
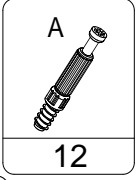
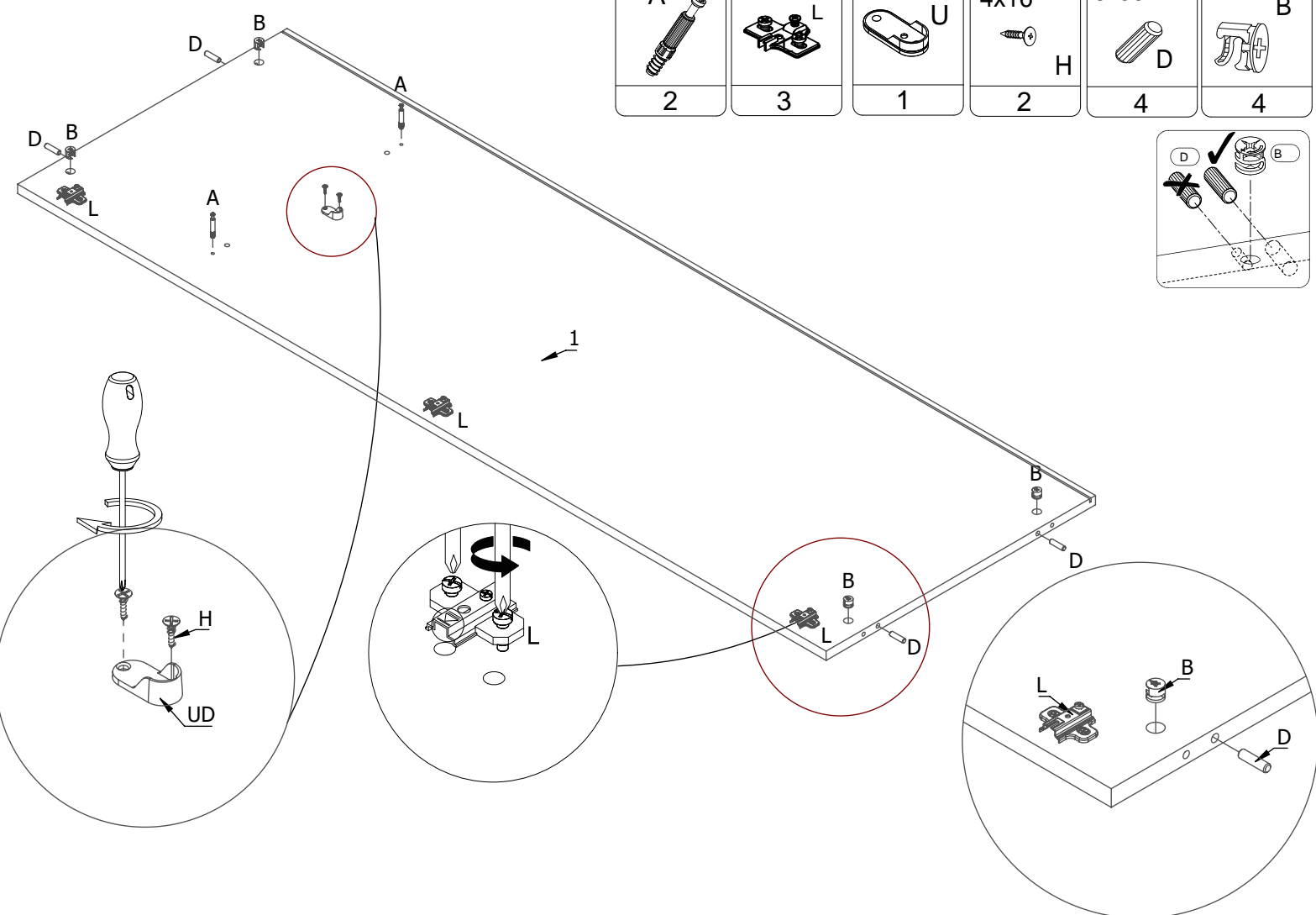
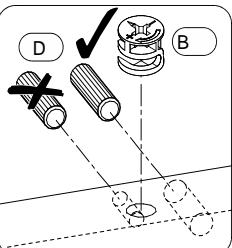

<p>A</p> <p>2</p>	<p>L</p> <p>3</p>	<p>U</p> <p>1</p>	<p>4x16</p> <p>H</p> <p>2</p>	<p>8x30</p> <p>D</p> <p>4</p>	<p>B</p> <p>4</p>
-------------------	-------------------	-------------------	-------------------------------	-------------------------------	-------------------





- A

L

2
- 

3
- S

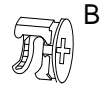
6
- 8x30

D

4
- B

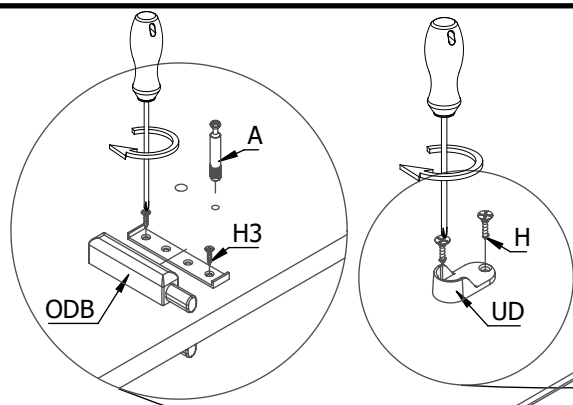
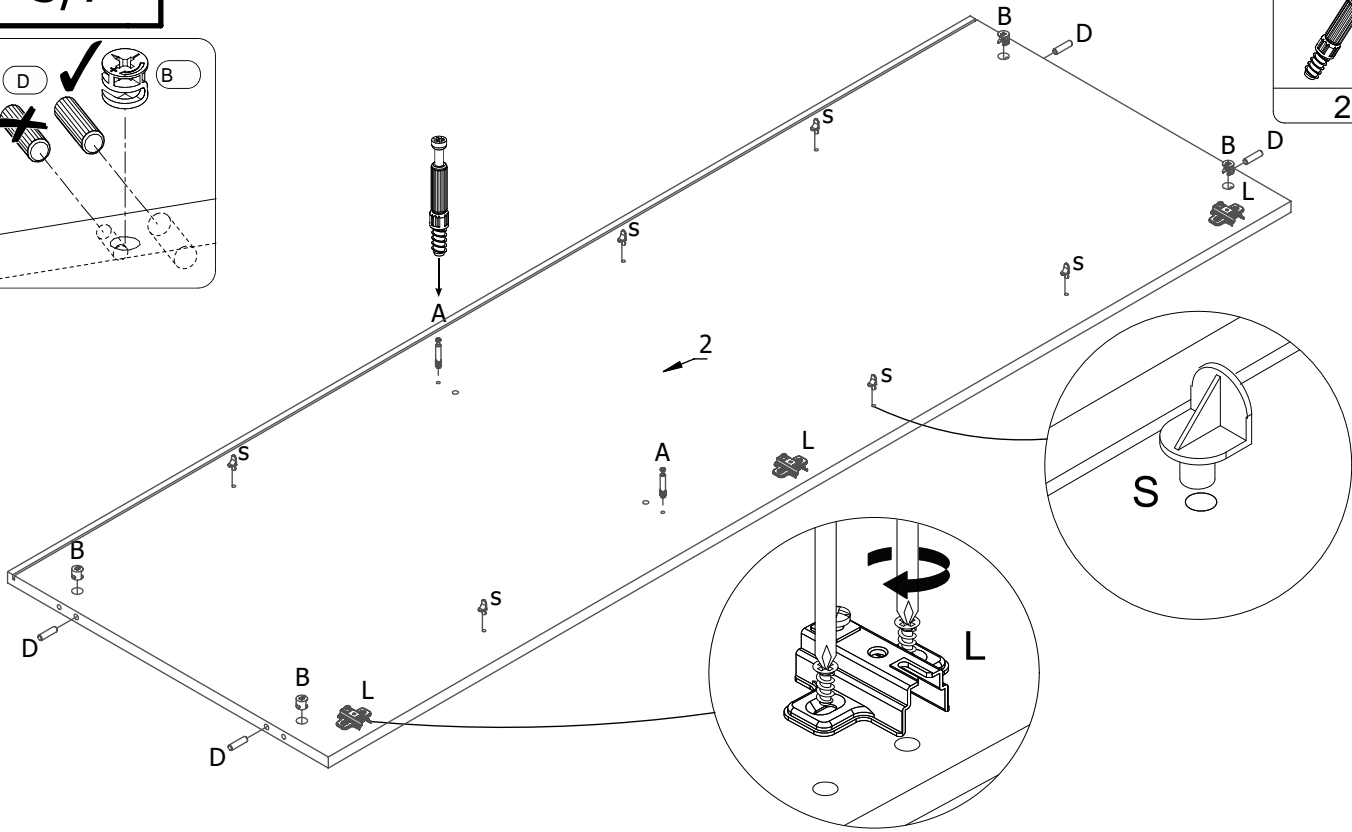
4

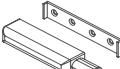

- 3x13

H3

4
- ODB

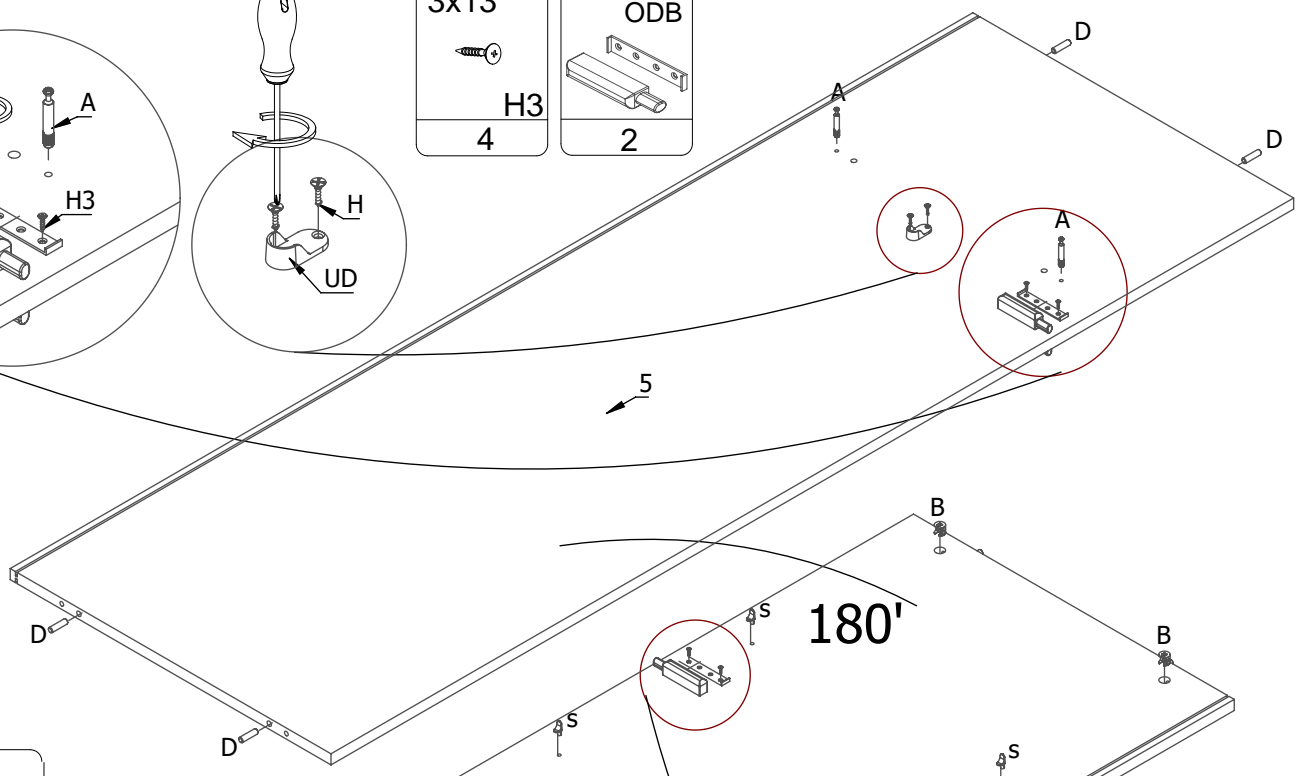
2



- U



1

- A



4

- 4x16

H

2

- 8x30

D

4

- B

4

- S

6

