



MEORATI stolik 80



scan QR code



complete
instruction for
assembling
the furniture

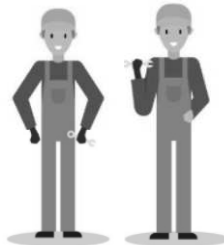
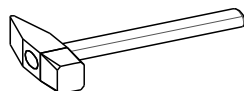

50min

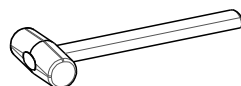
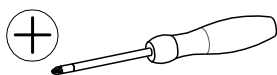

| NR | il | Sz [mm] | Dł [mm] | Gr [mm] |
|----|----|---------|---------|---------|
| 1 | 1 | 800 | 800 | 16 |
| 2 | 1 | 800 | 800 | 16 |
| 3 | 1 | 168 | 759 | 16 |
| 4 | 1 | 168 | 759 | 16 |
| 5 | 1 | 168 | 759 | 16 |
| 6 | 1 | 168 | 375 | 16 |
| 7 | 1 | 100 | 350 | 16 |
| 8 | 1 | 100 | 350 | 16 |
| 9 | 1 | 73 | 318 | 16 |
| 10 | 1 | 353 | 326 | 3 |
| 11 | 1 | 160 | 400 | 40 |

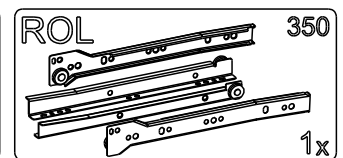
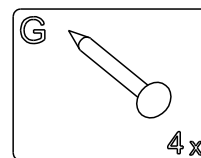
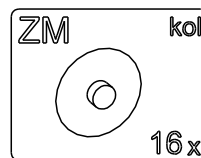
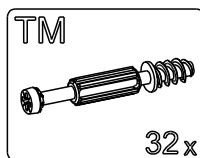
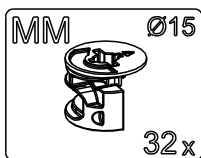
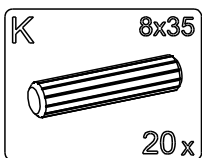
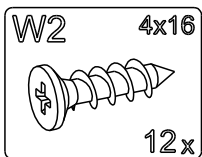
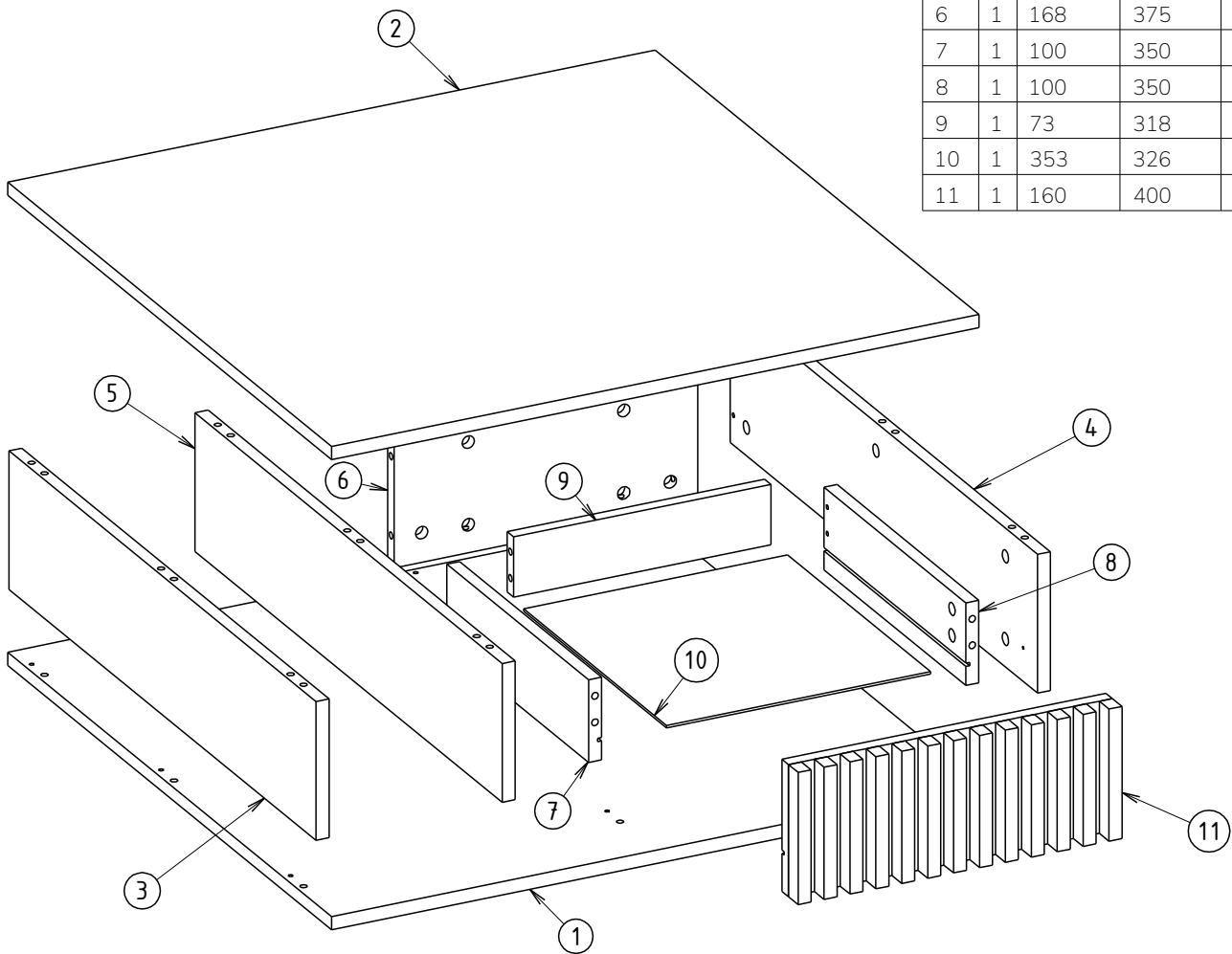

ELTAP Spółka z ograniczoną odpowiedzialnością Sp.k.
 Mroczeń 203, 63-604 Baranów
www.eltap.com

Review Us On **Google**

