

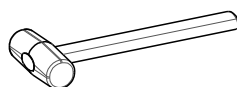

scan QR code

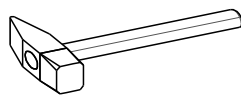

complete
instruction for
assembling
the furniture

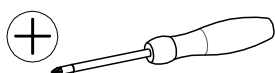
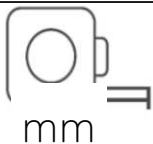
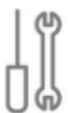
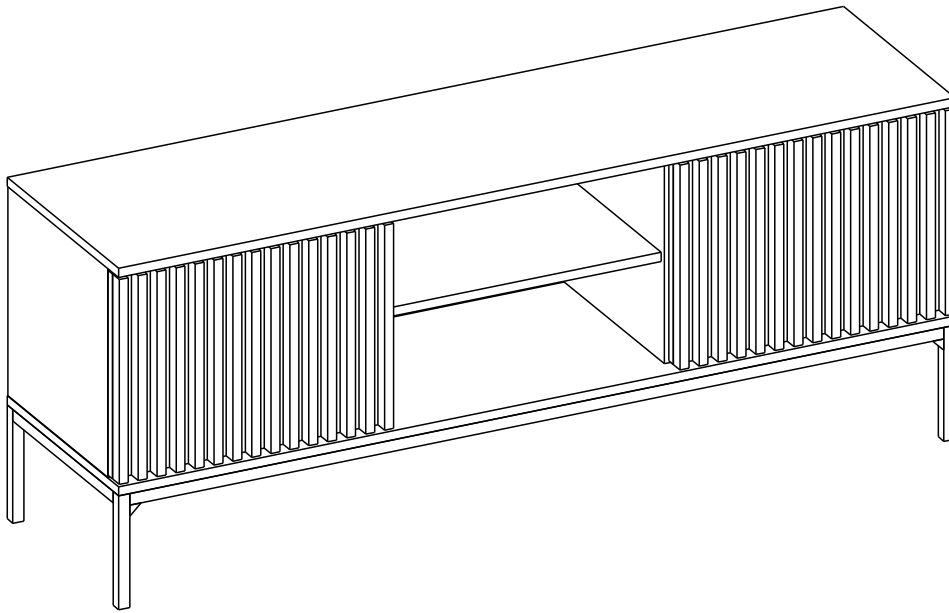

60min

NR	il	Sz [mm]	dł [mm]	gr [mm]
1	1	400	1500	16
2	1	400	1500	16
3	1	359	368	16
4	1	359	368	16
5	1	359	368	16
6	1	359	368	16
7	1	497	349	16
8	2	492	360	40
9	1	394	1494	3

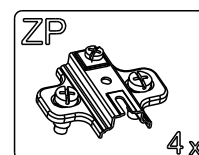
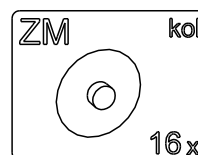
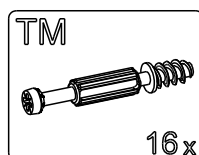
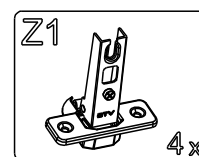
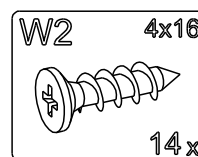
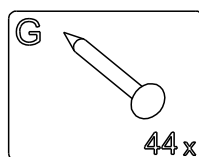
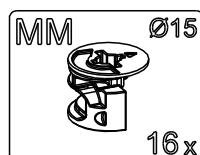
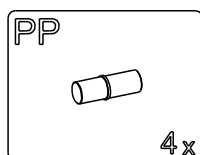
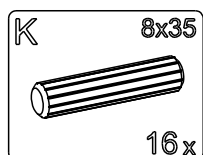
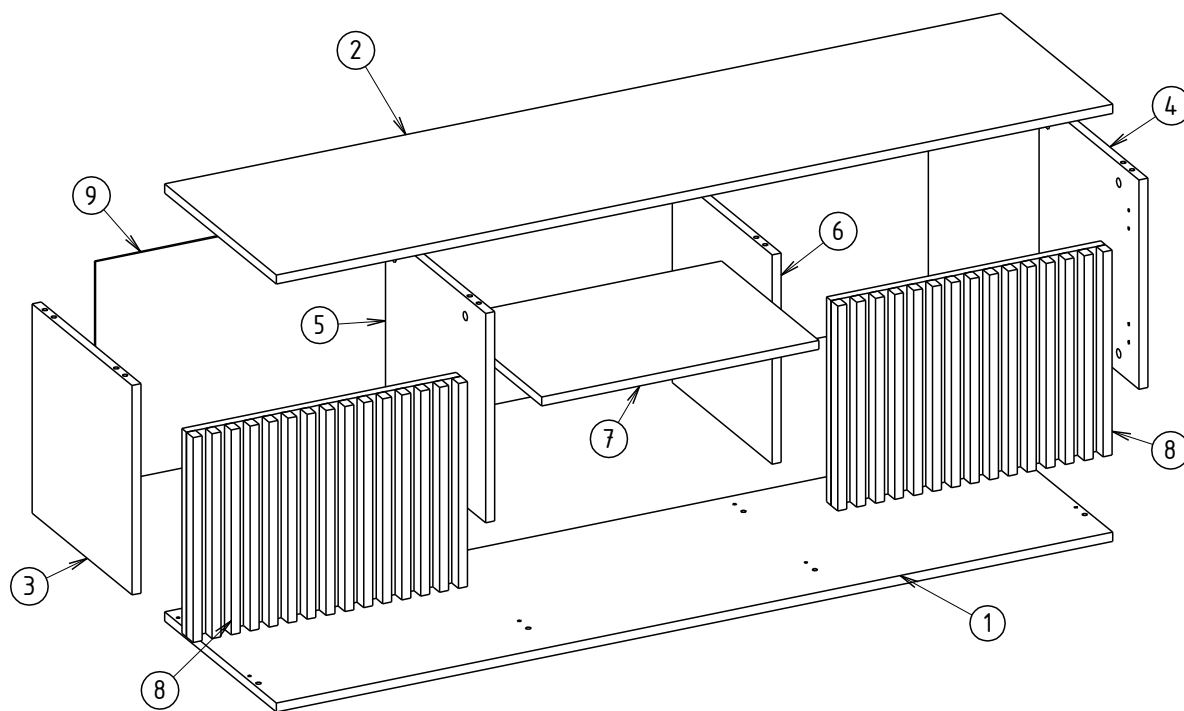

ELTAP Spółka z ograniczoną odpowiedzialnością Sp.k.
 Mroczeń 203, 63-604 Baranów
www.eltap.com

Review Us On **Google**

