

 eltap<sup>®</sup> MEORATI rtv wiszaca



scan QR code



complete  
instruction for  
assembling  
the furniture

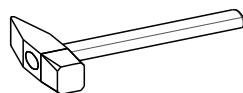
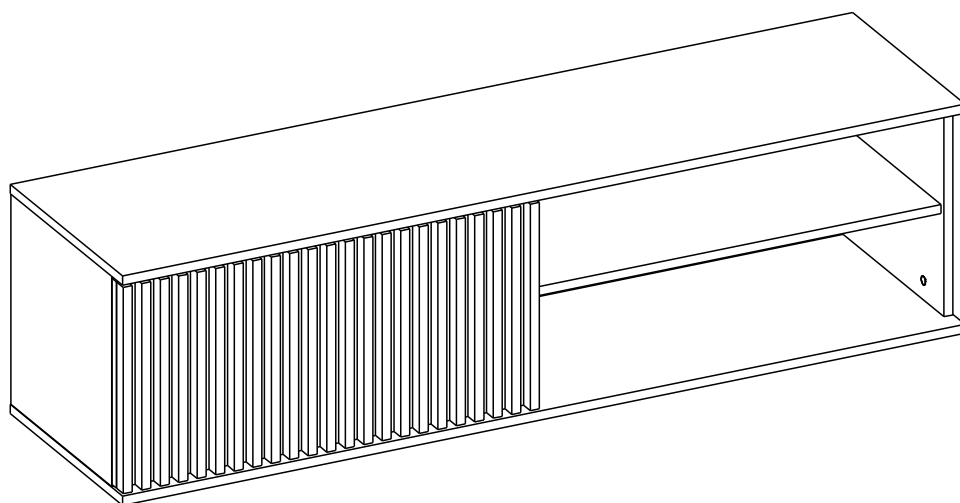

60min

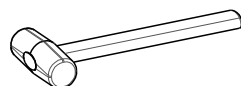
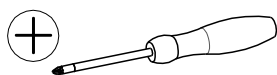

NR	il	Sz [mm]	dl [mm]	gr [mm]
1	1	400	1500	16
2	1	400	1500	16
3	1	359	368	16
4	1	359	368	16
5	1	359	368	16
6	1	725	349	16
7	1	741	360	40
8	1	394	1494	3

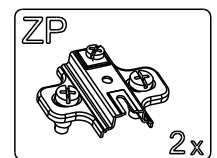
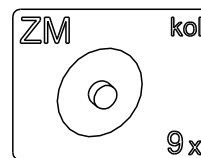
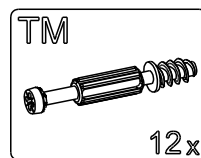
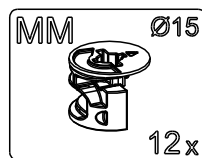
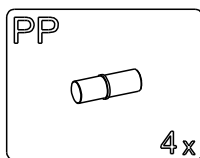
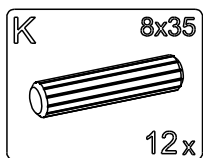
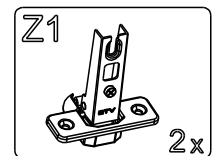
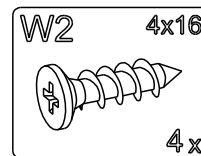
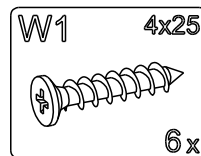
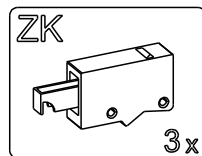
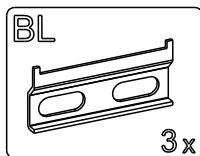
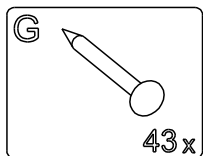
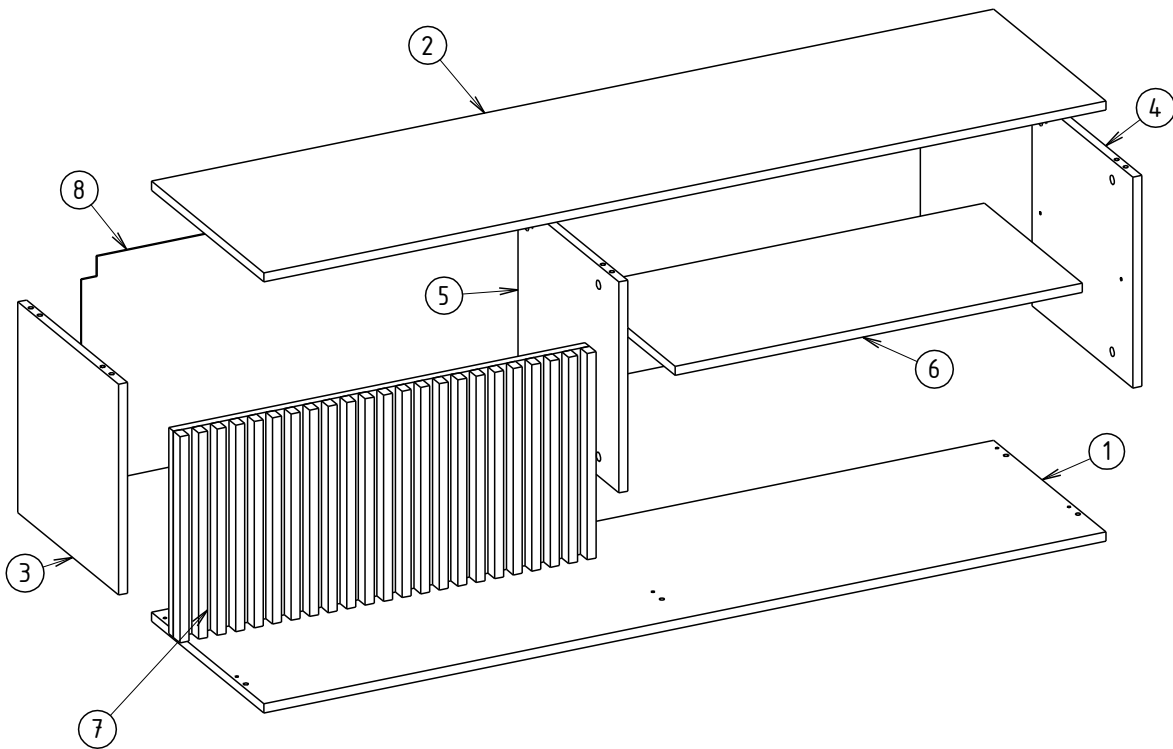

ELTAP Spółka z ograniczoną odpowiedzialnością Sp.k.  
 Mroczeń 203, 63-604 Baranów  
[www.eltap.com](http://www.eltap.com)

Review Us On **Google**

