

BAROLD Biurko 120/140

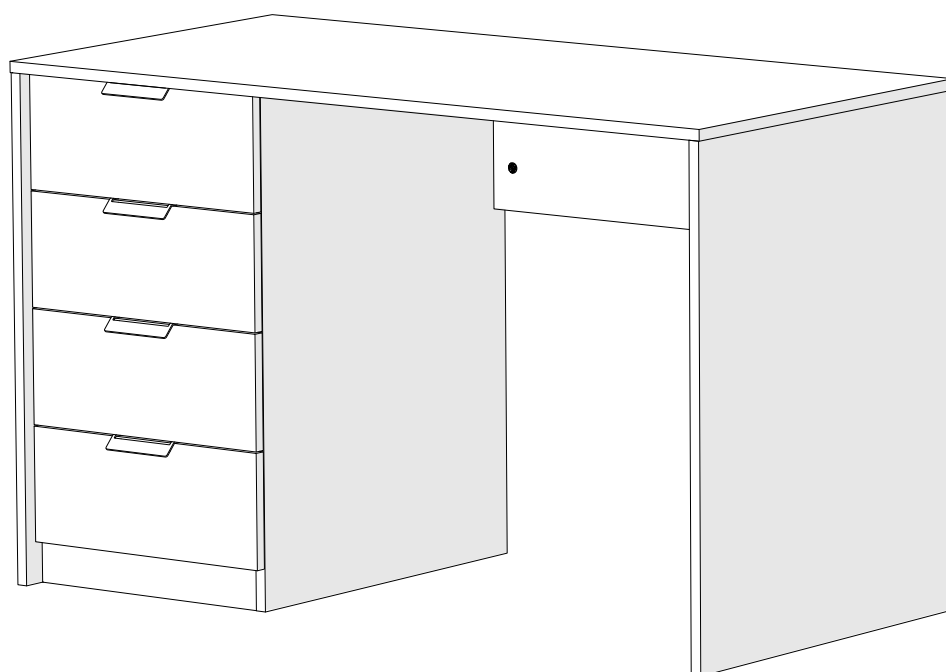

ELTAP Spółka z ograniczoną odpowiedzialnością Sp.k.
Mroczeń 203, 63-604 Baranów
www.eltap.com

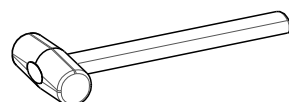

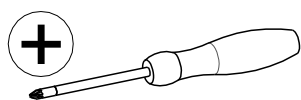
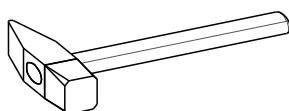
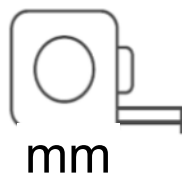
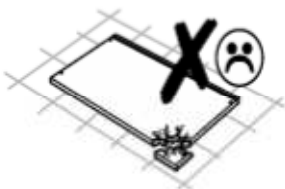
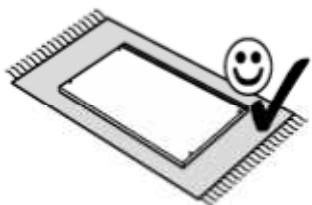

NR	il	Sz [mm]	dl [mm]	gr [mm]
1	1	600	1200/1400	16
2	1	387	538	16
3	1	387	60	16
4	1	599	734	16
5	1	599	734	16
6	1	564	734	16
7	1	230	763/963	16
8	1	387	734	16
9	4	100	500	16
10	4	82	330	16
11	4	100	500	16
12	4	557	345	3
13	4	400	166	16

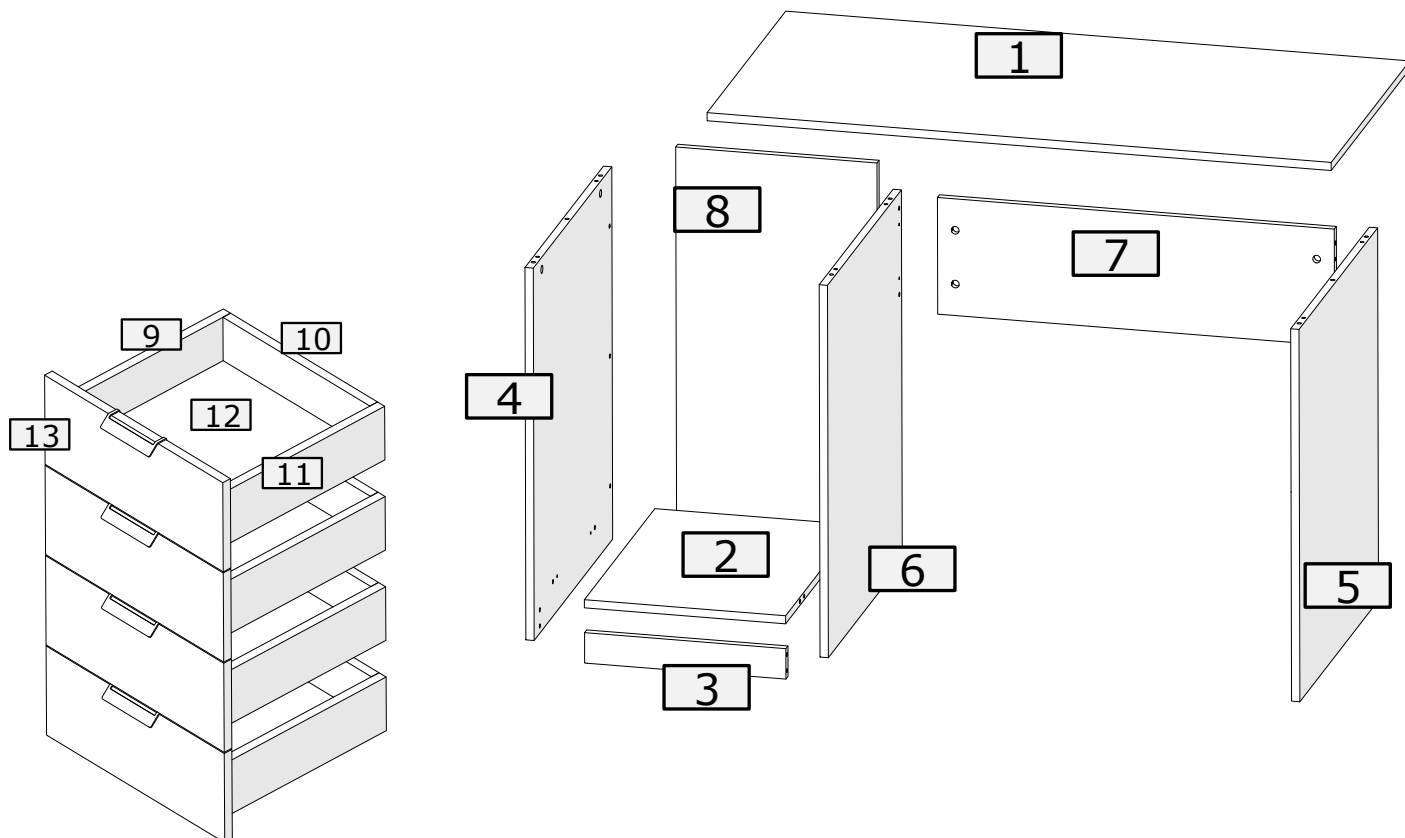

Assembling instruction / Montageanleitung / Notice de montage /
 Montaje de instrucció / Instrukcja montaży / Сборка инструкция /
 Montáž instrukce / Montáž inštrukcie / Szerelési utasítás /
 Сглобяване инструкция / Kurulum Talimatları / Montagem de instrução /
 Sestavljanje navodila / Montage instructie / Склапање инструкцију /
 Asamblarea de instrucțiuni / Sastavljanje upute / Monterings instruktion /
 Istruzioni di montaggio / Збірка інструкція / Montāžas instrukcija /
 Montavimo instrukcija / Paigaldusjuhend / Kokoamisohjeisiin

30	30	42	4	
B	A 8.0x35	D	UB	
X	PK 3.5x16	W2 3.0x16	W3 3.0x20	W1
30	4	32	8	16

1

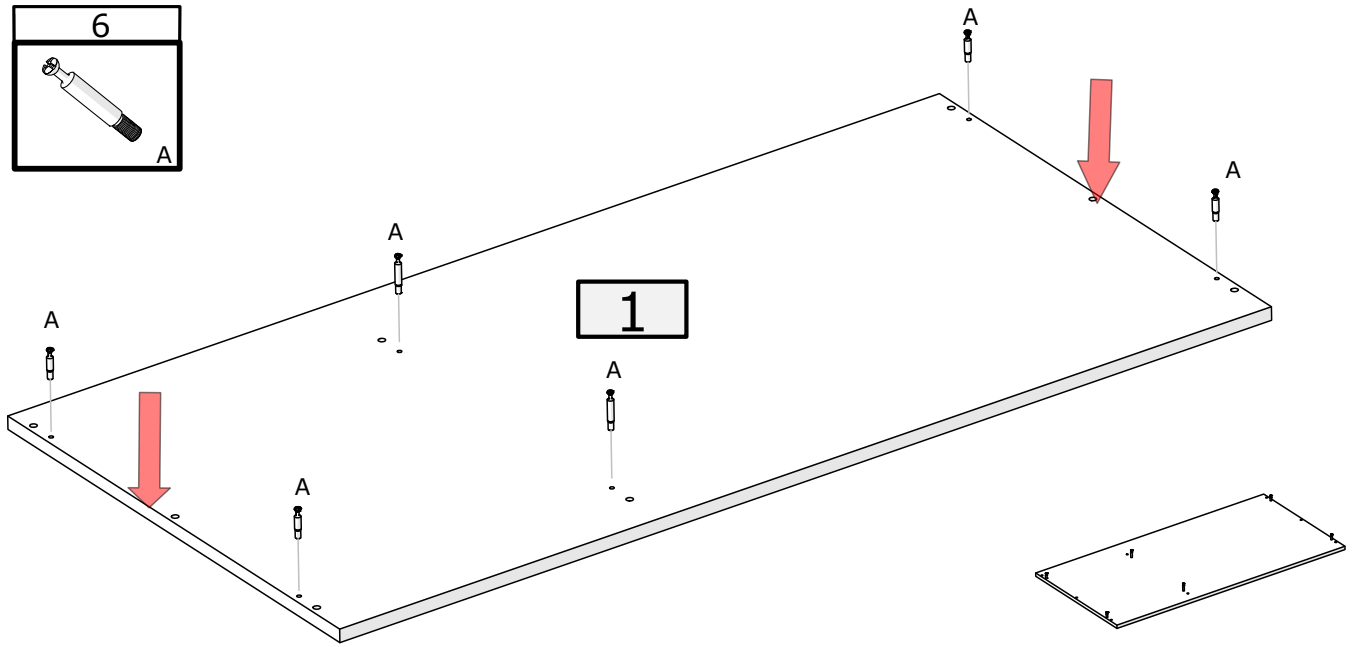
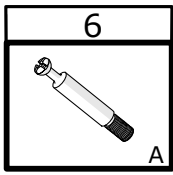

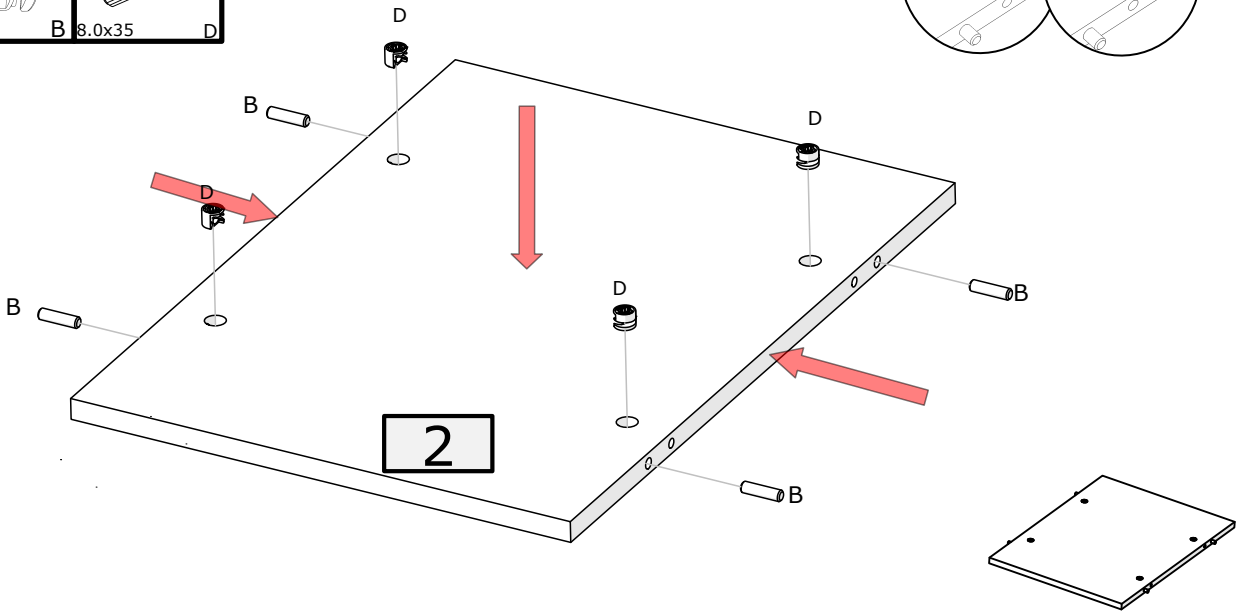
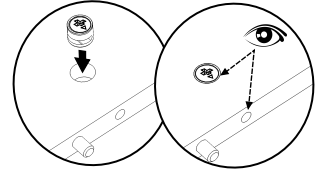
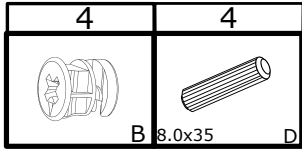

2

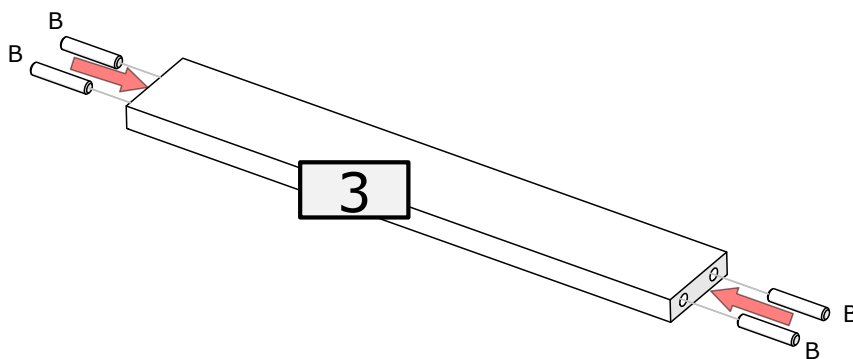
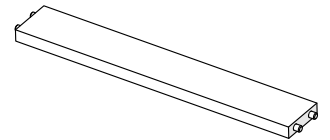
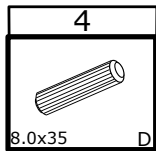

3



4

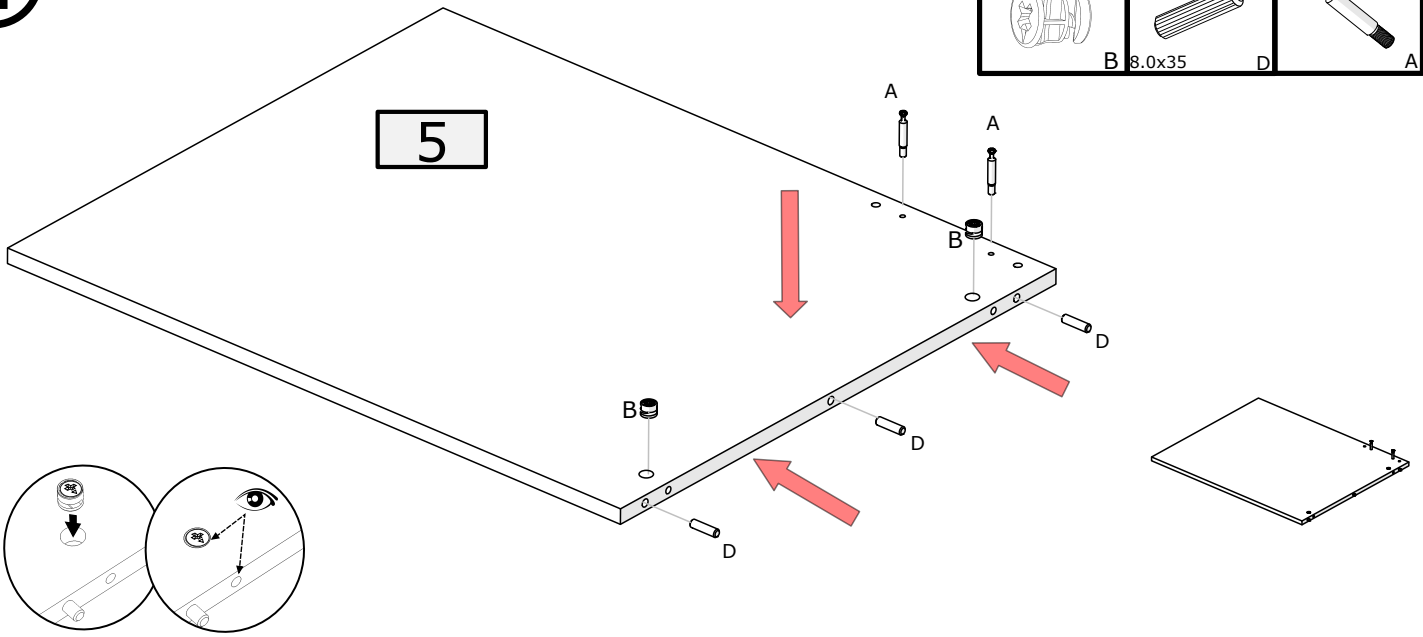

2	3	2
		
B	8.0x35	D



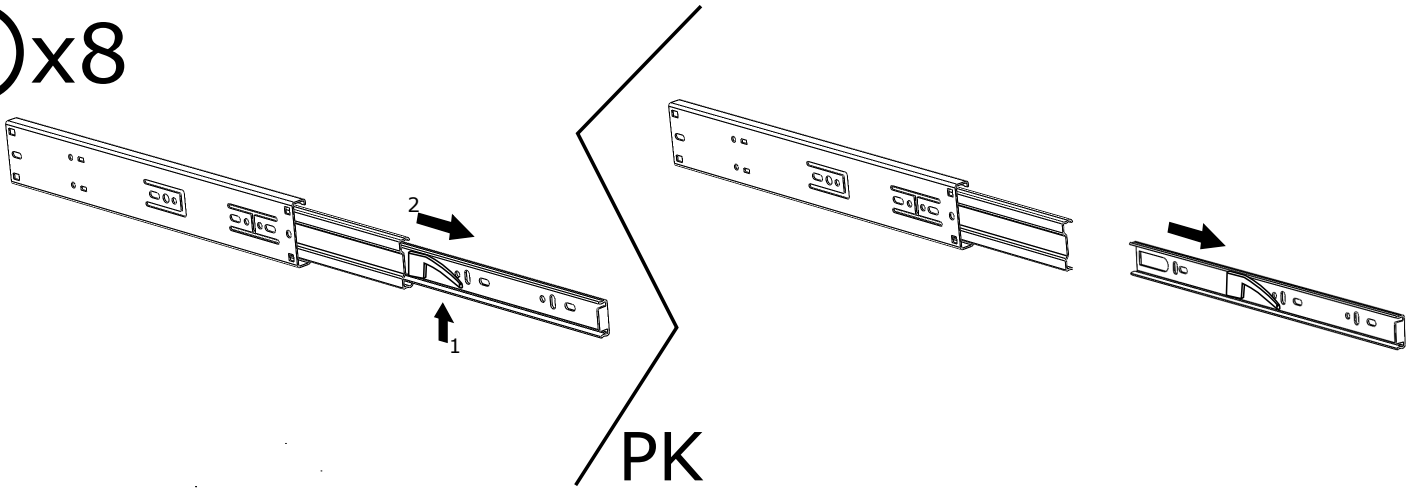

5x8





6

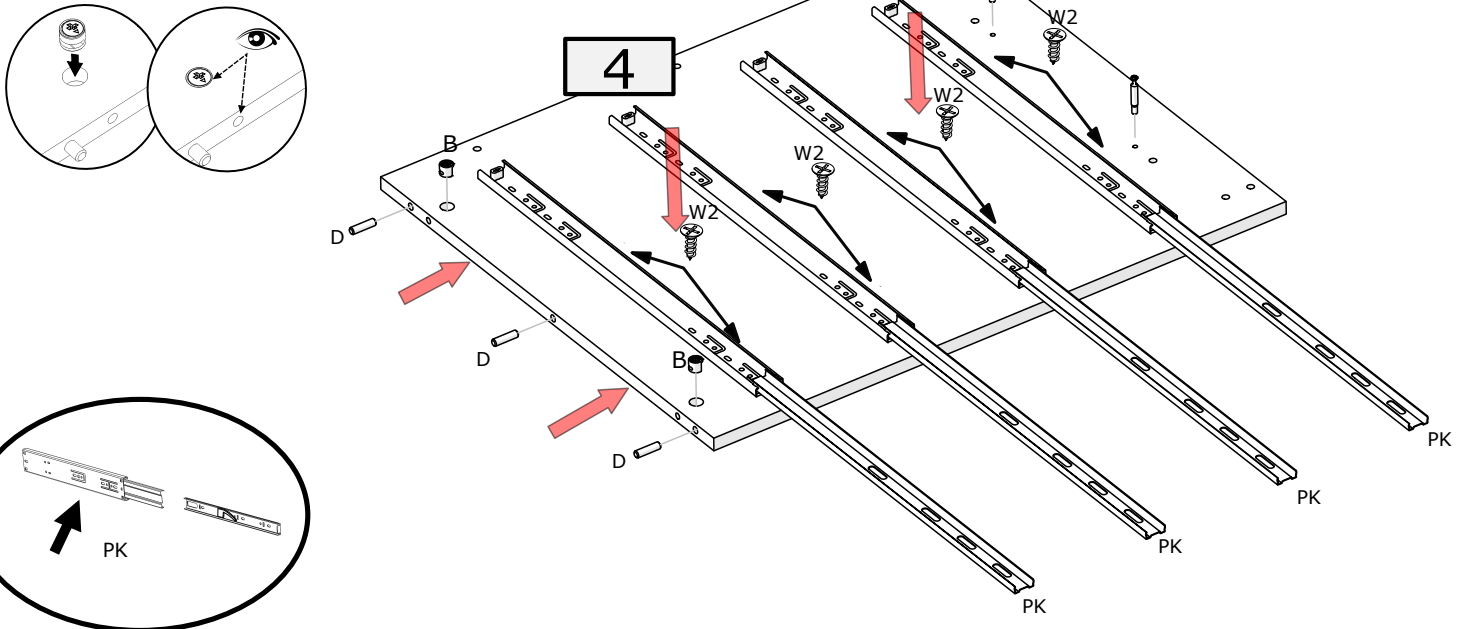

2	3	2
		
B	8.0x35	D

	
PK	3.5x16
4	8



7

2	3	2
		
B	8.0x35	D
A		

	
PK	3.5x16
4	8

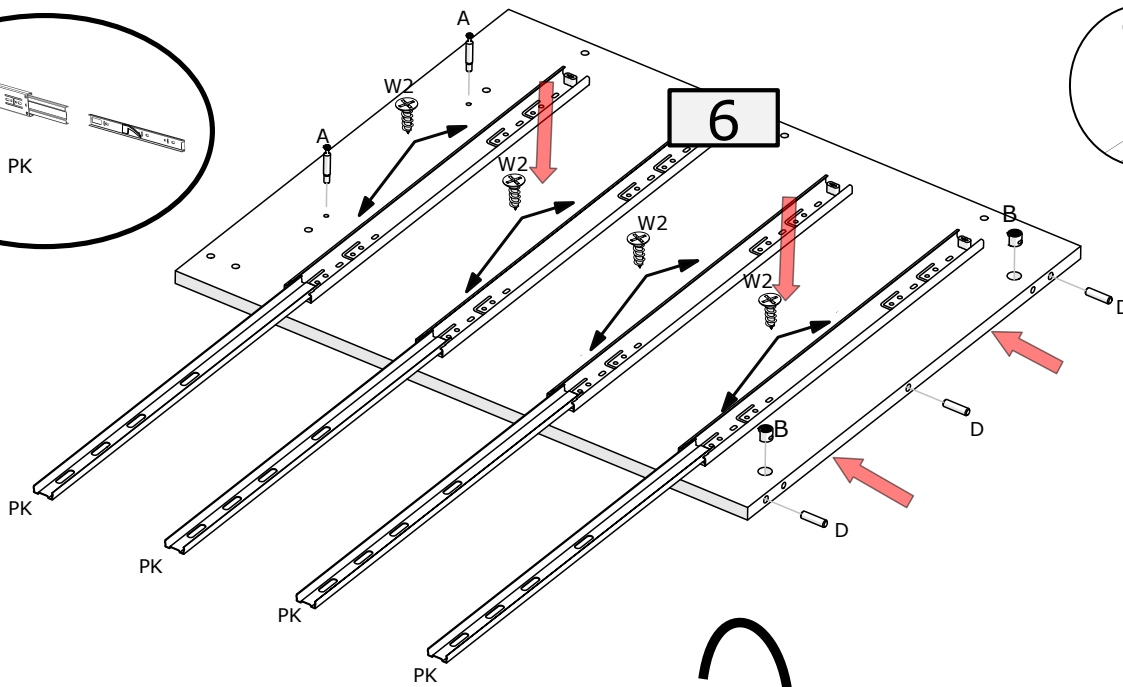
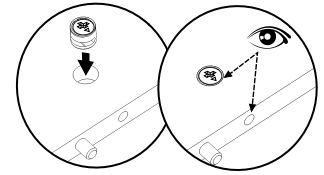
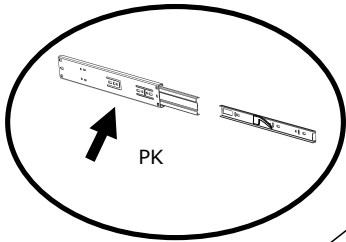

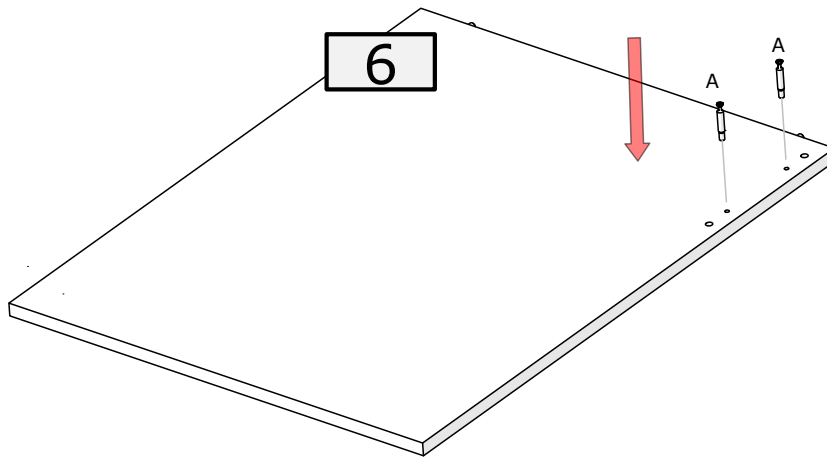

180°

2

A



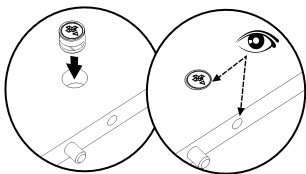
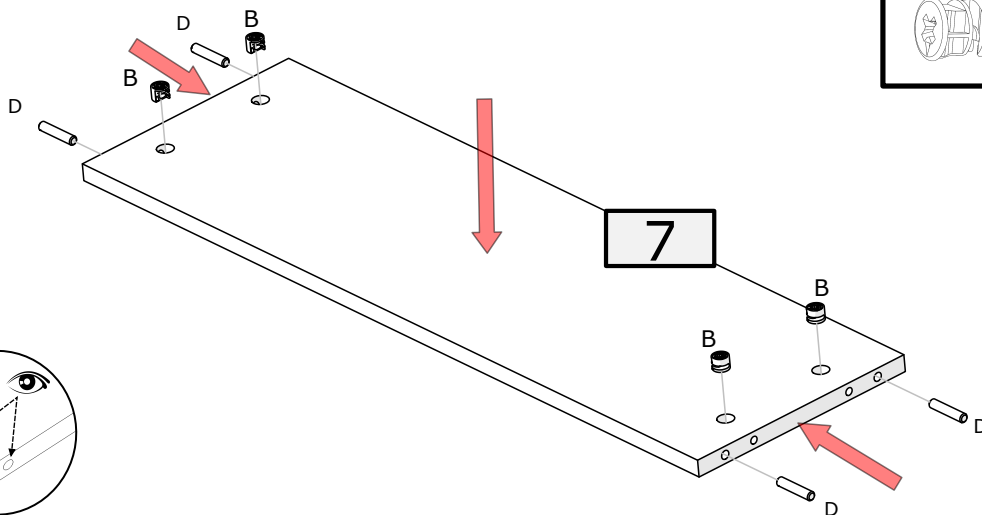

8

4	4
	
B	8.0x35
D	



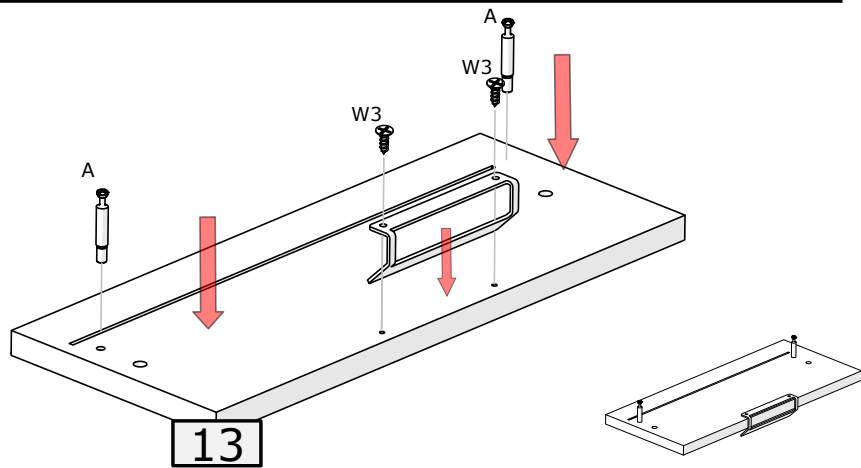

⑨ x4

2	1	2
		
A		3.0x16 W3





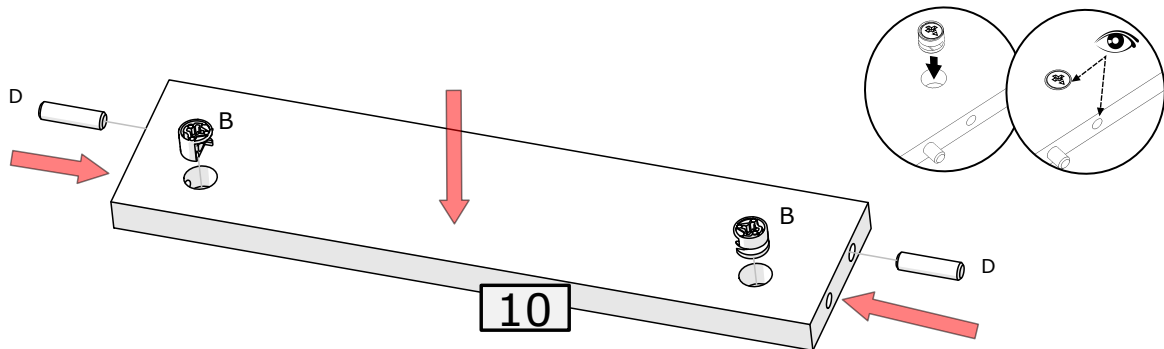

⑩ x4

4	4
	
B	8.0x35 D



⑪ x4

4	2	2	2	2
				
3.5x16 W2	PK	PK	B 8.0x35	D

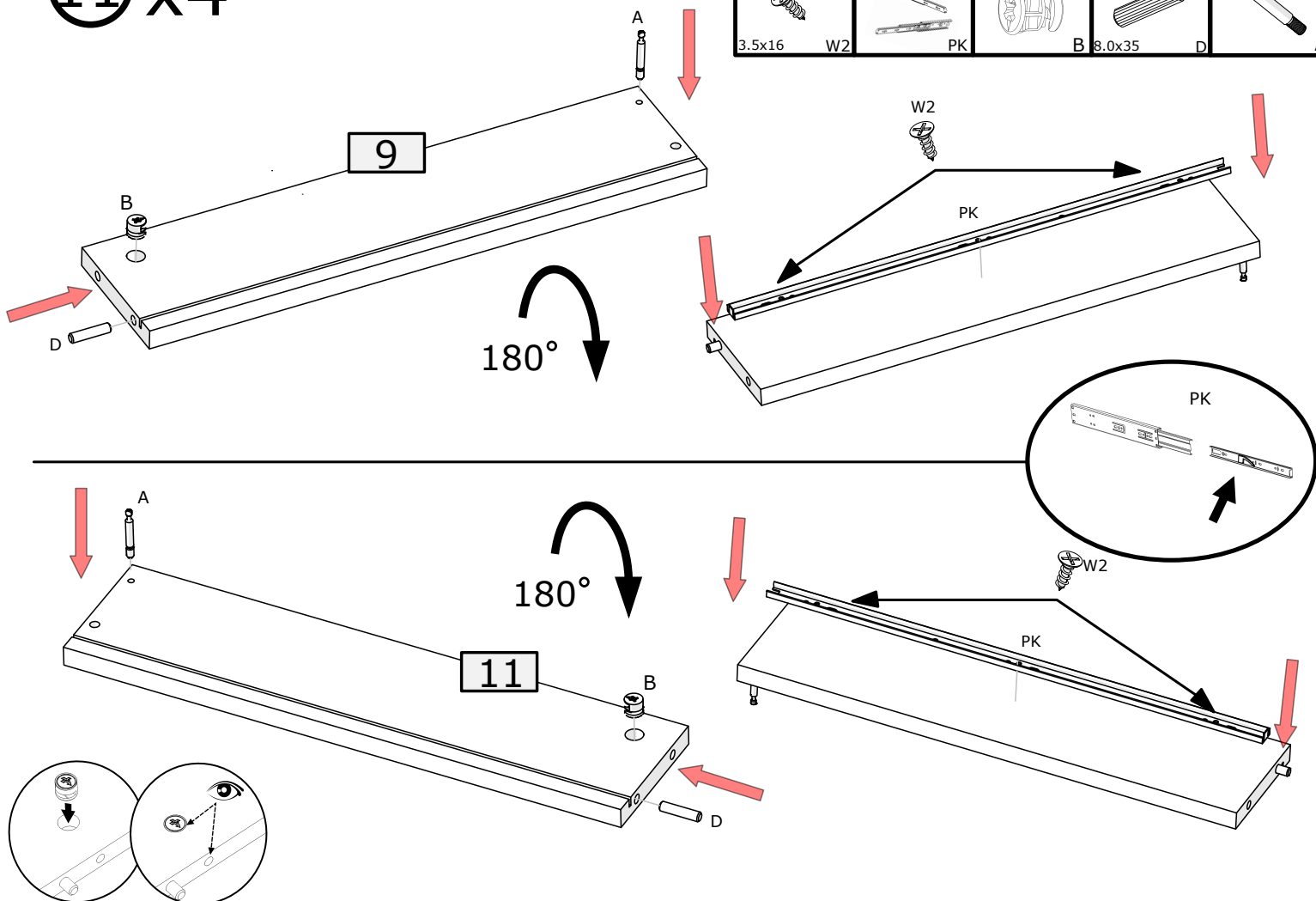

12

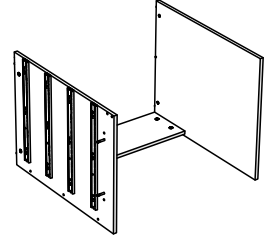
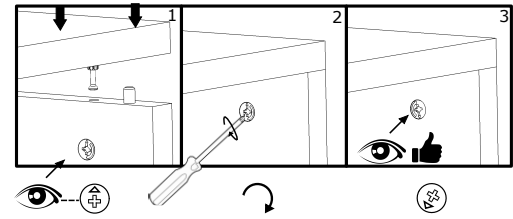
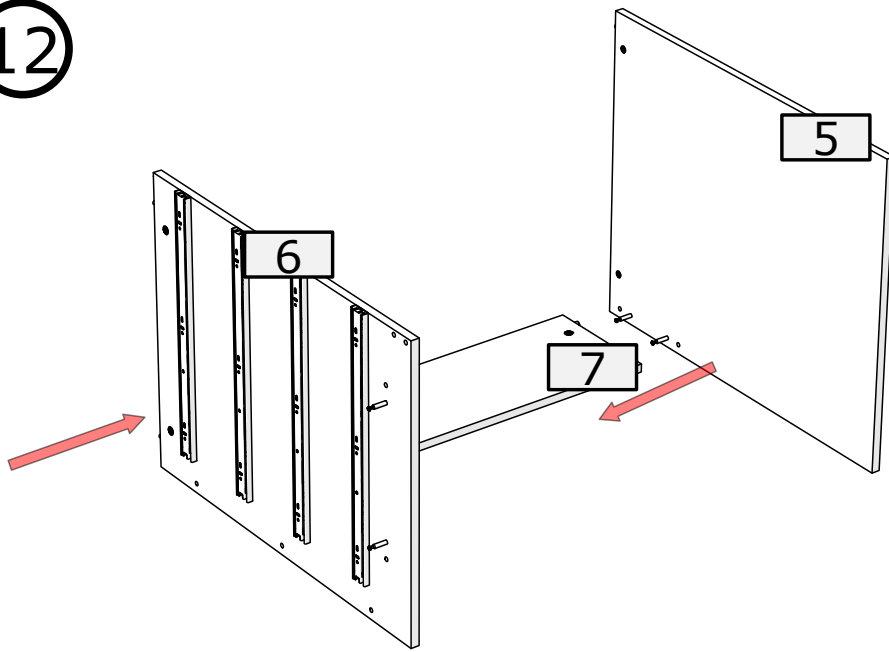

13

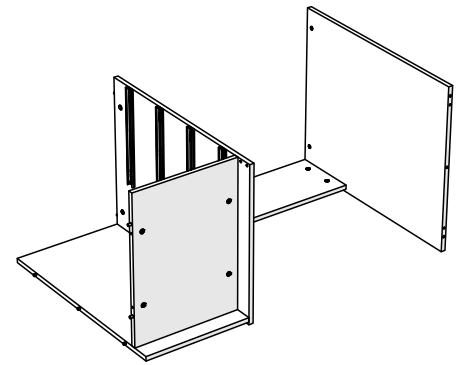
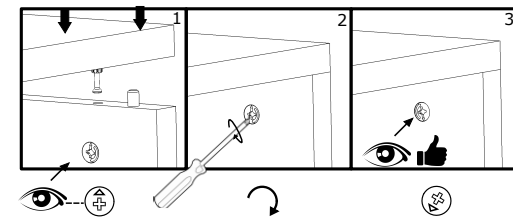
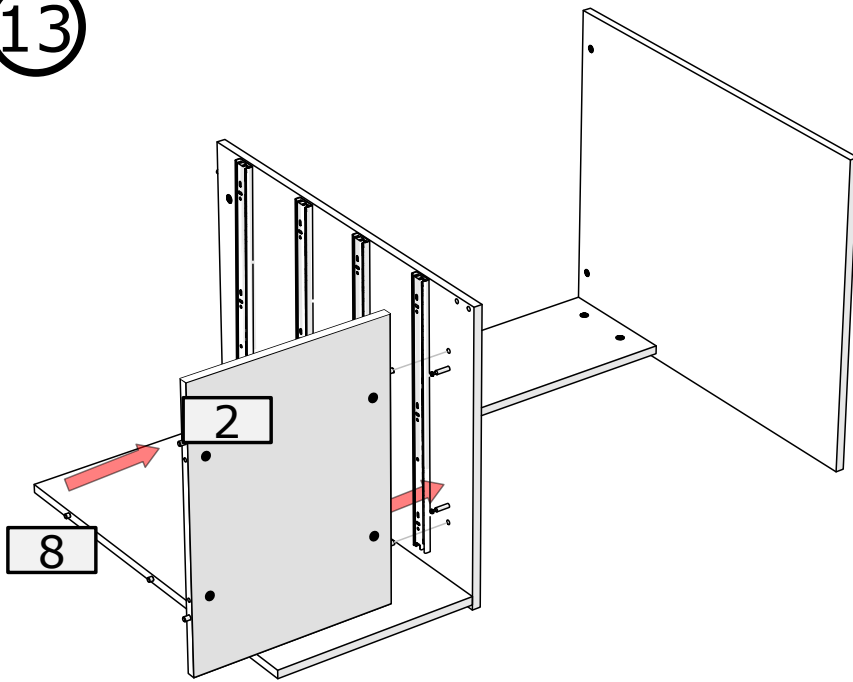

14

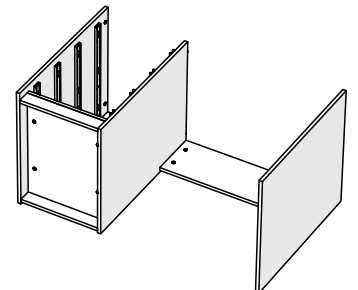
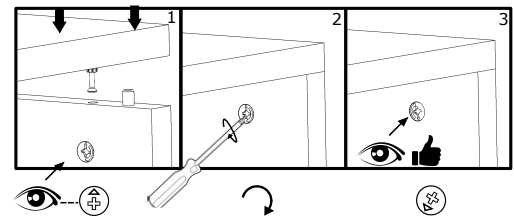
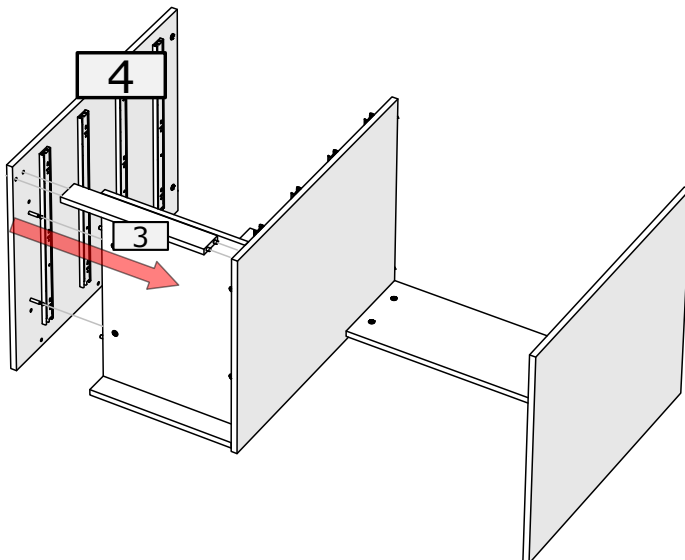

15

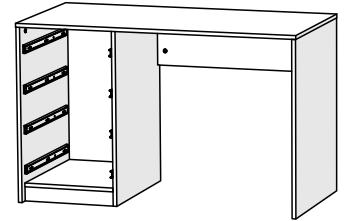
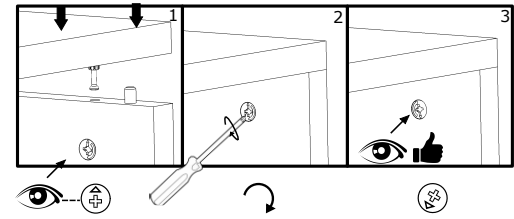
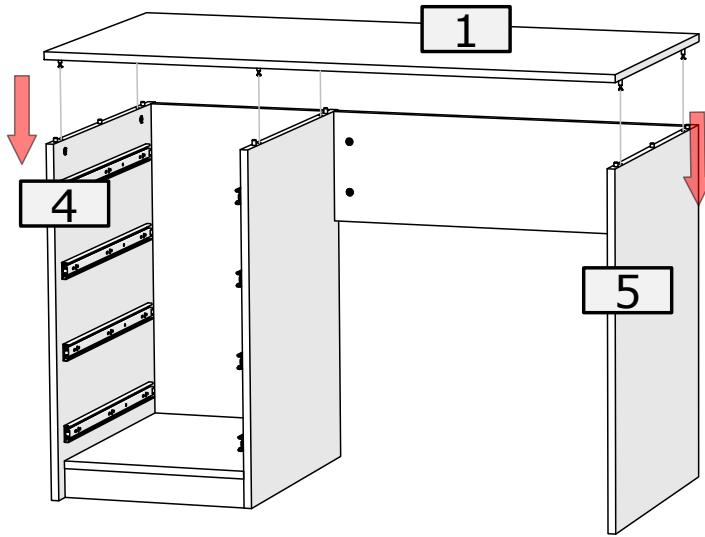

16 x4

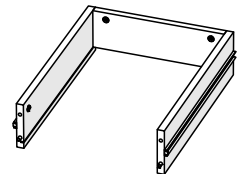
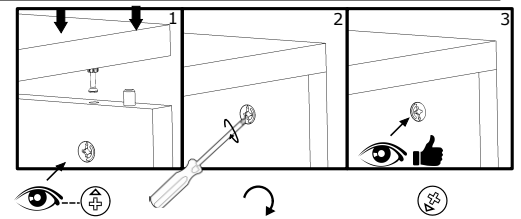
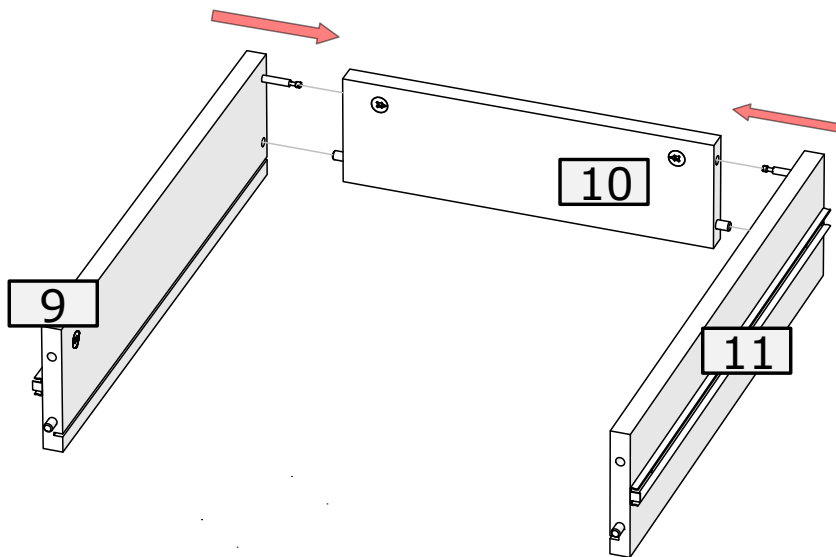

17 x4

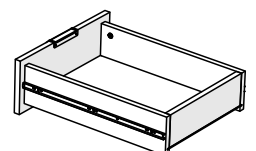
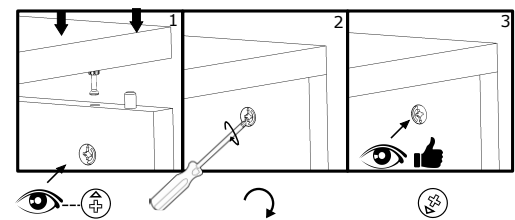
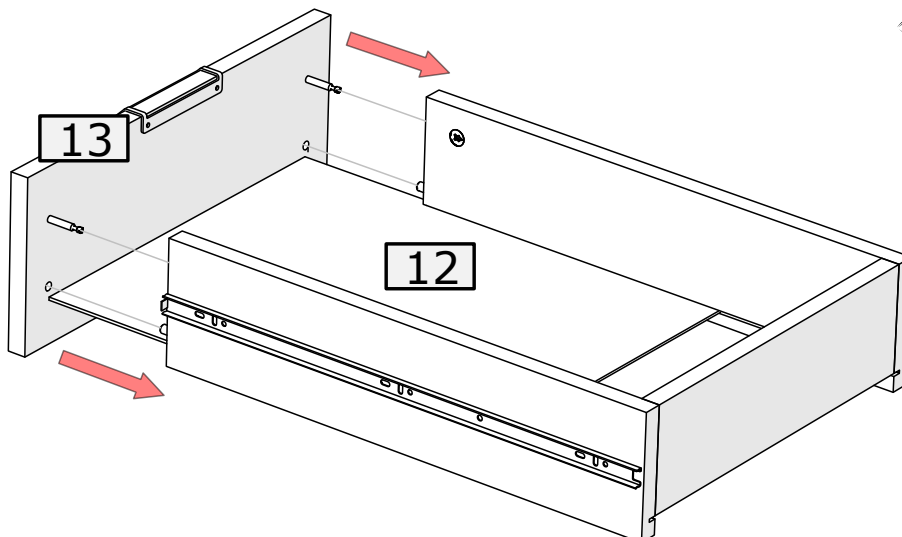

18 x4



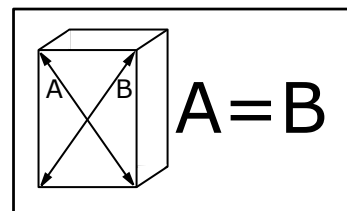
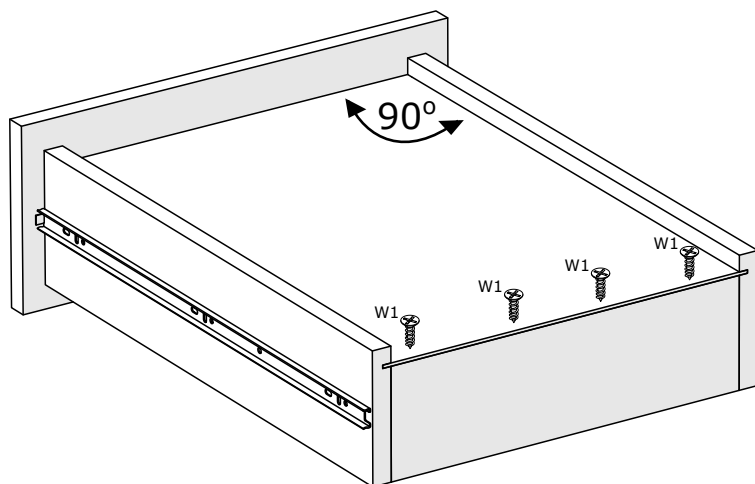

3.0x20 W1
4

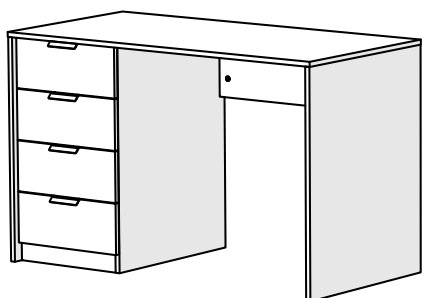
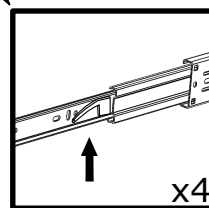
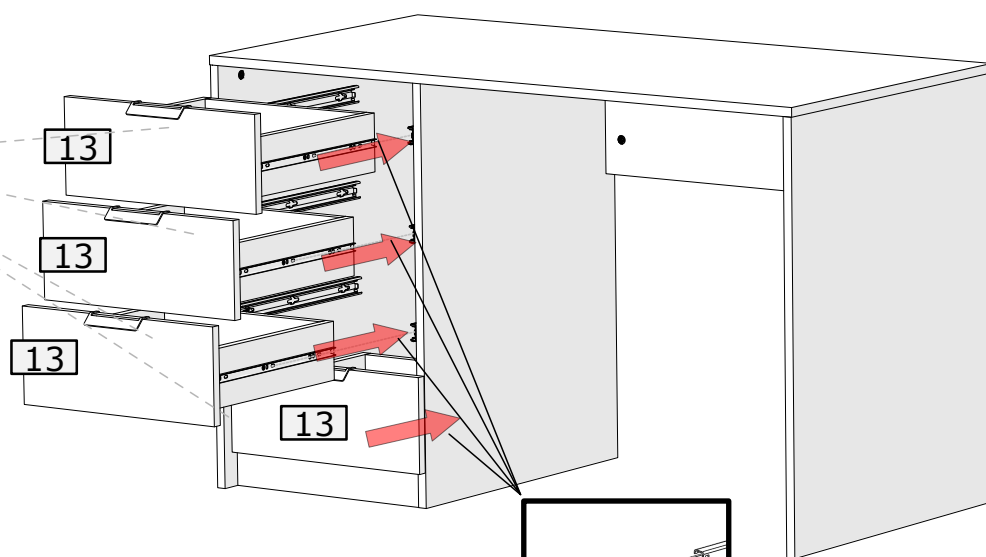
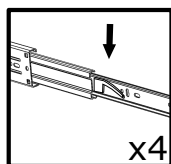

19

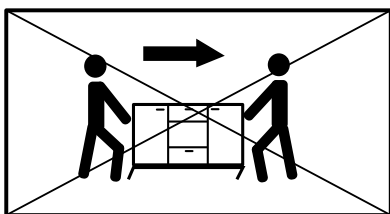
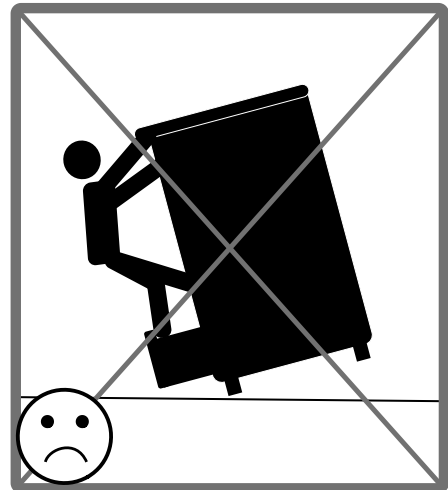
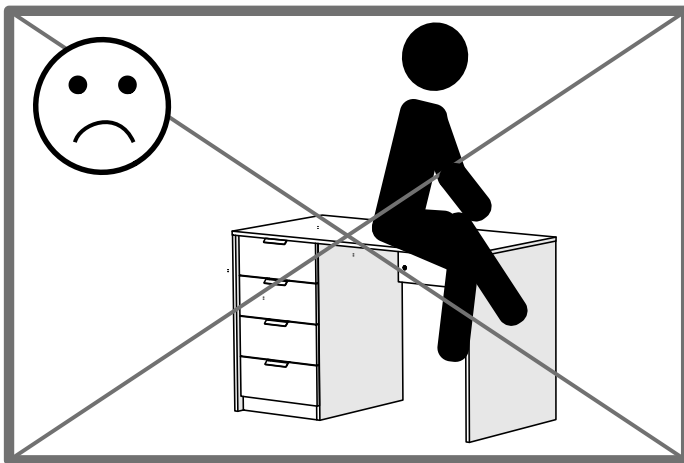
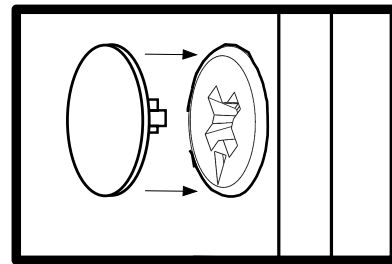
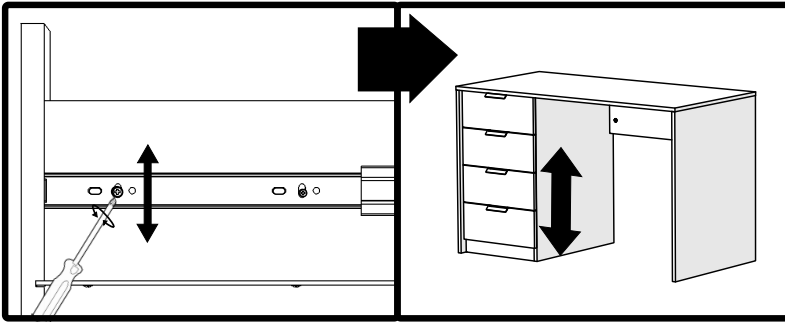
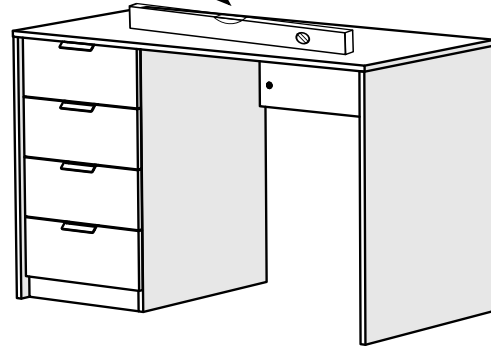
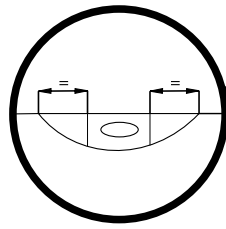

20



×

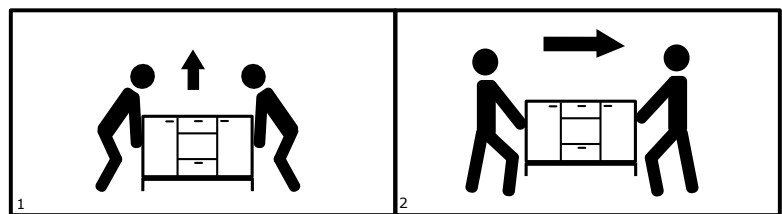

✓