

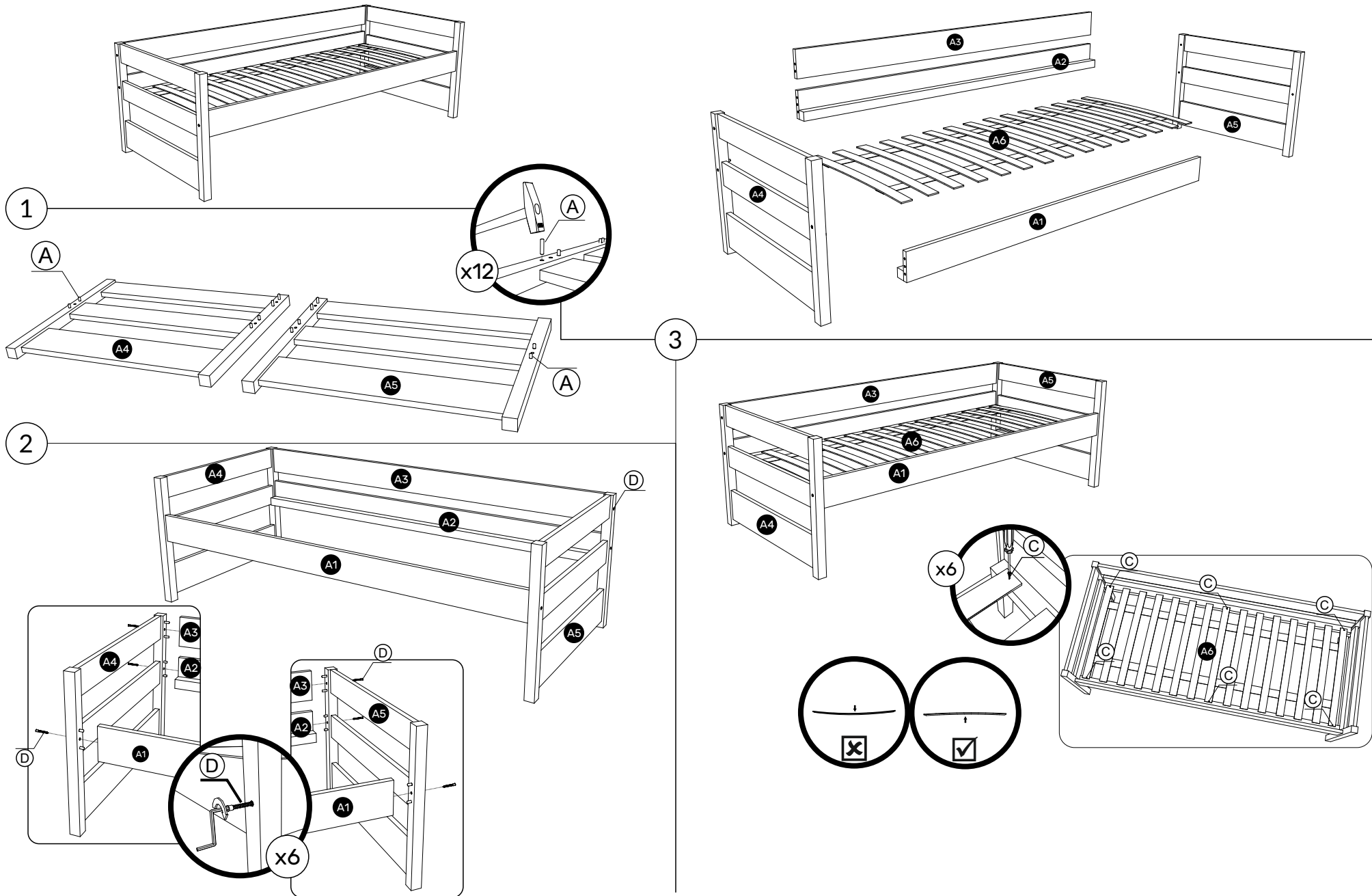

A

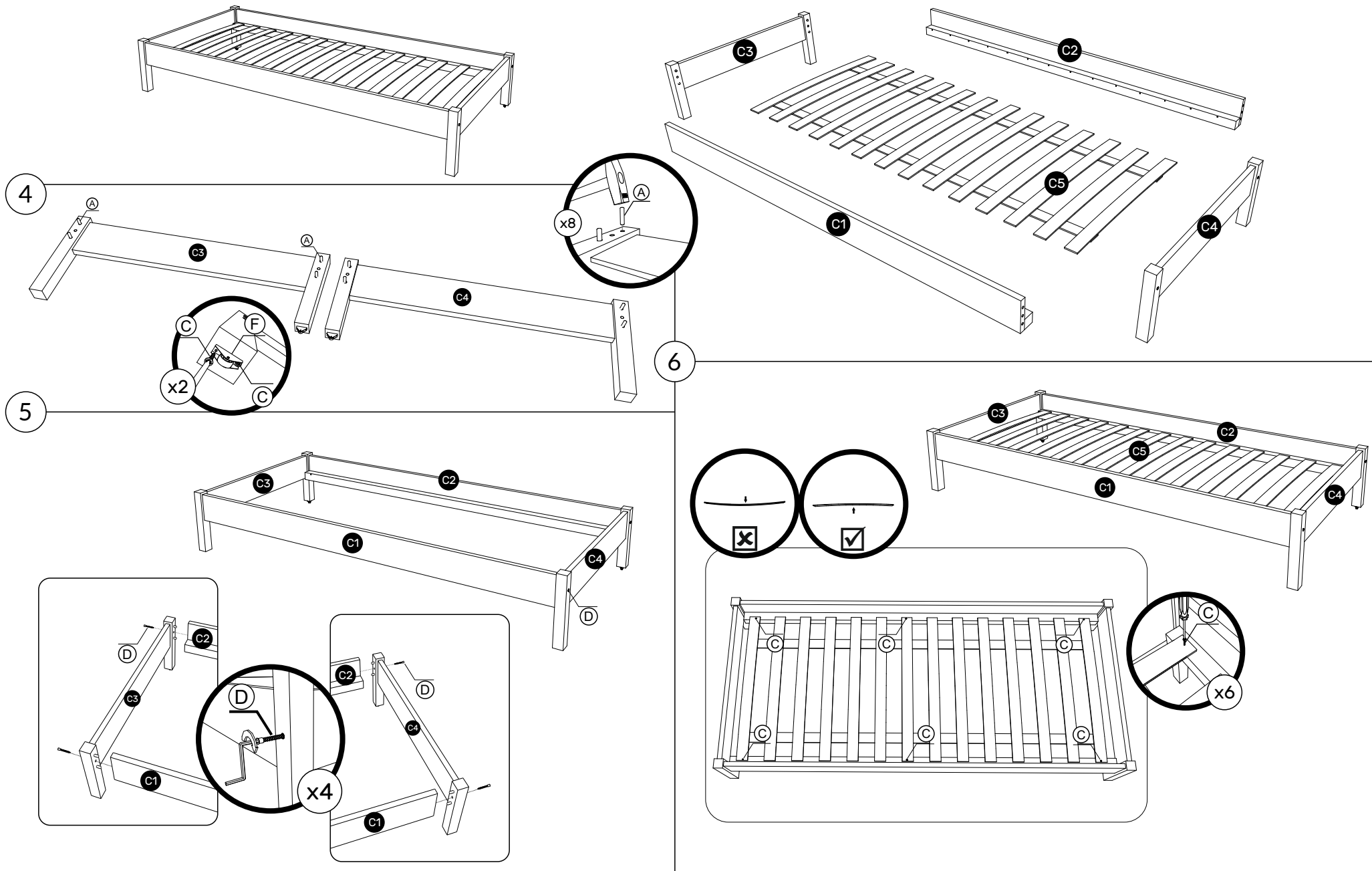

C



D

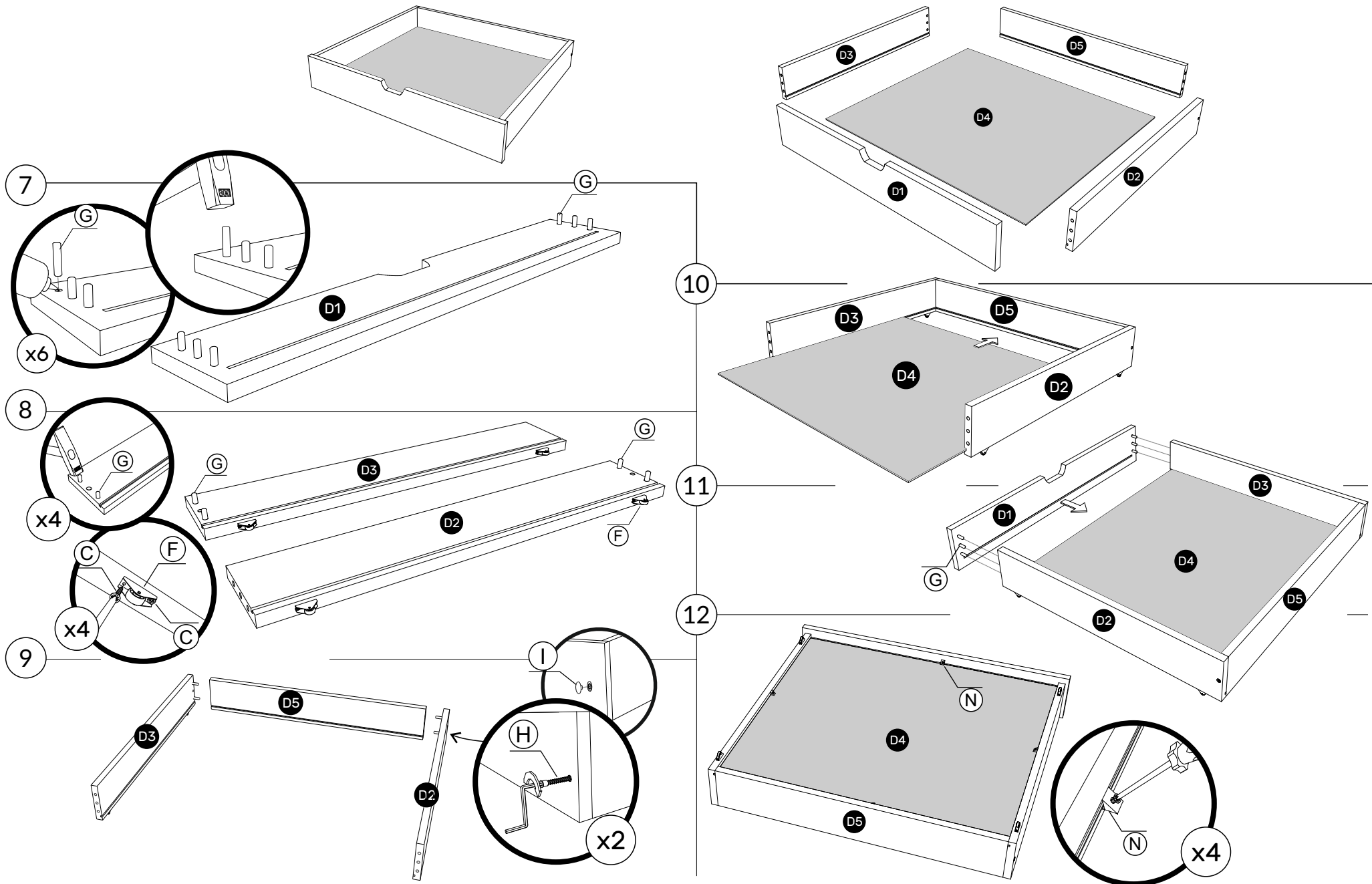

13

A + C

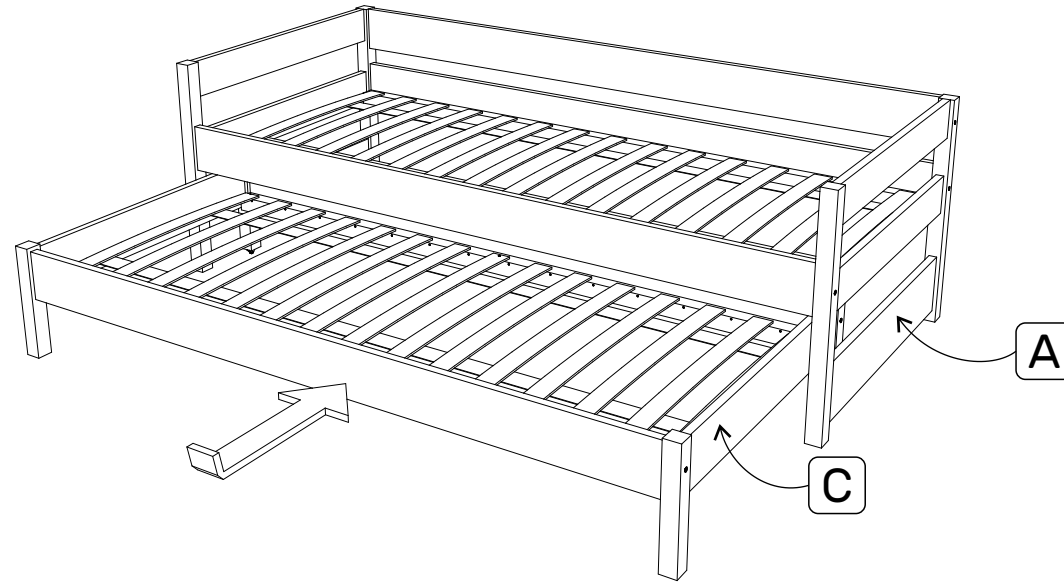

14

A + C + D

