

HAIDAR 180

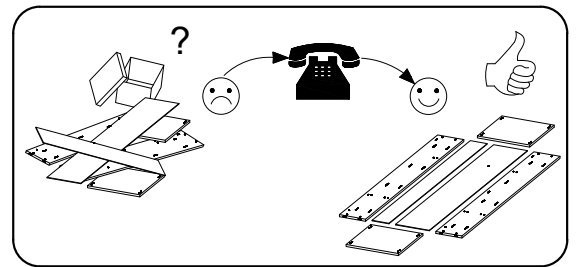

<p>8x30 D 108</p>	<p>A1 4</p>	<p>Ø15x12 8</p>	<p>X 8</p>	<p>X1 40</p>	<p>8X45 D1 4</p>
<p>7x50 O 40</p>	<p>Q 1</p>	<p>5x13 F1 58</p>	<p>M2 8</p>	<p>RD 6</p>	<p>RG 6</p>
<p>4.0x16 H 20</p>	<p>3.0x13 H3 20</p>	<p>GW 21</p>	<p>KP 12</p>	<p>S 12</p>	<p>3.5x16 H1 18</p>
<p>6,3x13 F2 12</p>	<p>U 4</p>	<p>I 27</p>	<p>KL 5</p>		

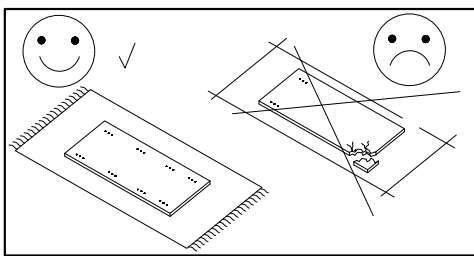

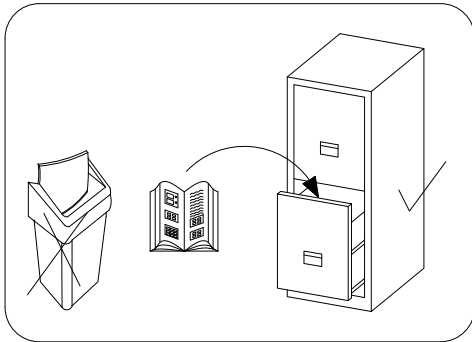
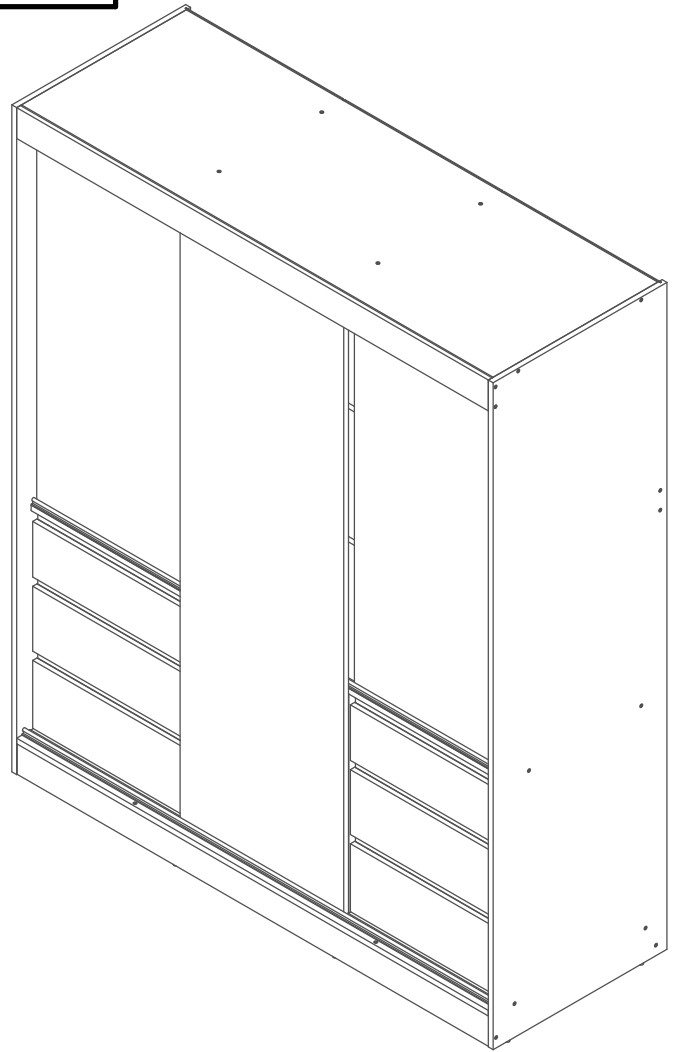
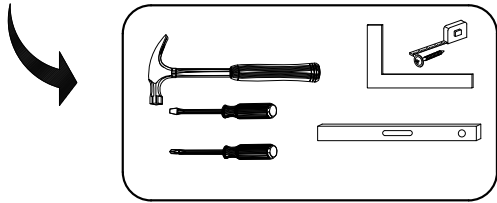
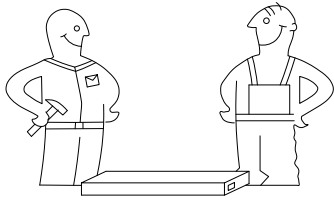
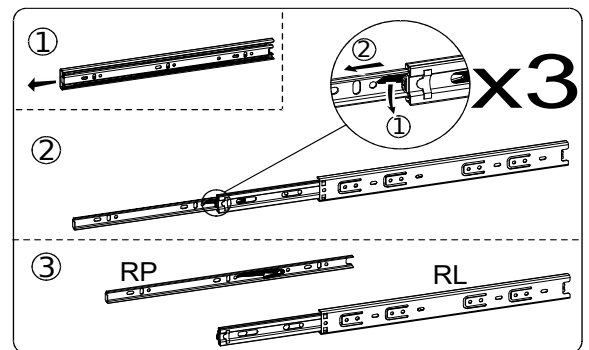
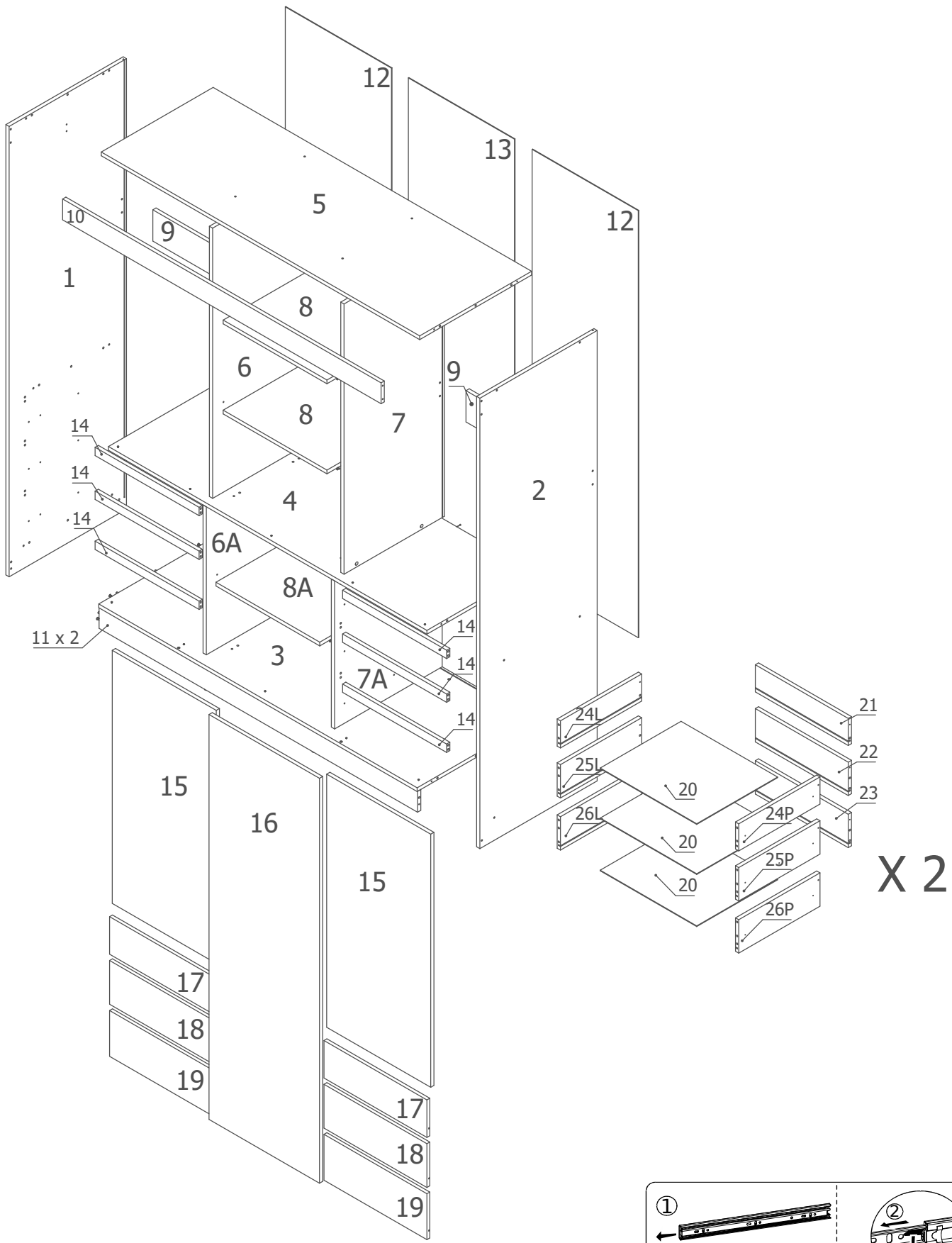
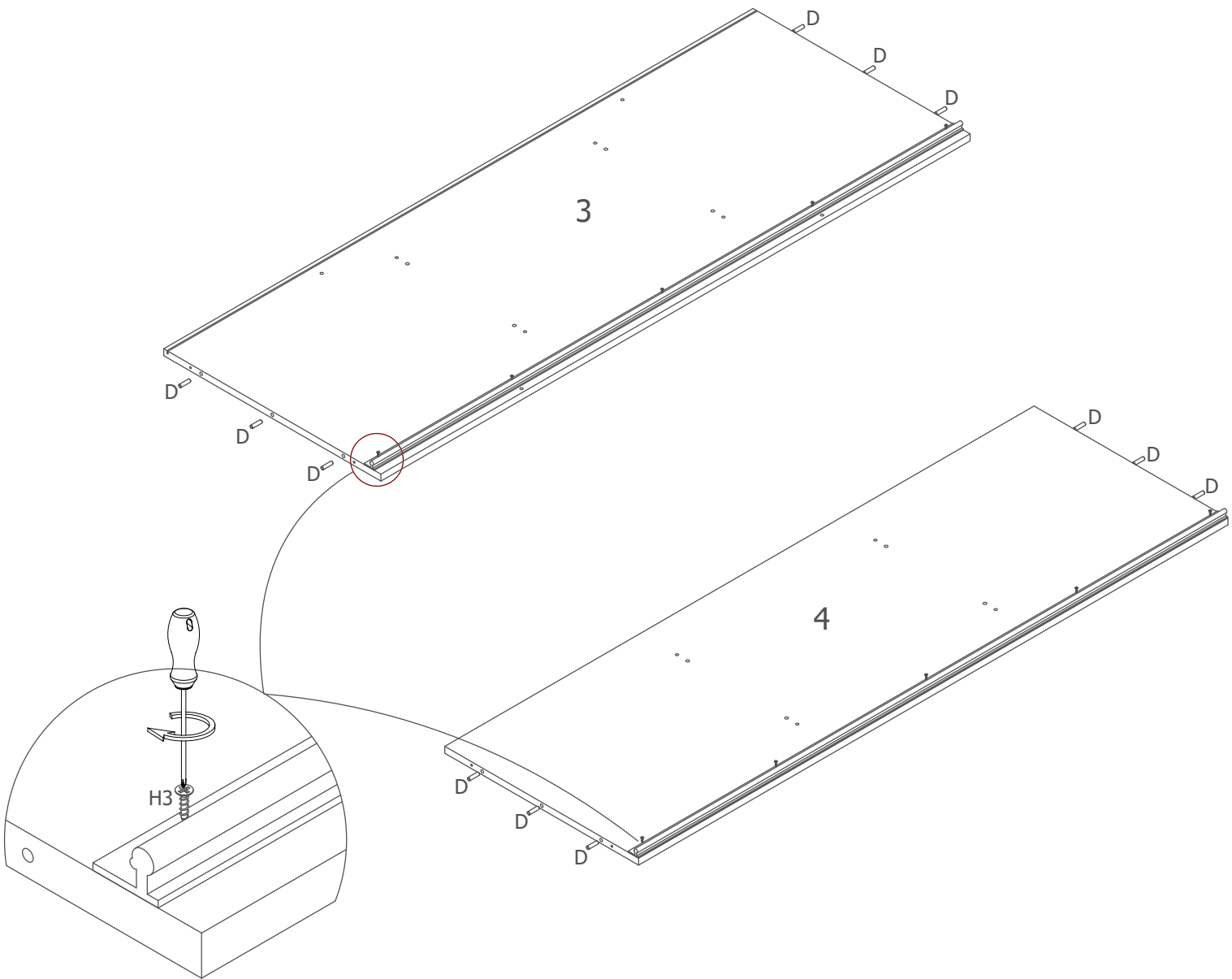
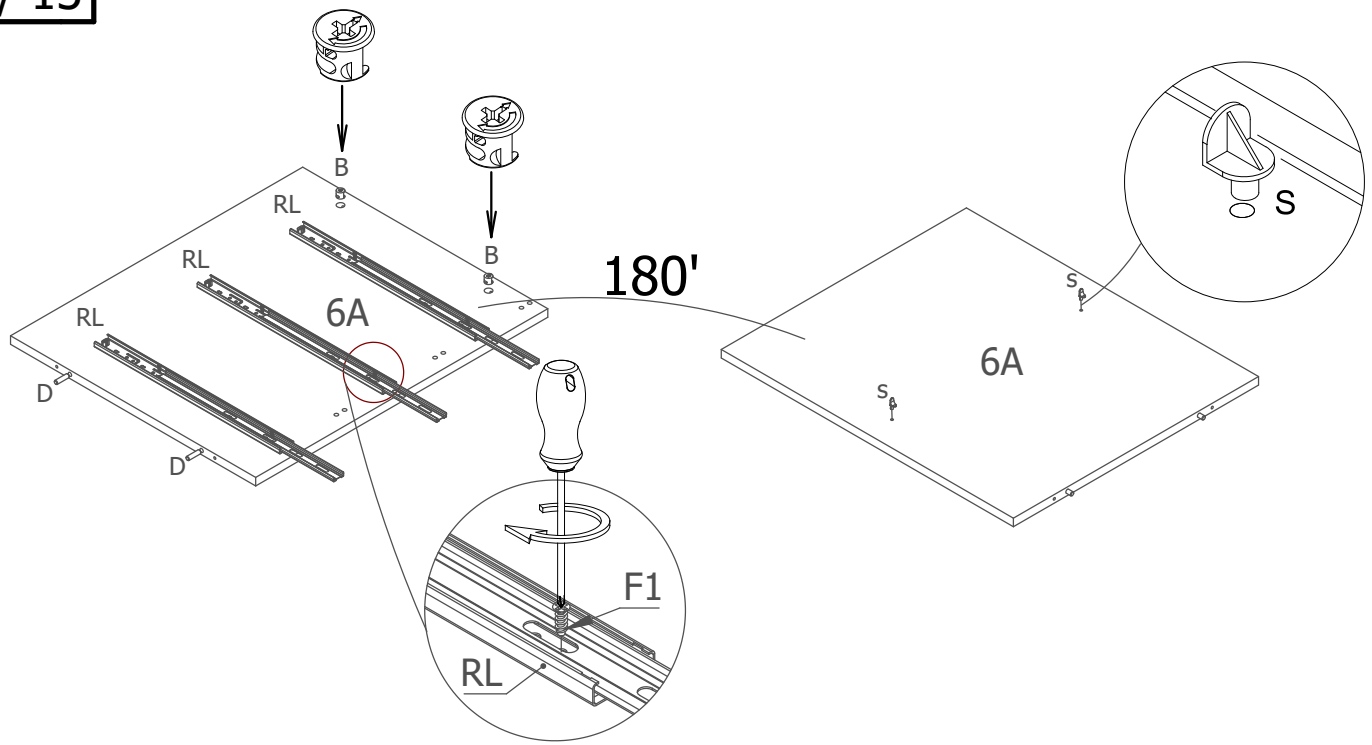

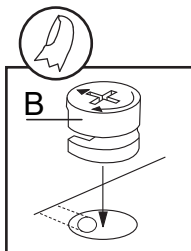
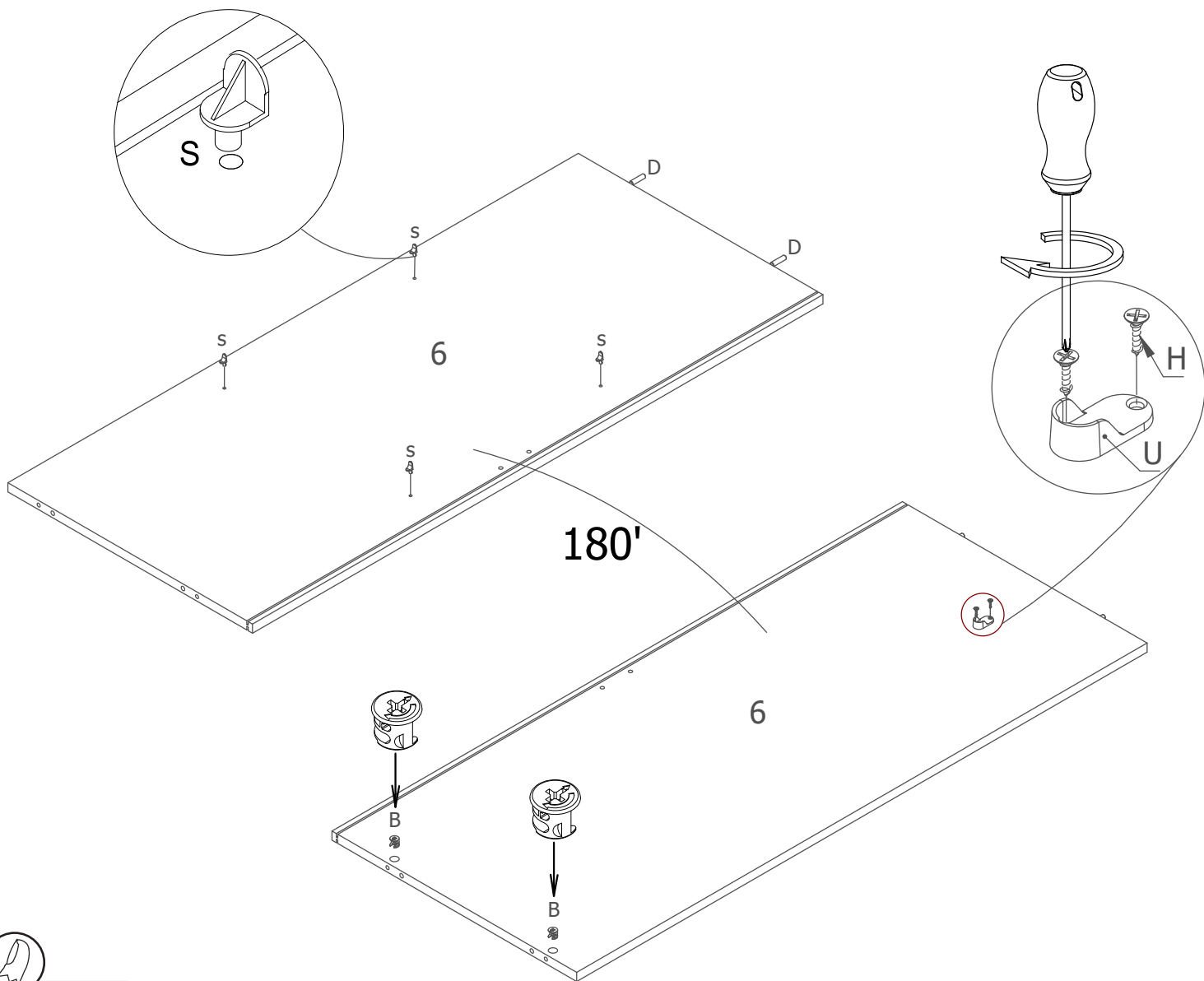
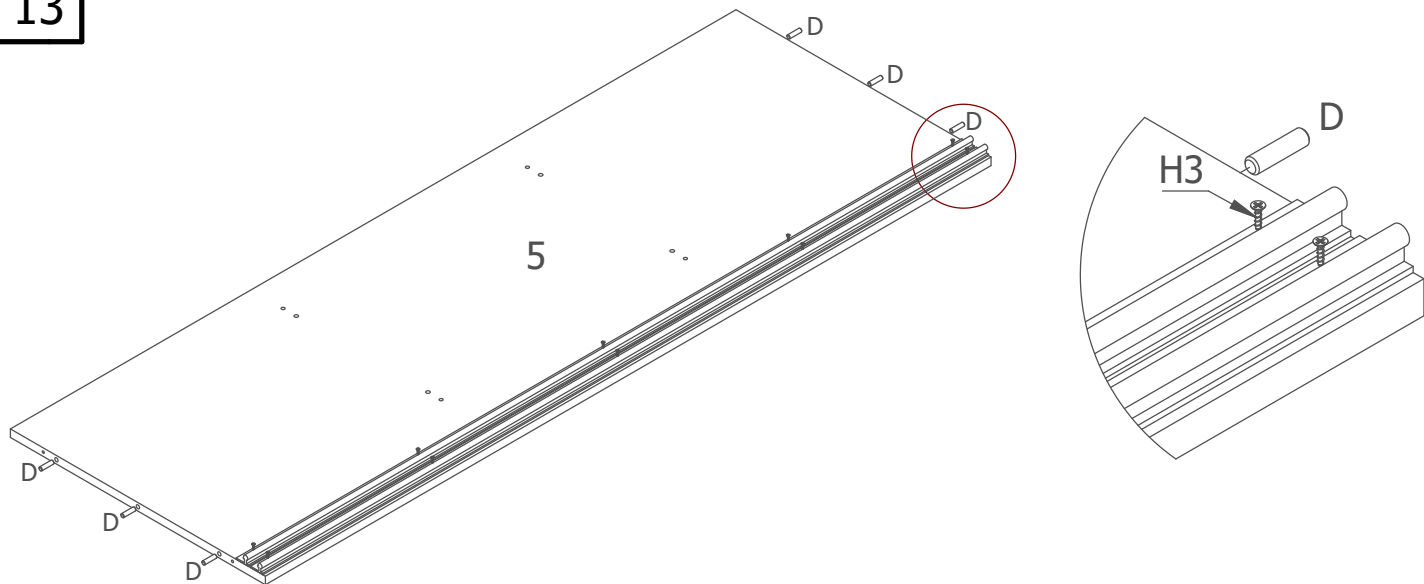

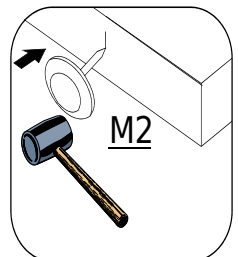
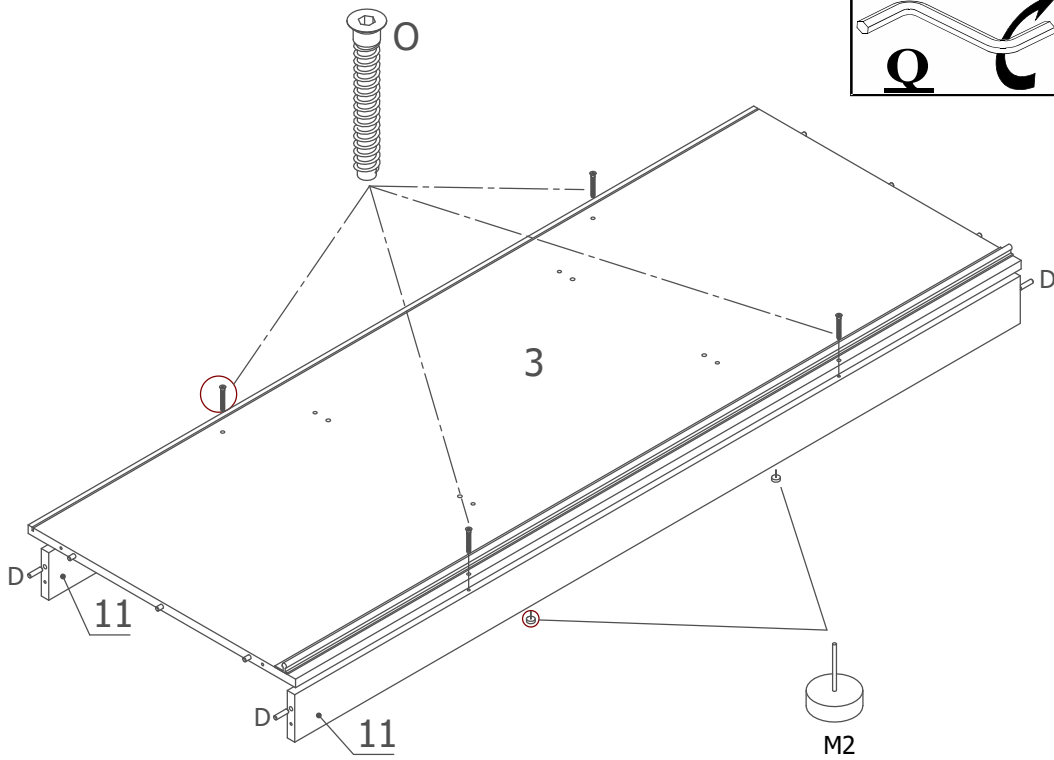
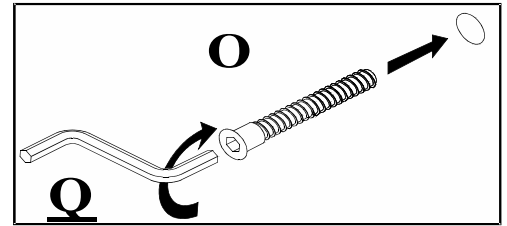
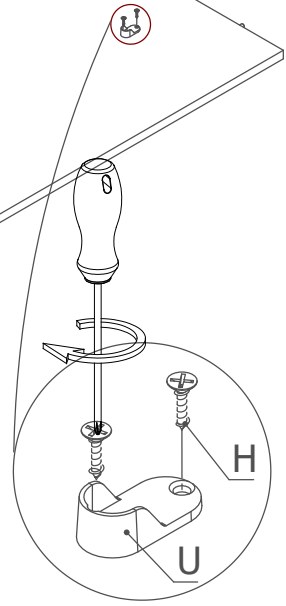
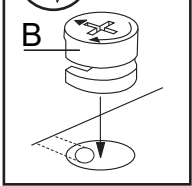
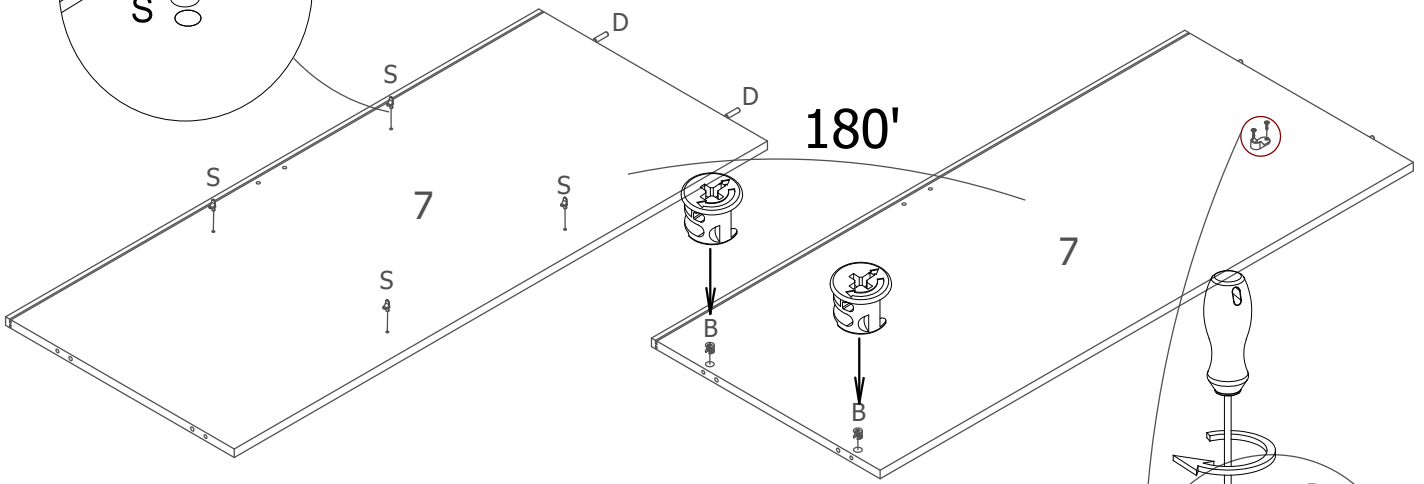
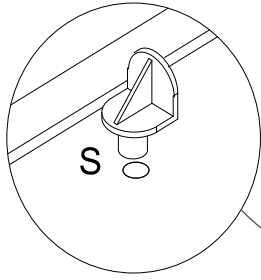

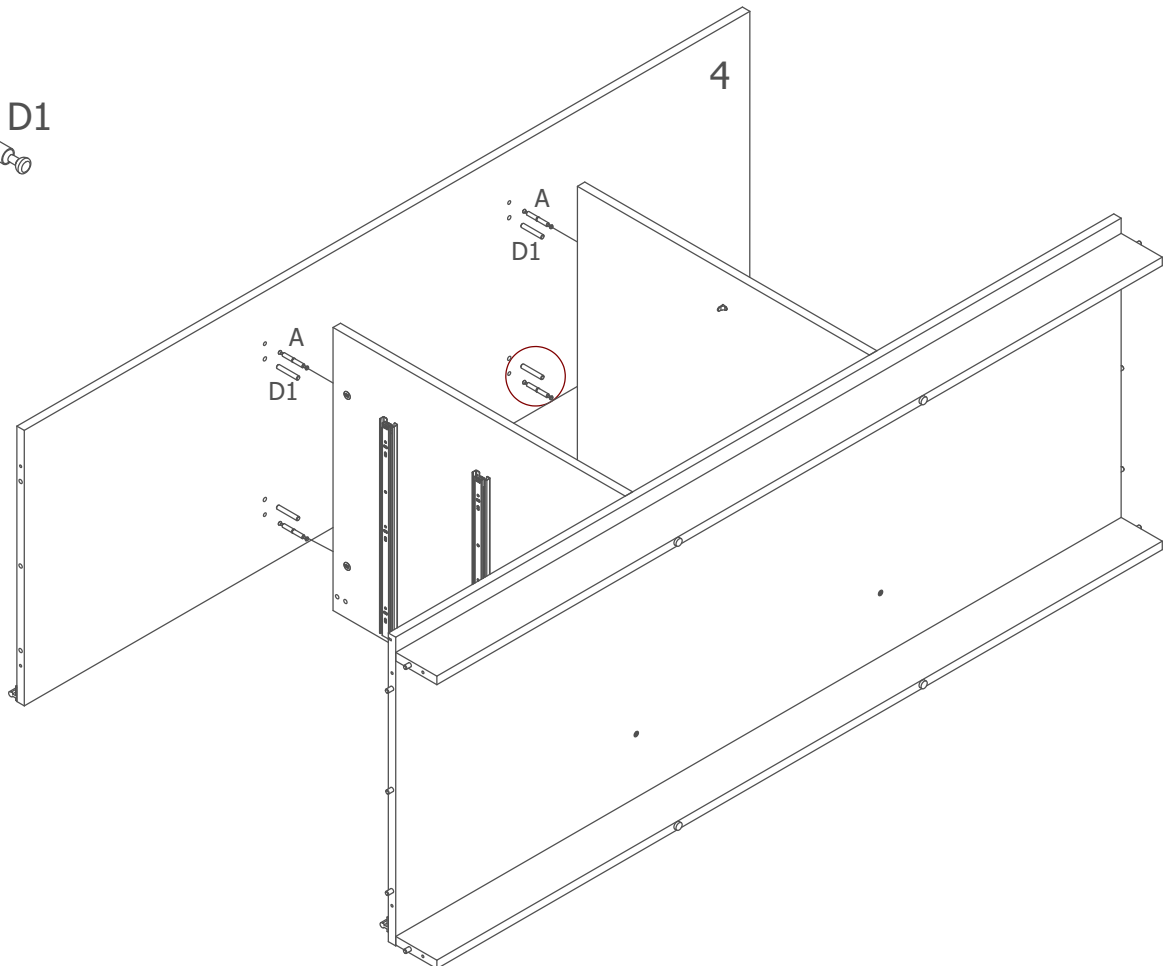
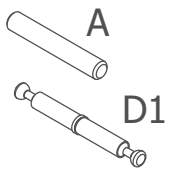
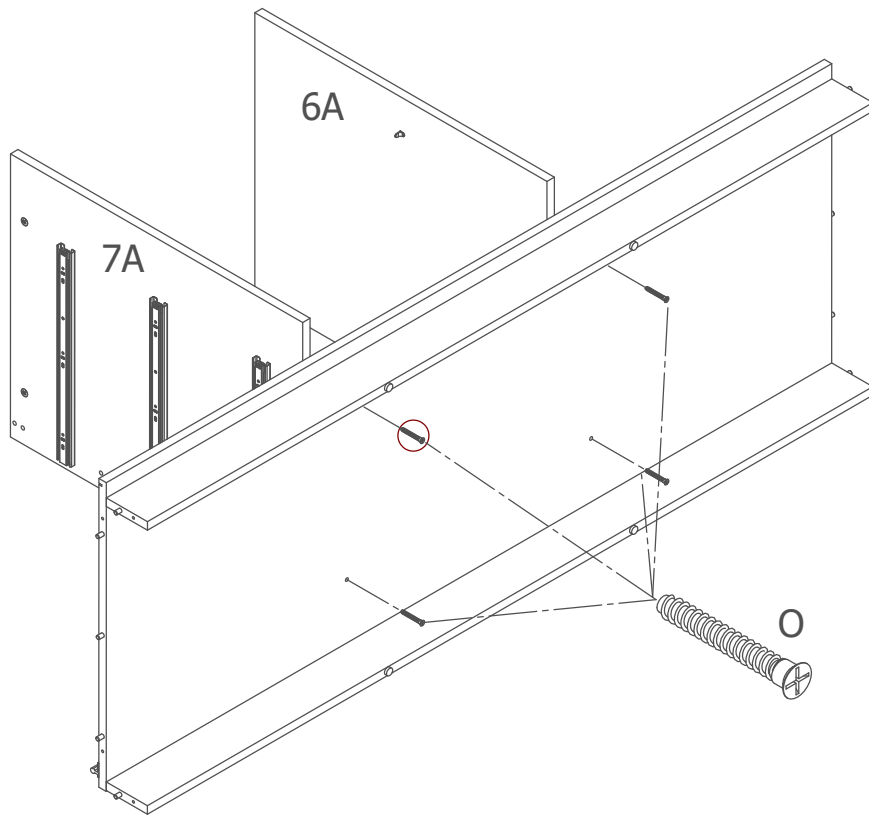
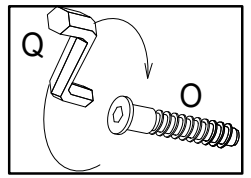

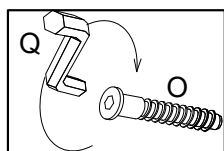
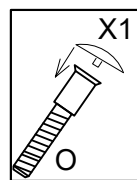
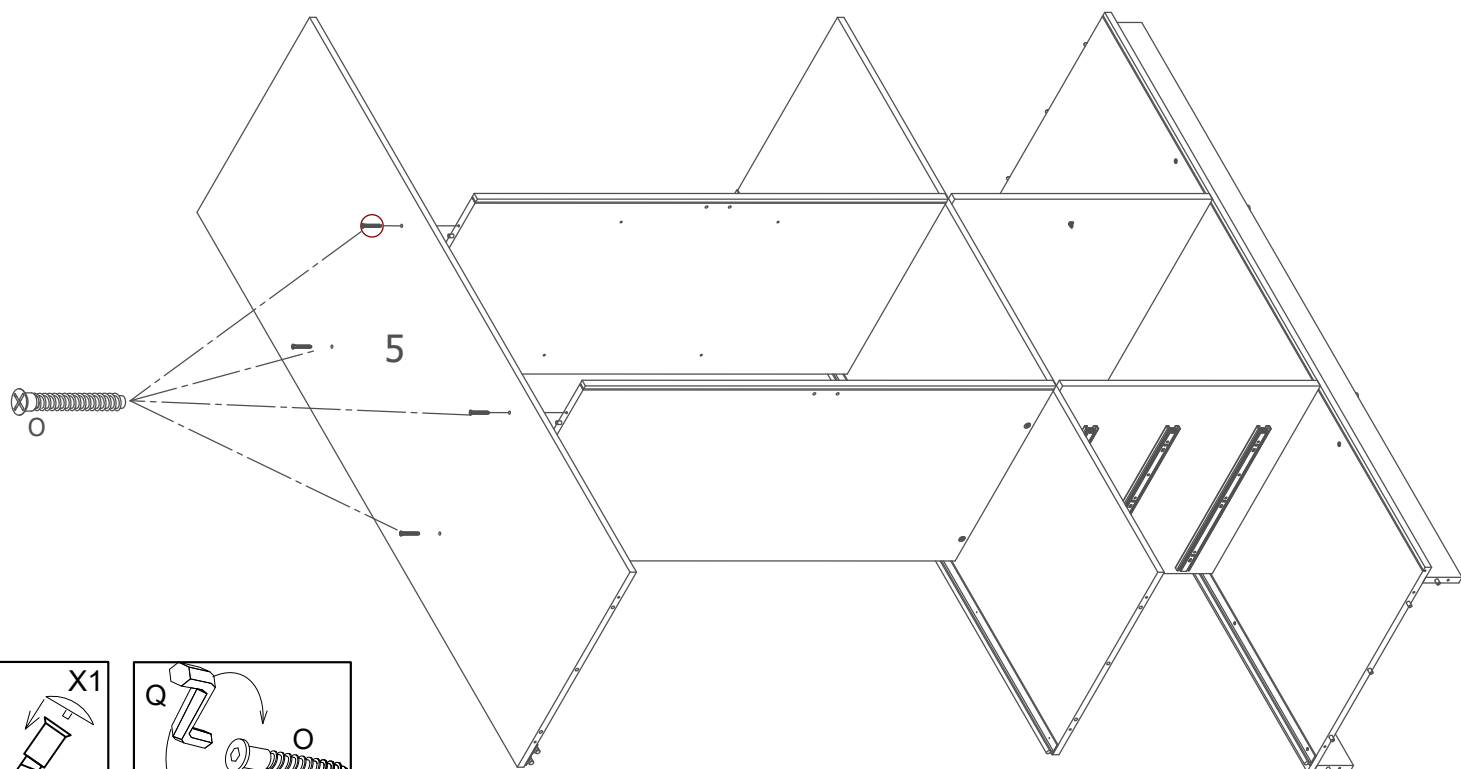
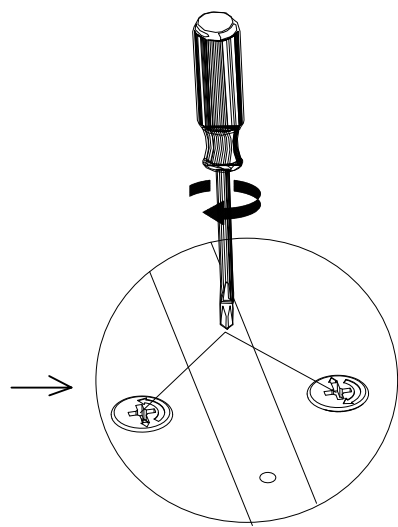
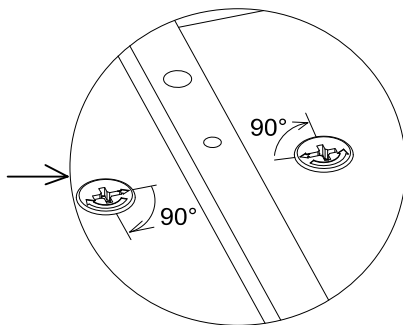
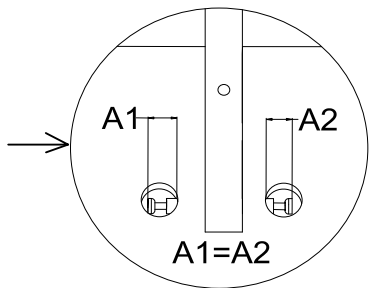
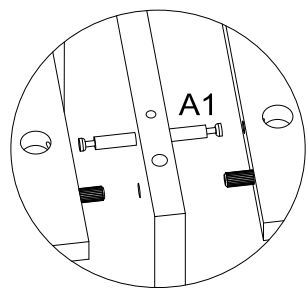
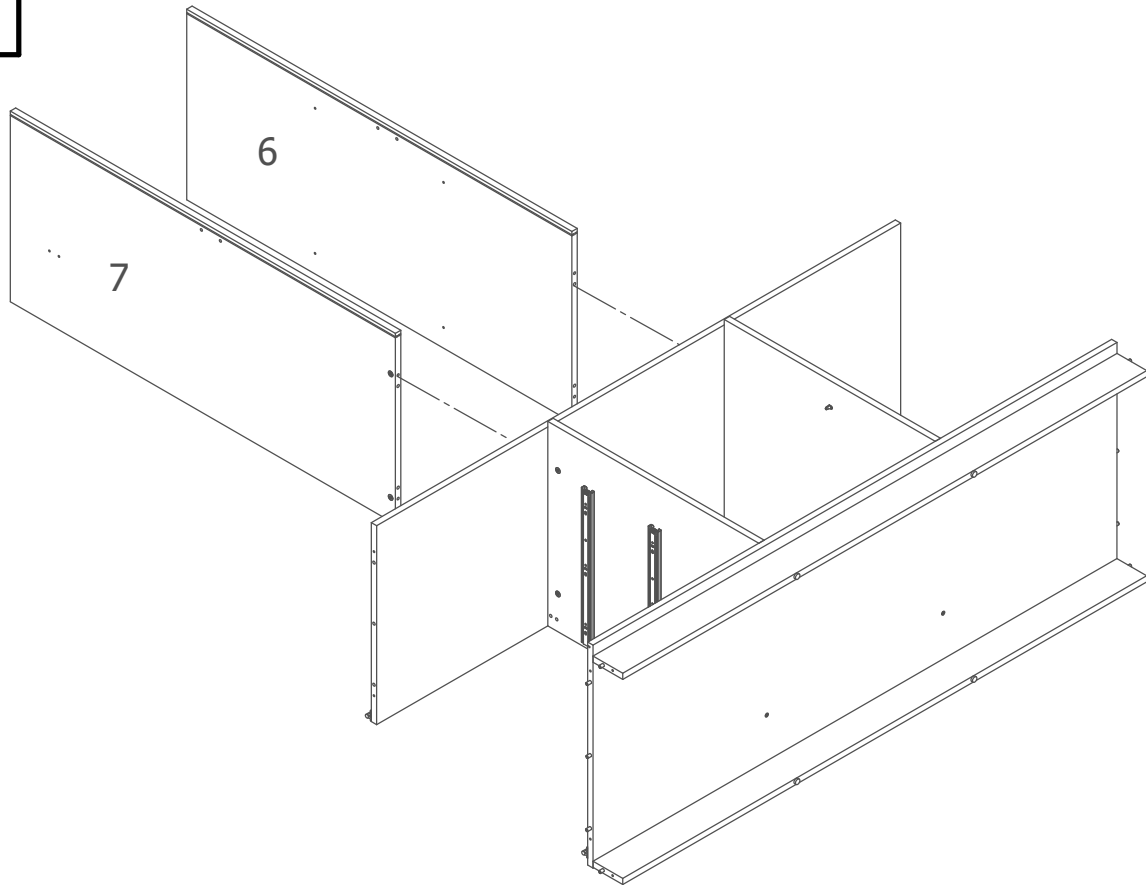

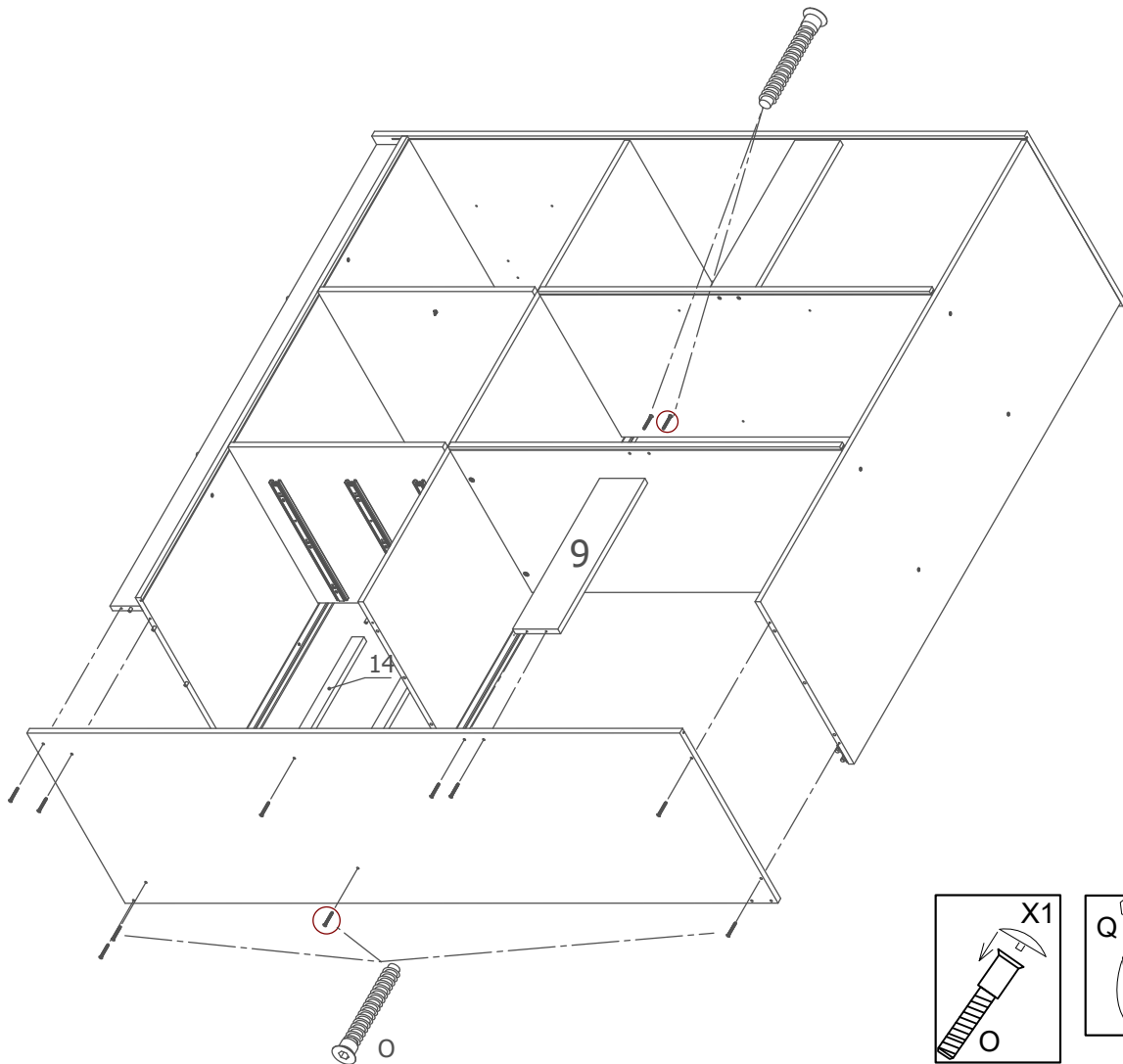
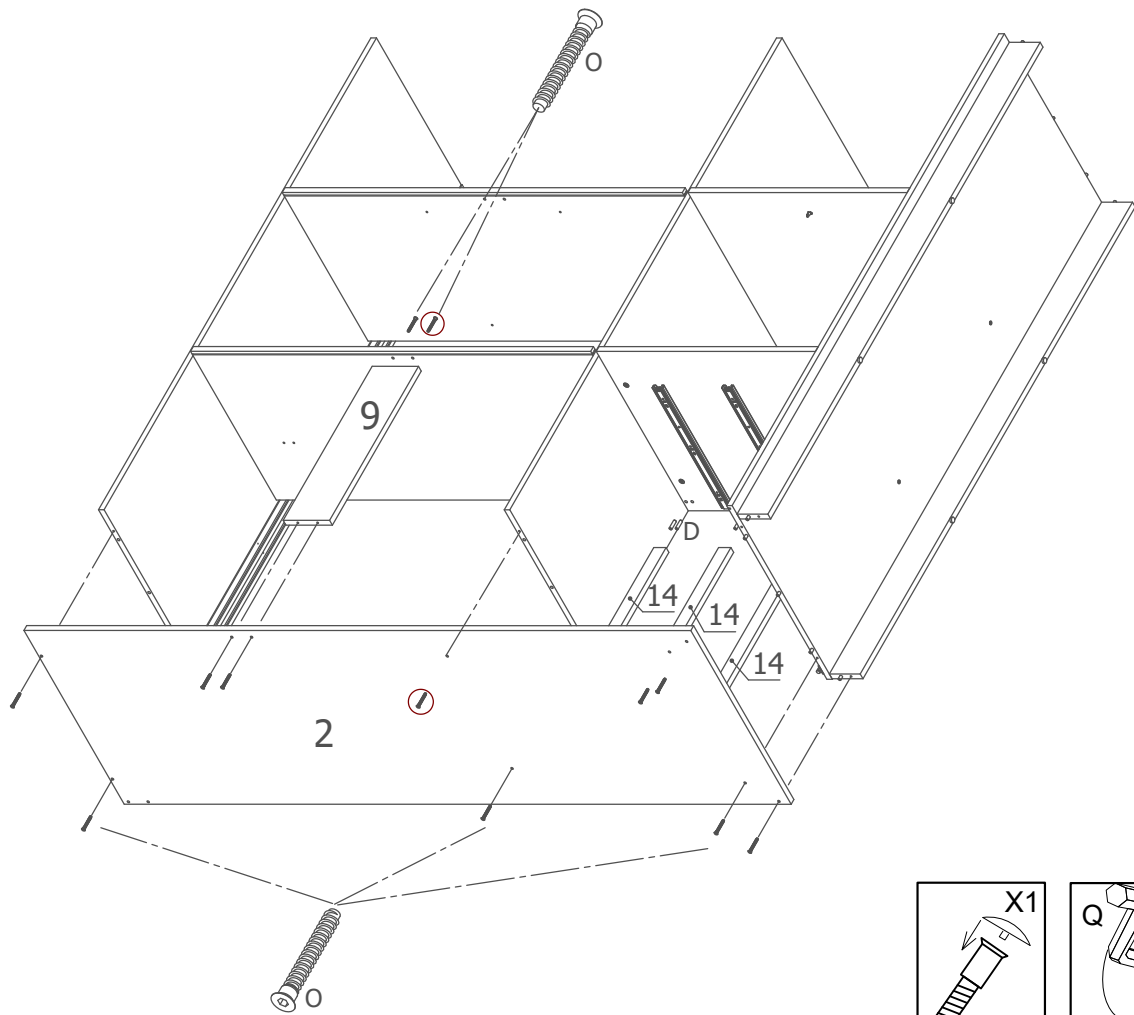

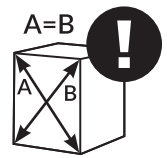
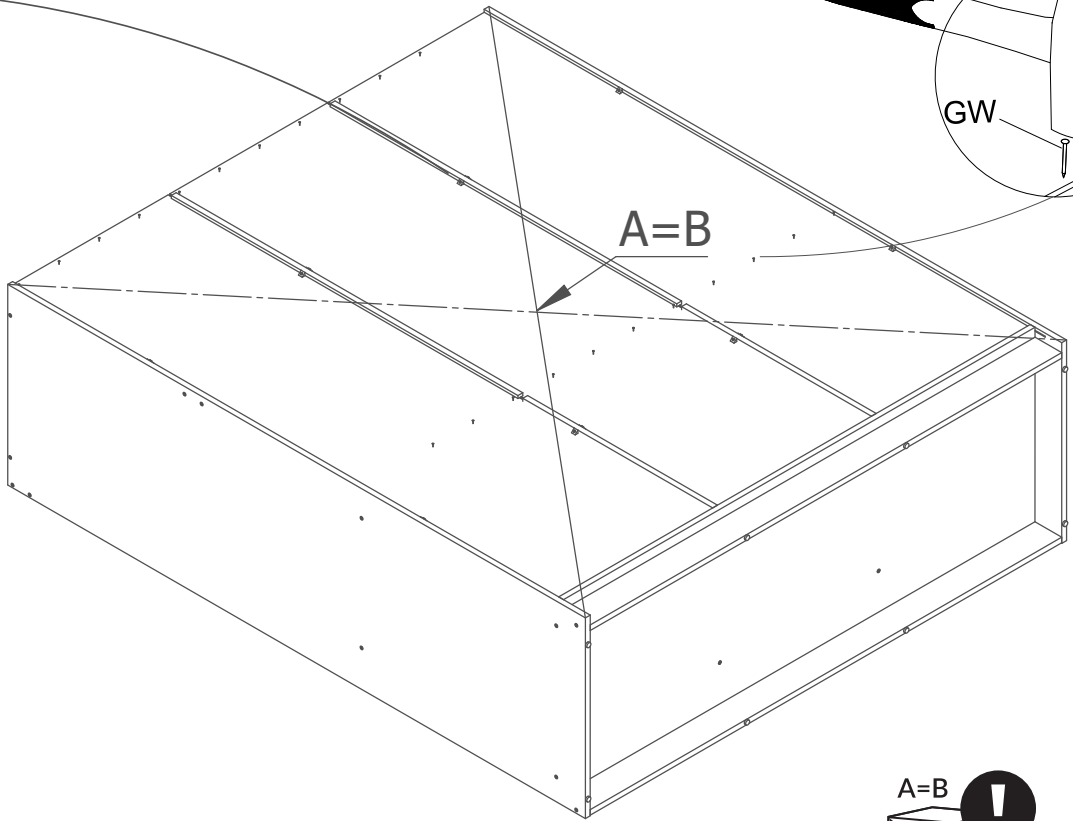
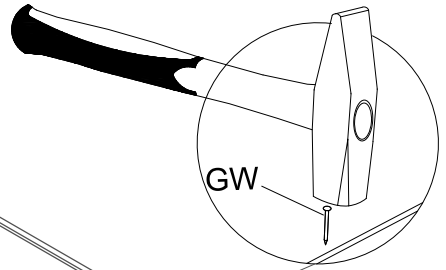
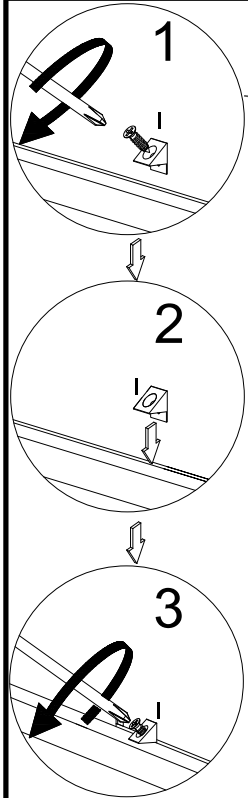
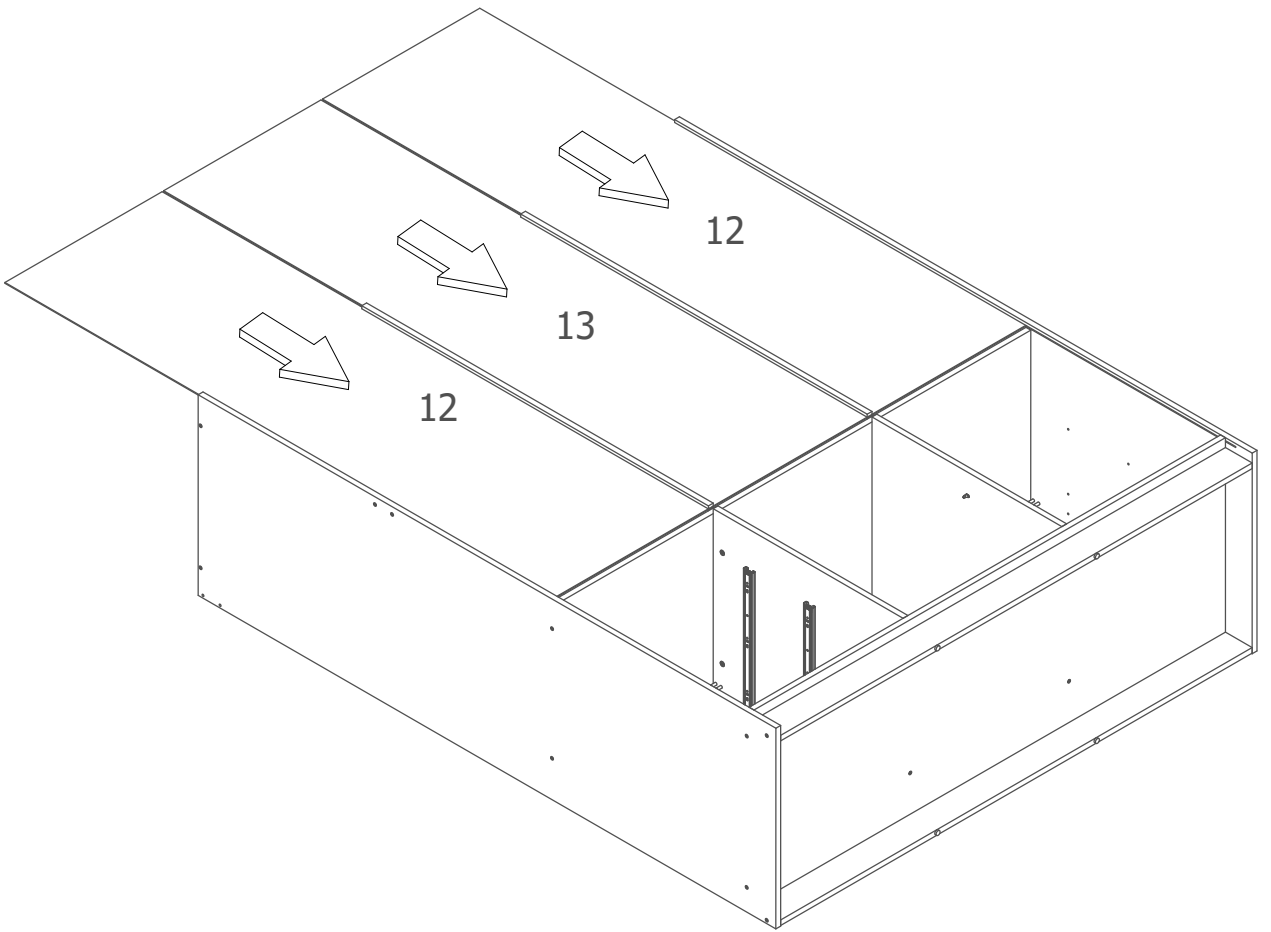

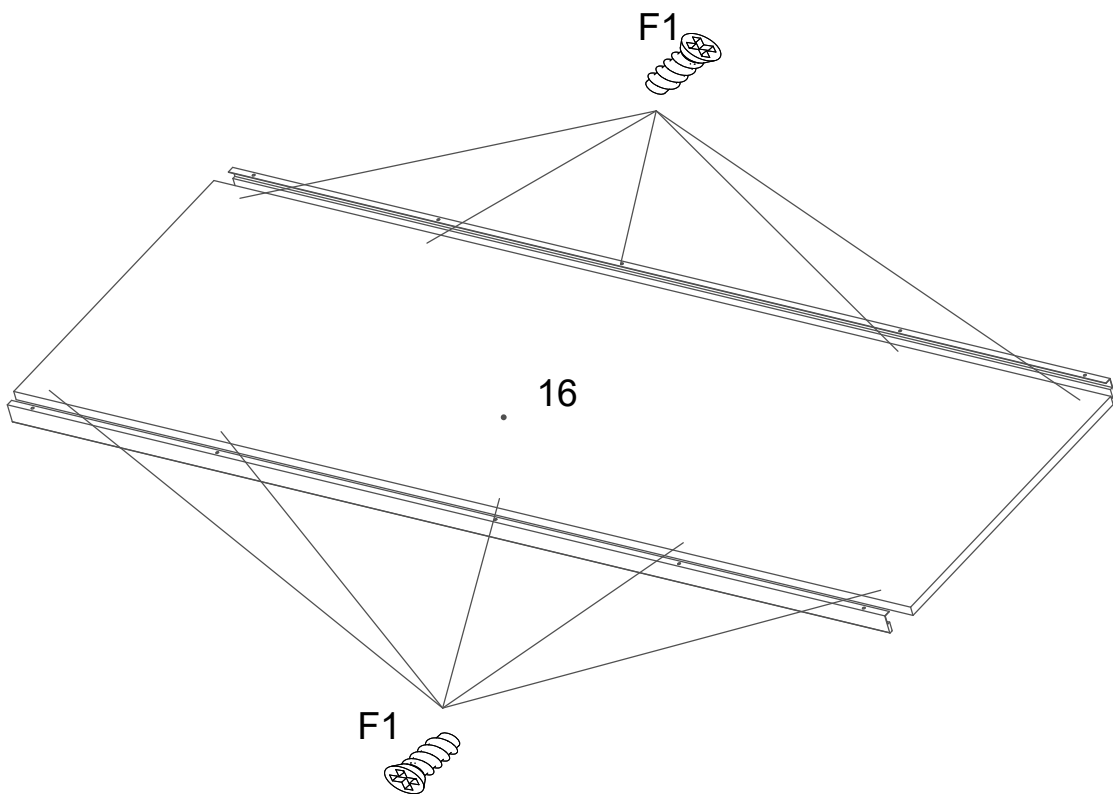
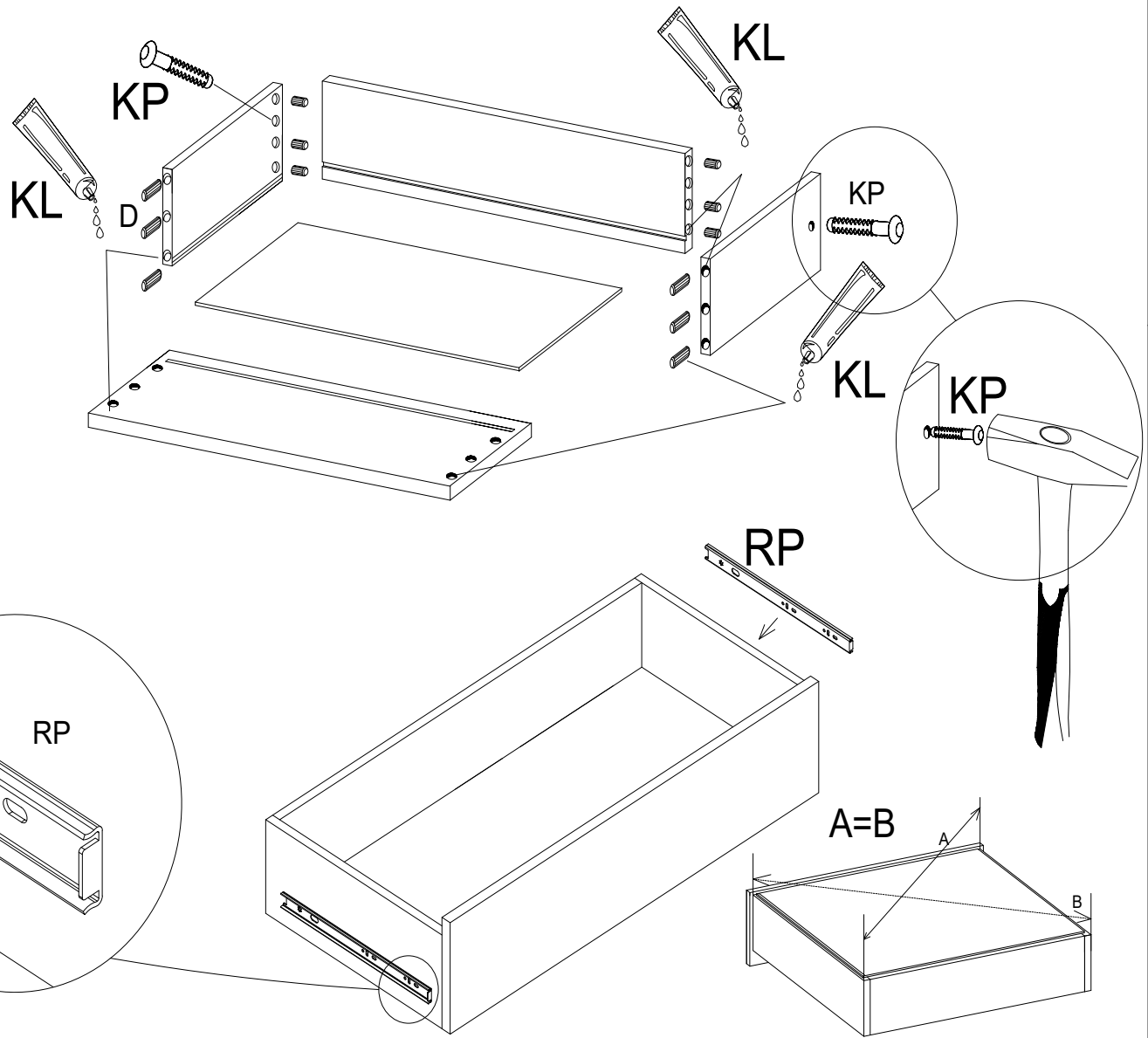

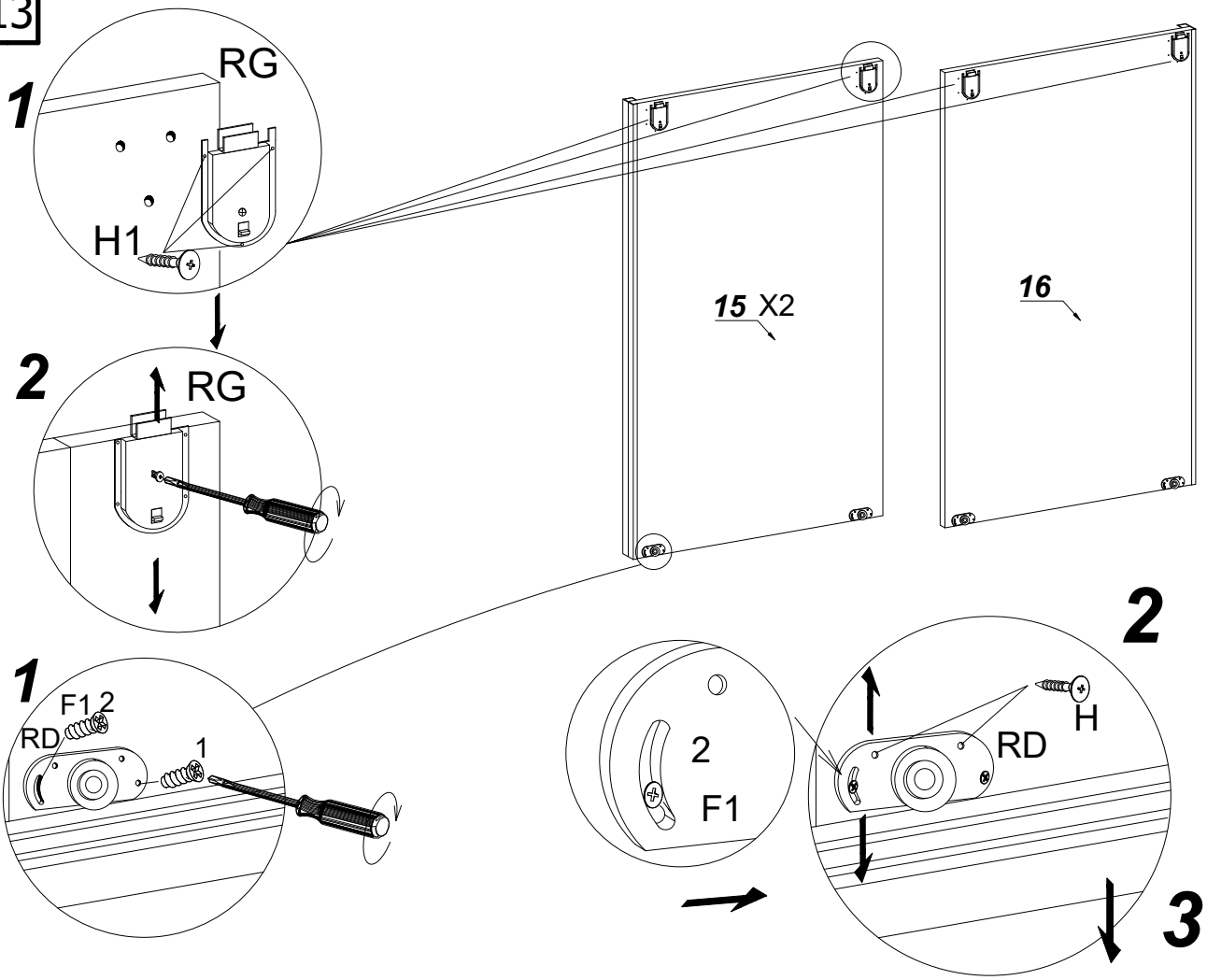

1. ADJUST THE DOOR
2. SCREW IN THE „H” ELEMENTS

