

# Szafa 150

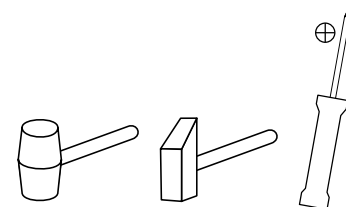

Nr	Nazwa elementu	D[mm]	S[mm]	G[mm]	Ilość
1	Bok L	2150	610	16	1
2	Bok P	2150	610	16	1
3	Wieniec Górny	1468	593	16	1
4	Wieniec Dolny	1468	610	16	1
5	Przegroda Pionowa	1676	470	16	2
6	Przegroda Mała	326	470	16	1
7	Przegroda Pozioma	1468	470	16	1
8	Półka	470	380	16	6
9	Cokół	1468	100	16	1
10	Listwa Maskująca	1468	70	16	1
11	Kapak	2015	742	2,5	2
12	Drzwi L	2005	750	16	1
13	Drzwi P	2005	750	16	1

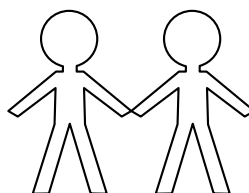
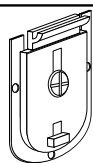
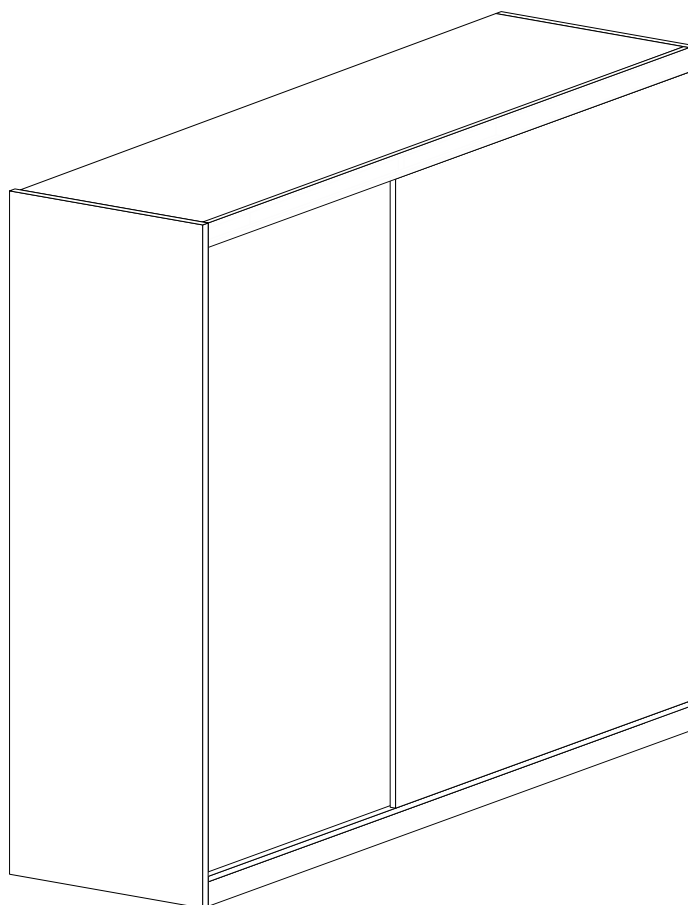

**A - 4 St.**

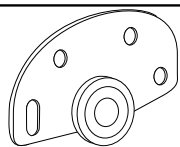

**B - 4 St.**

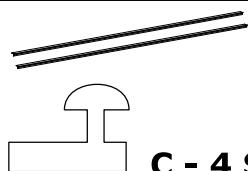

**C - 4 St.**

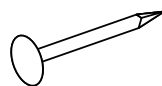

**D - 100 St.**

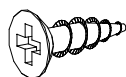

**E - 16 St.**  
2,5x10 mm



**F - 28 St.**  
3,5x16 mm



**G - 4 St.**  
3,5x16 mm

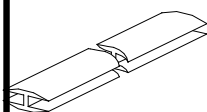

**H - 1 St.**



**I - 24 St.**



**J - 21 St.**

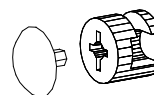

**K - 3 St.**

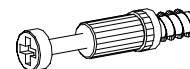

**L - 3 St.**

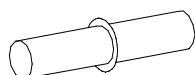

**M - 24 St.**

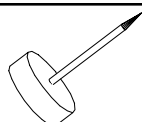

**N - 8 St.**

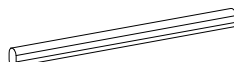

**O - 1 St.**

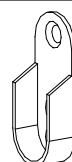

**P - 2 St.**



**R - 4 St.**

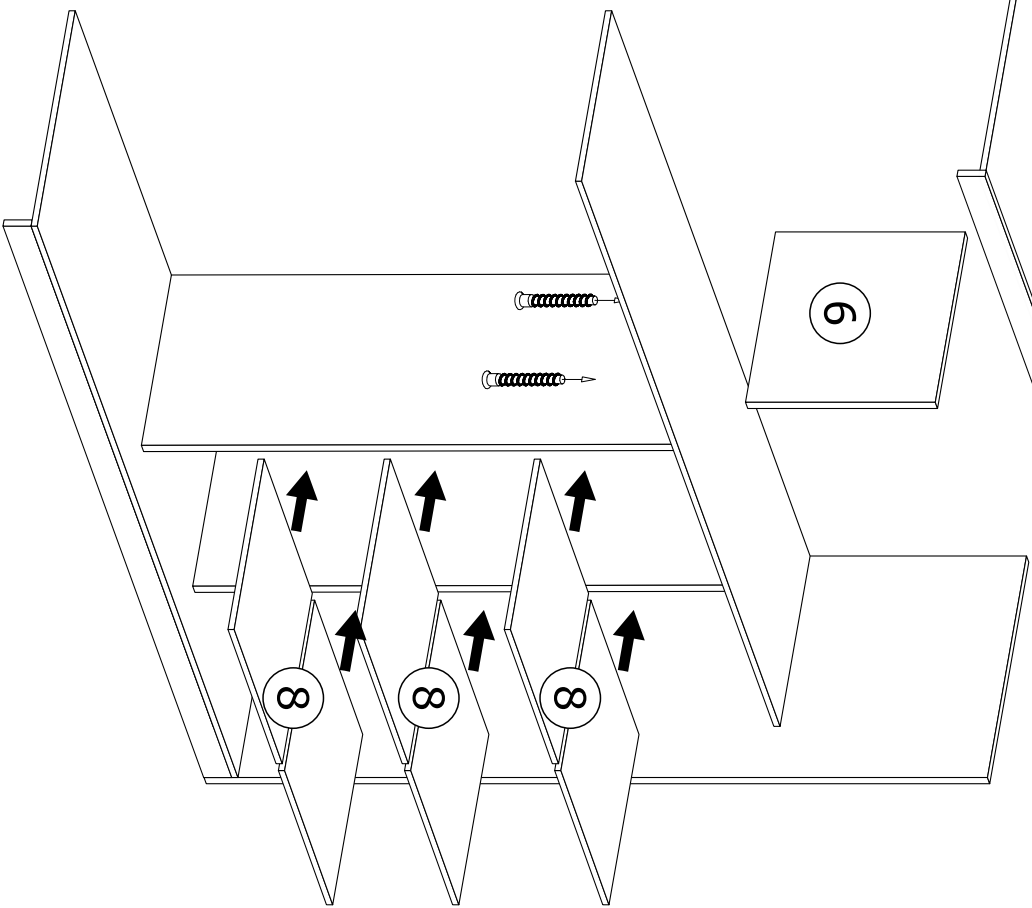
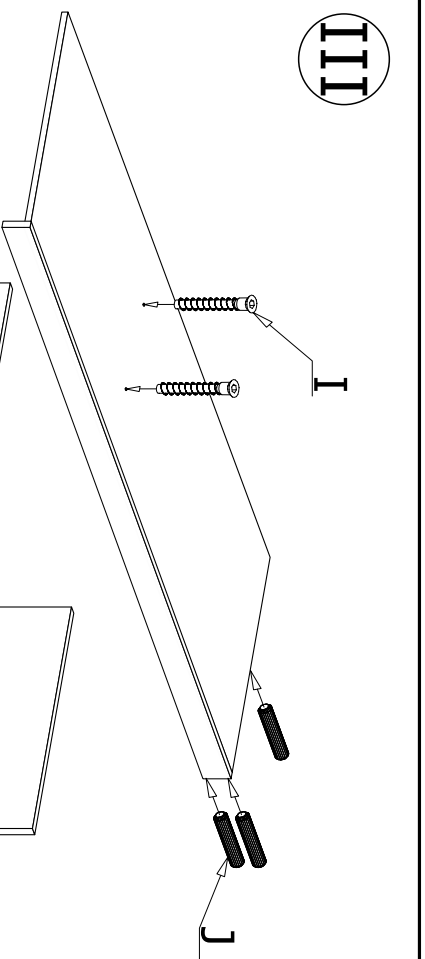
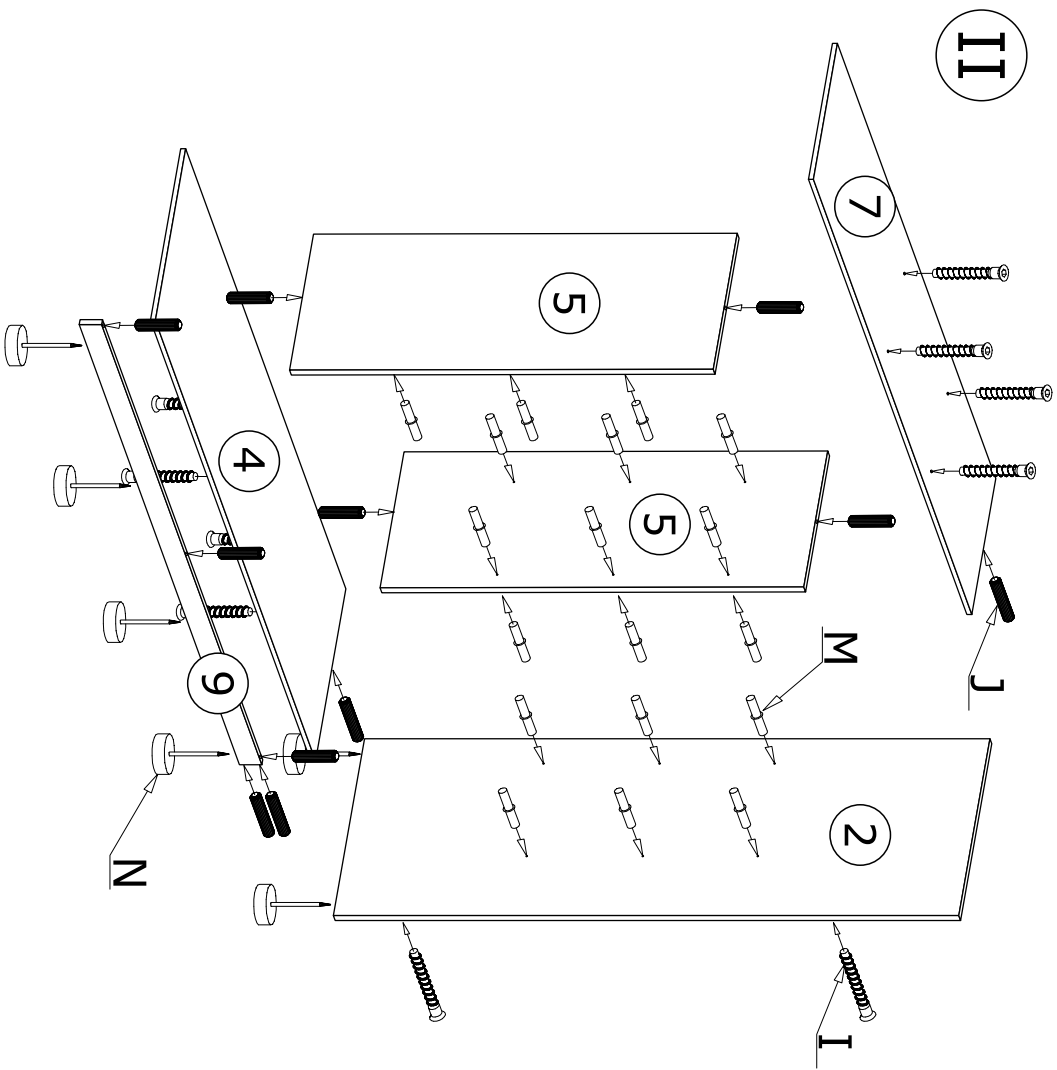
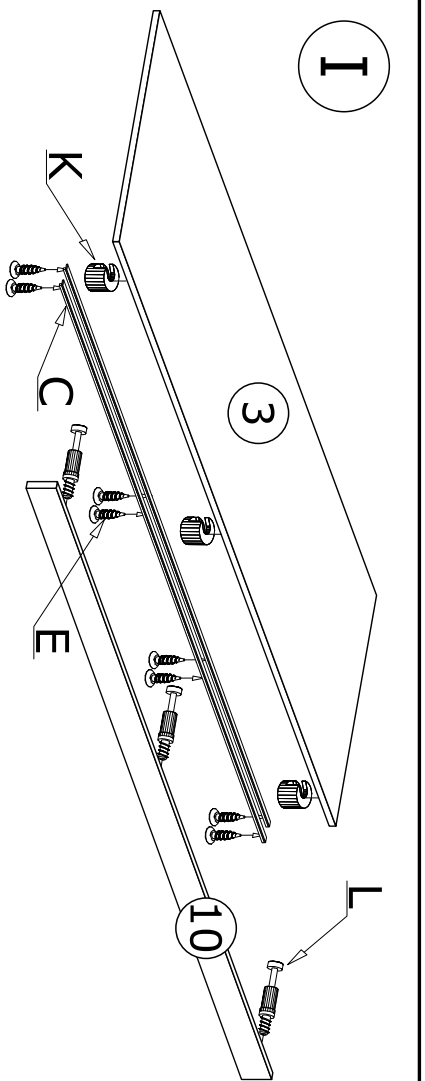

IV

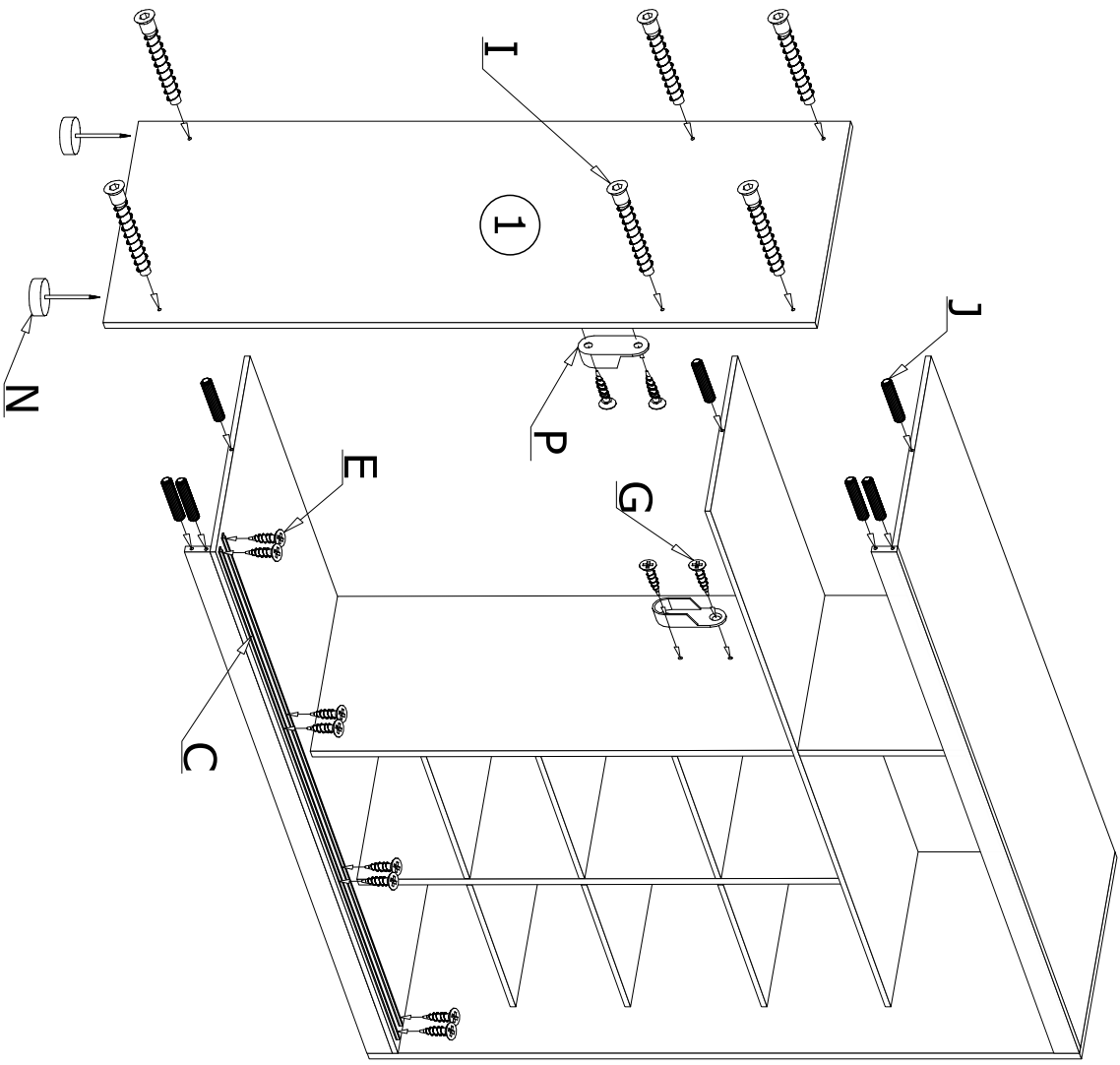

V

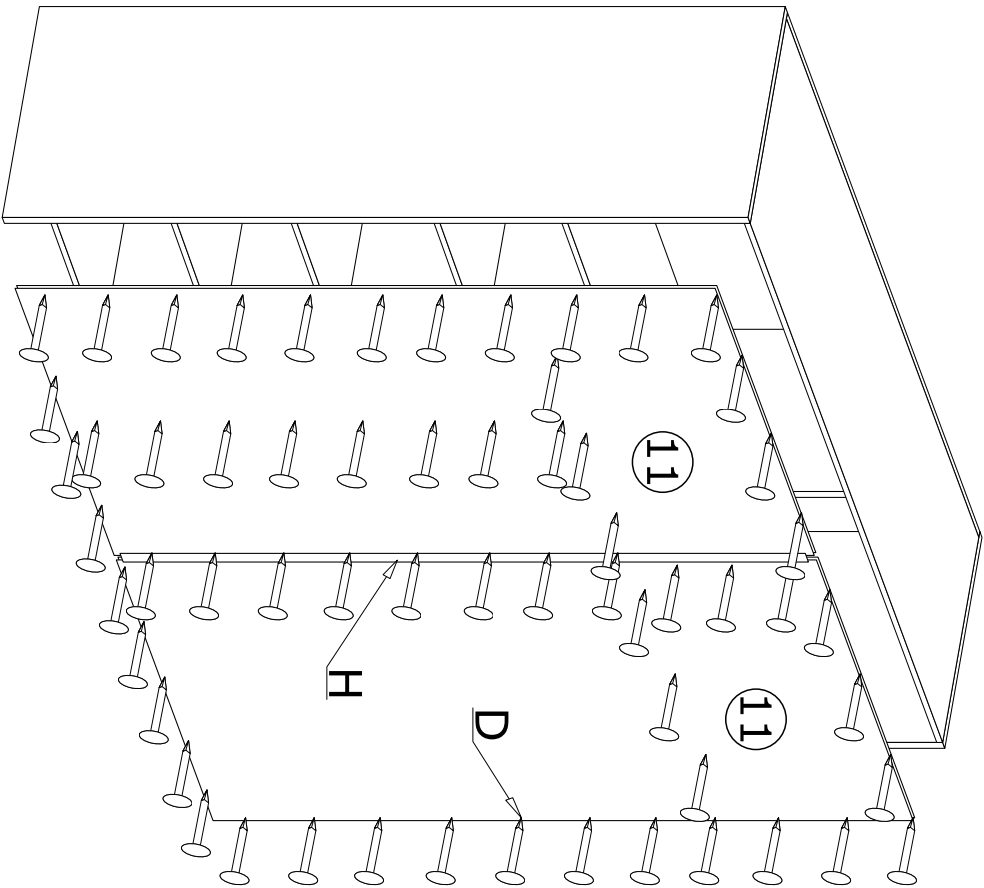

VI

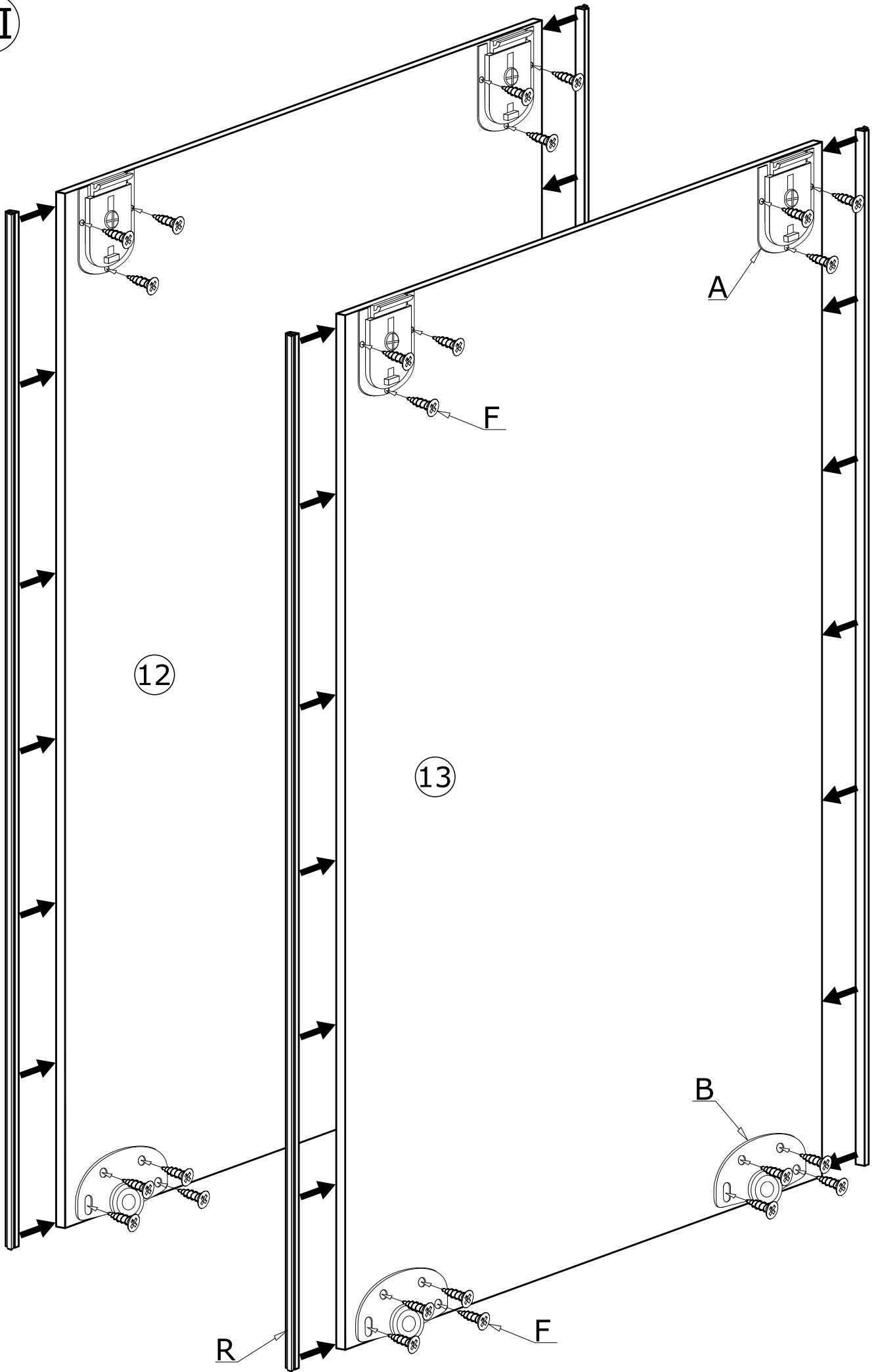

VII

