

KARMELO

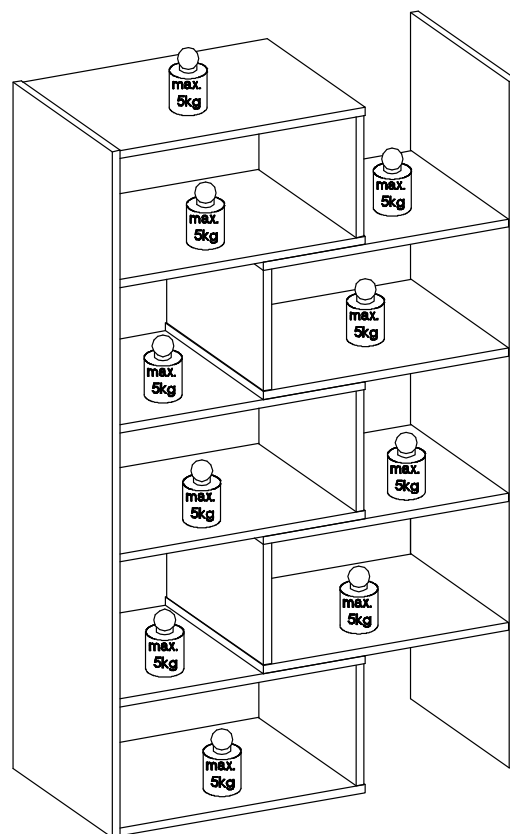
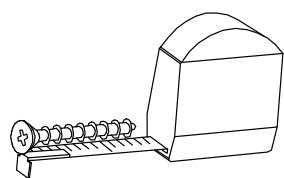
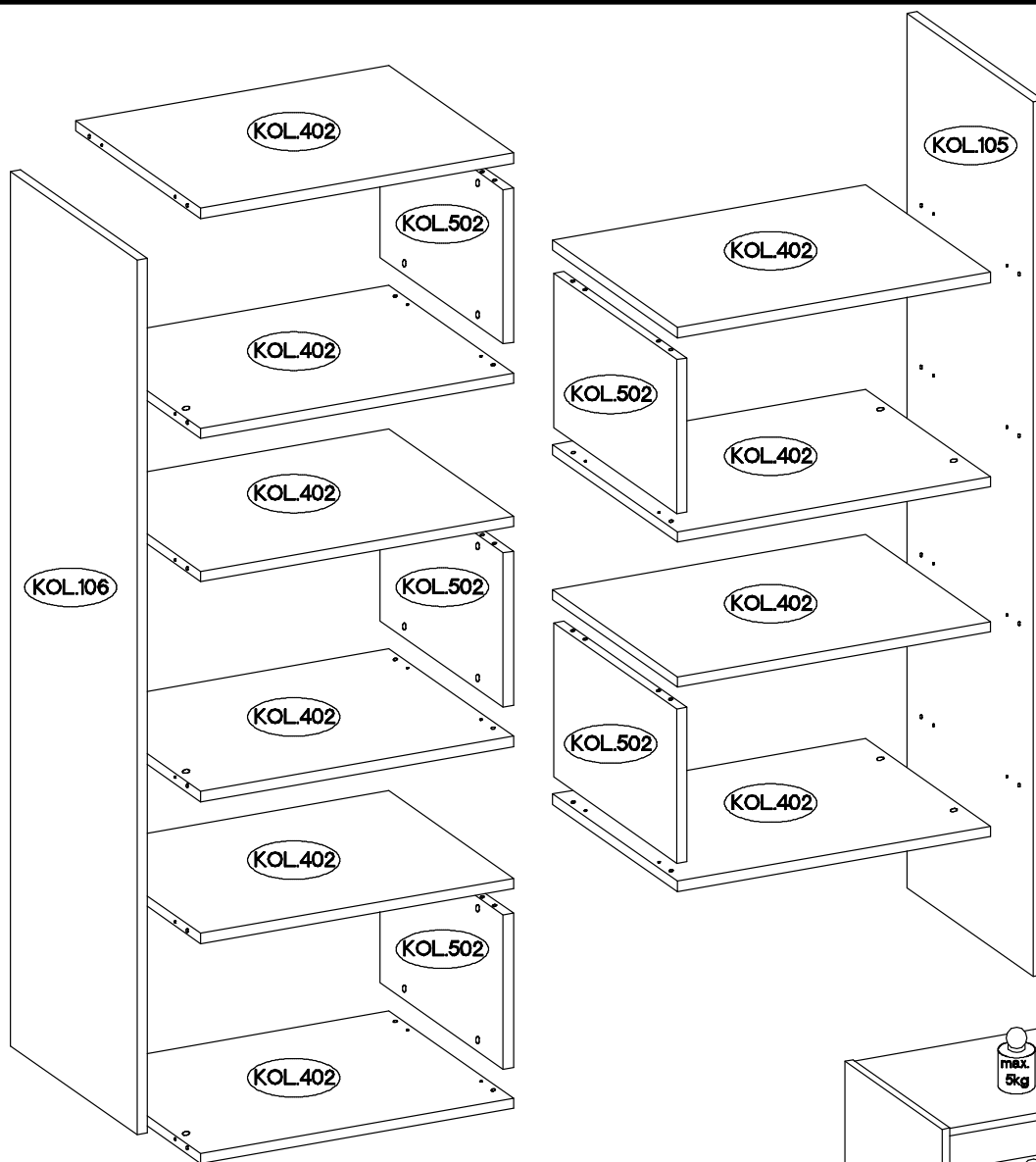
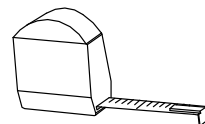
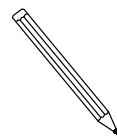
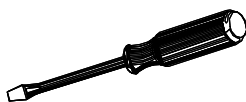
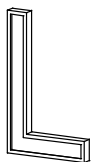
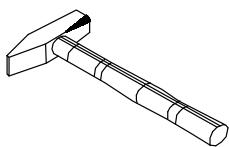
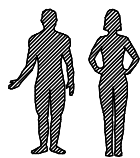

| | | | | | |
|--------------------------------------|--------------------------------------|--------------------------------------|-------------------------------------|--------------------|------------------------------------|
| 18x30mm A 40 | L=20mm D2 40 | 15/12mm C 40 | 15x5mm F4 6 | E 40 | 0,05 O11 1 |
|--------------------------------------|--------------------------------------|--------------------------------------|-------------------------------------|--------------------|------------------------------------|

1.

| | |
|---|-------------------|
| $\varnothing 8 \times 30 \text{ mm}$ A | L=20mm D2 |
| 40 $\varnothing 15/12 \text{ mm}$ C | 40 0,05 O11 |
| 40 | 1 |

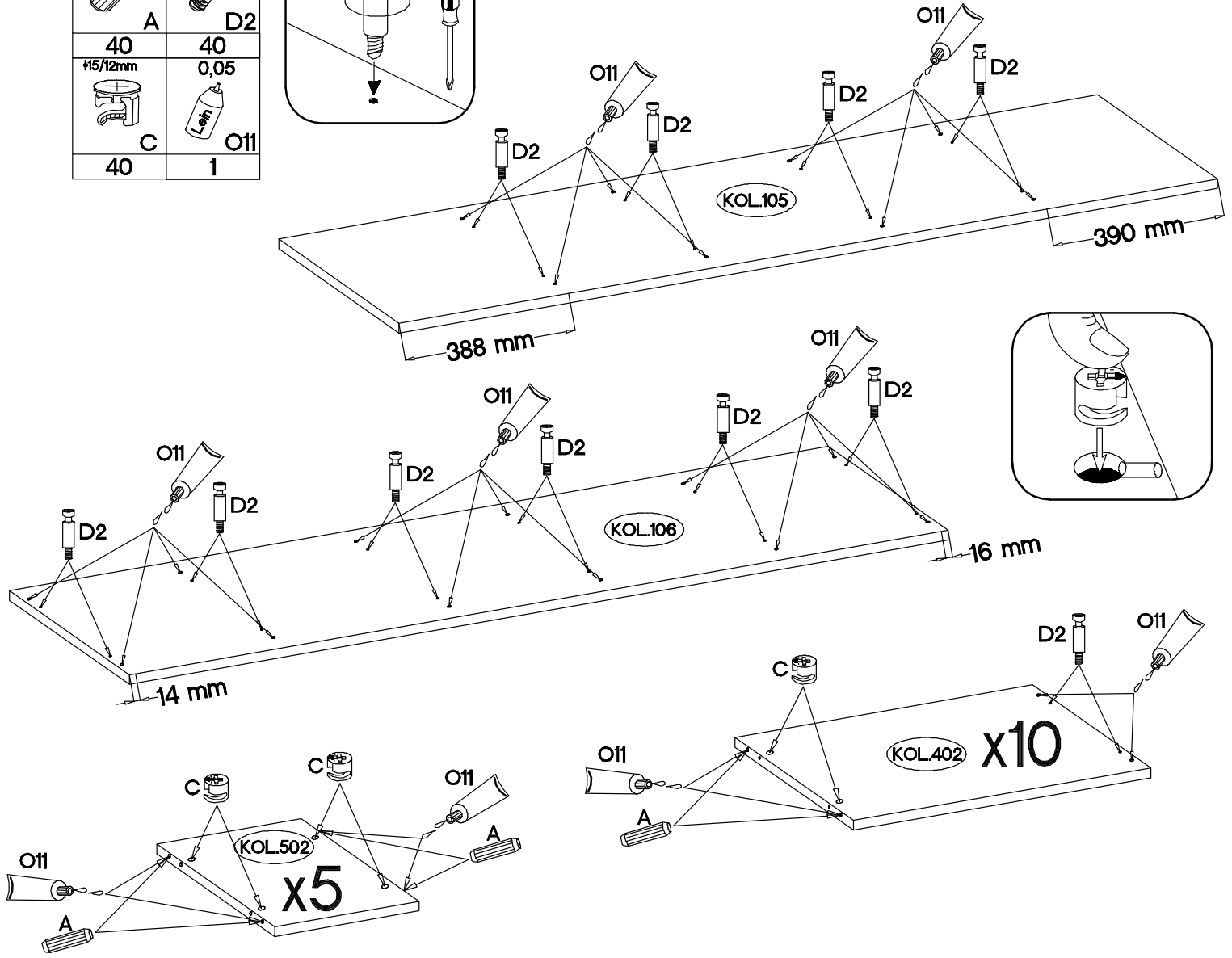
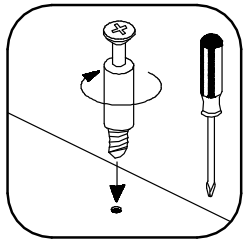

2.

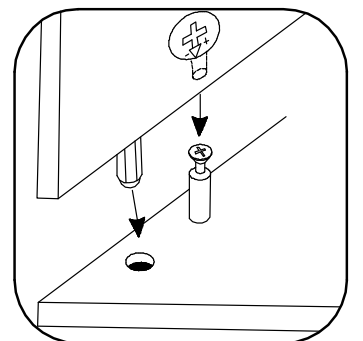
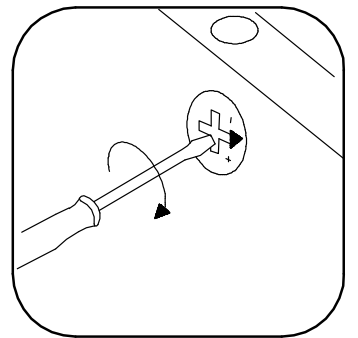
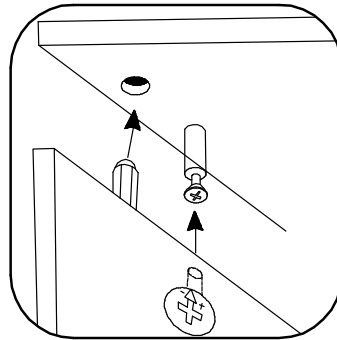
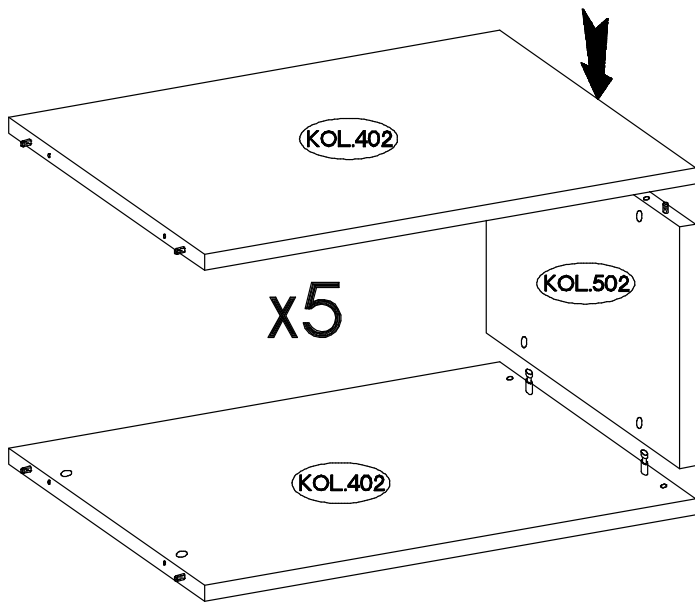

3.

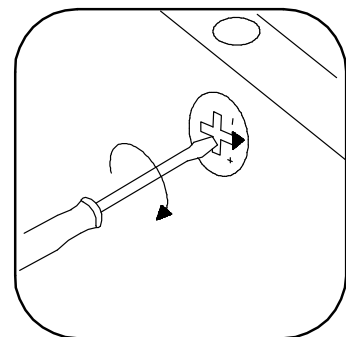
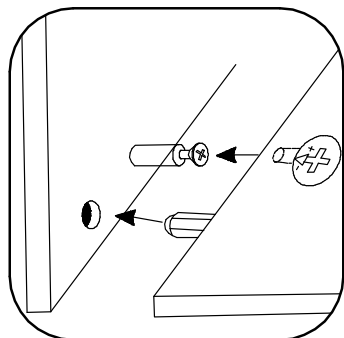
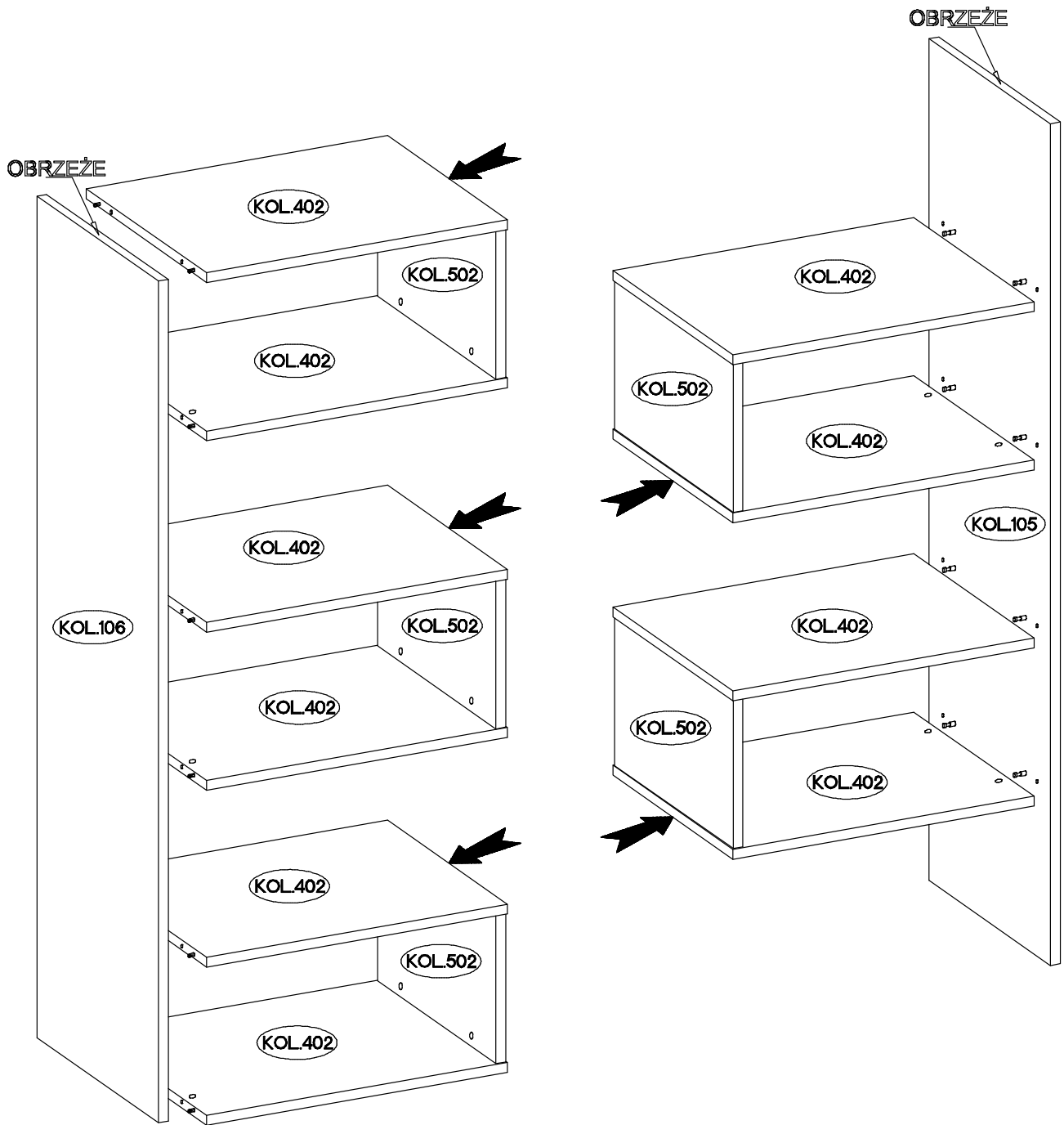

4.

| | |
|---------|--|
| ∅15x5mm |  |
| F4 | E |
| 6 | 20 |

