

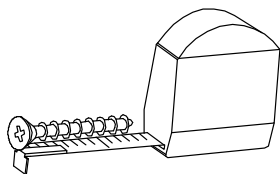

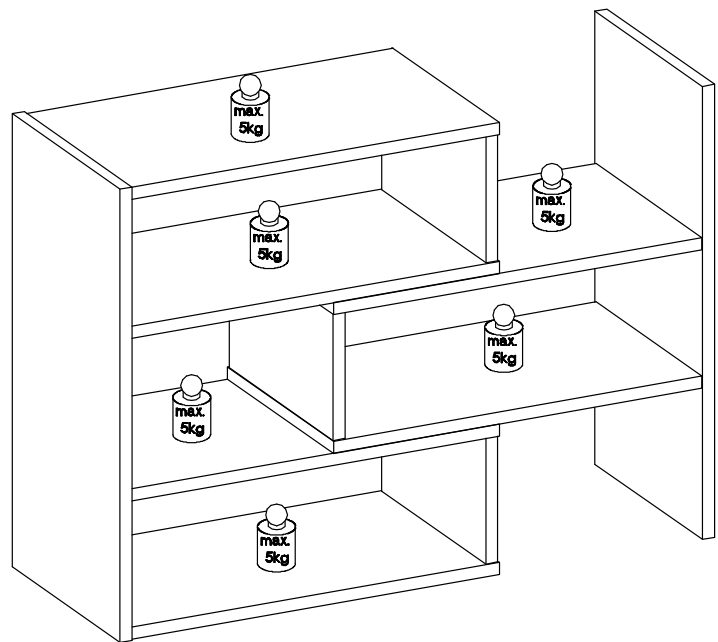

KARI

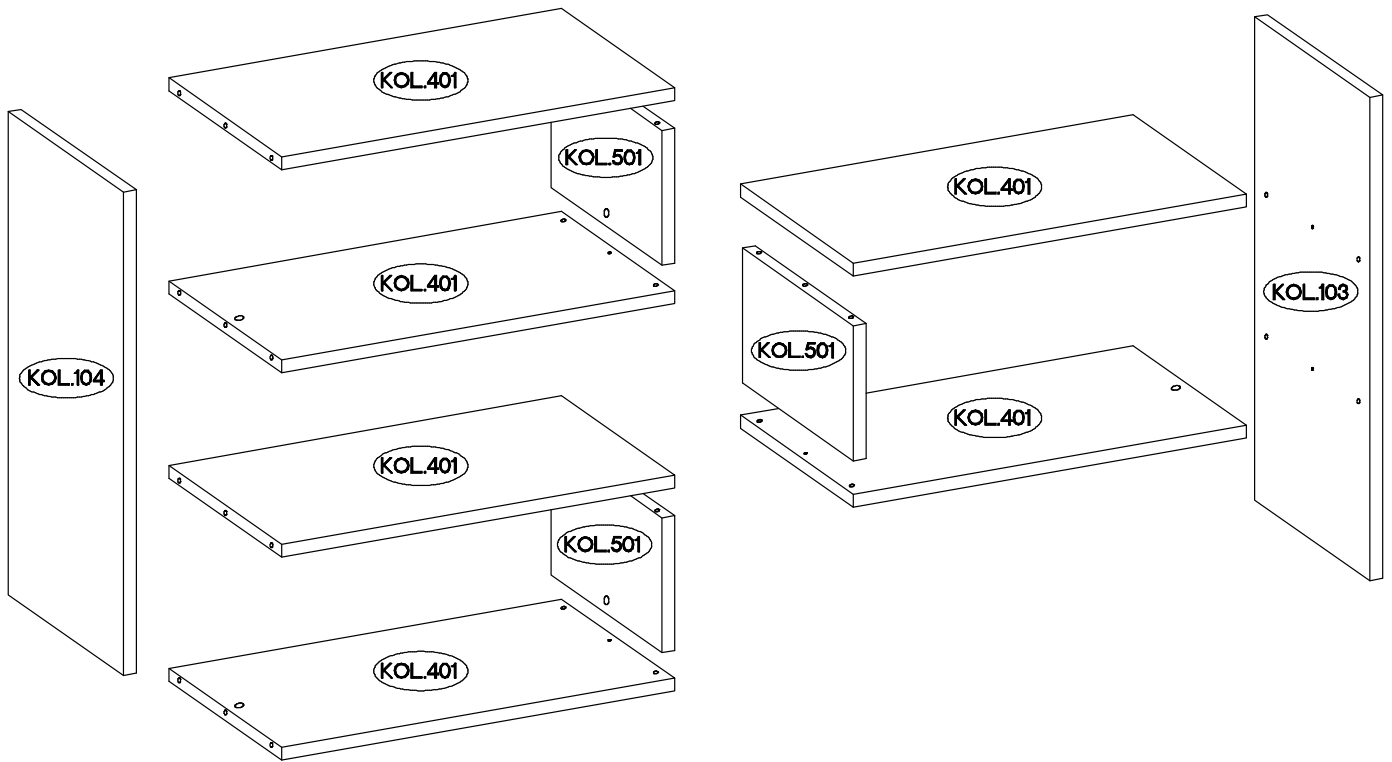
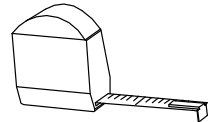
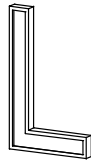
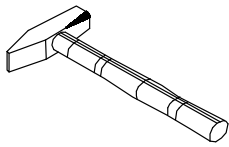
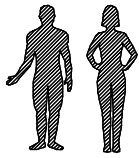

$\varnothing 8 \times 30 \text{mm}$ A 24	$L=20 \text{mm}$ D2 12	$\varnothing 15 / 12 \text{mm}$ C 12	$\varnothing 15 \times 5 \text{mm}$ F4 6	 E 12	0,05 O11 1
---	---	---	---	--------------------	-----------------------------

1.

 #8x30mm A	 L=20mm D2	 #15/12mm C	 0,05 O11
24	12	12	1

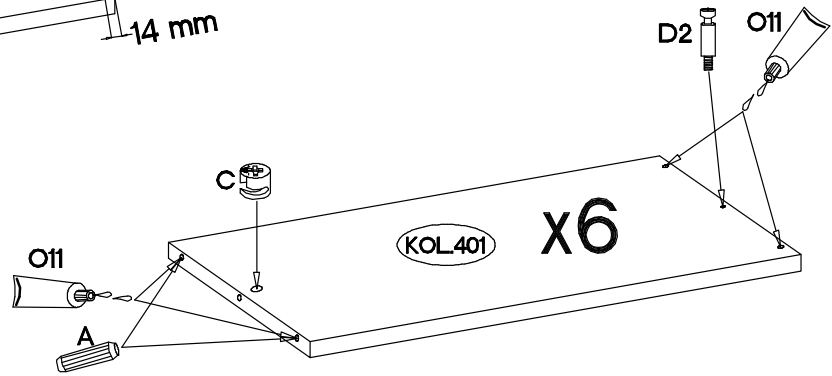
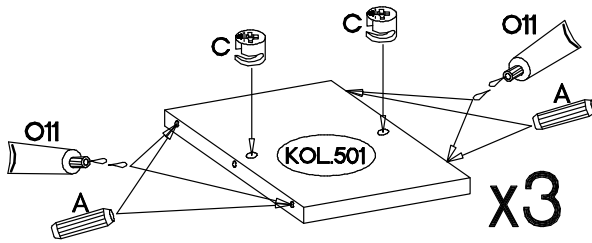
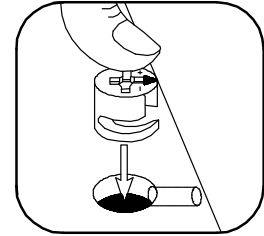
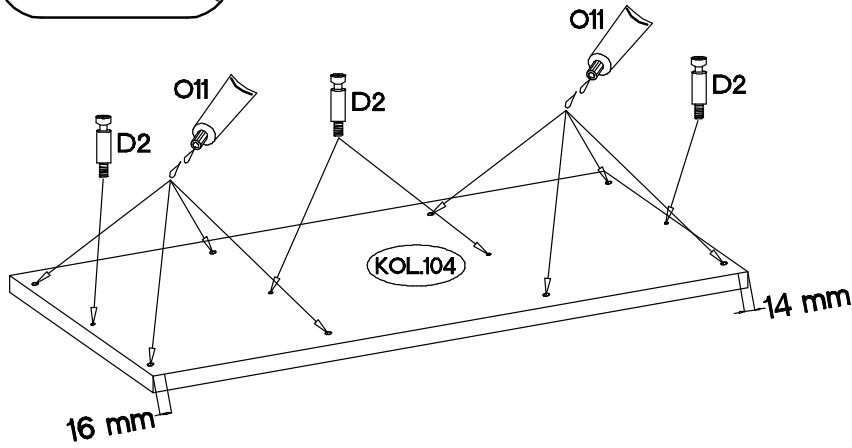
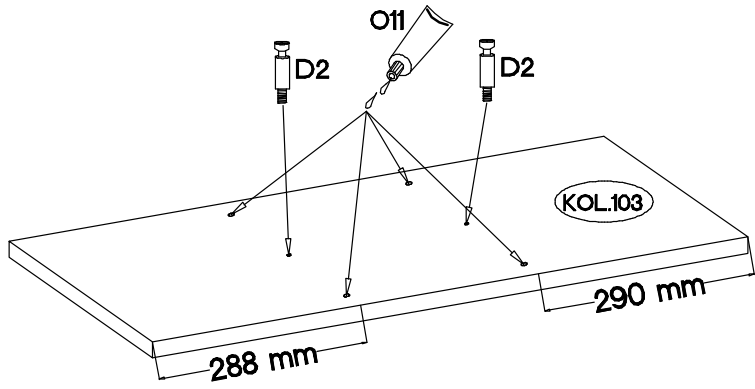
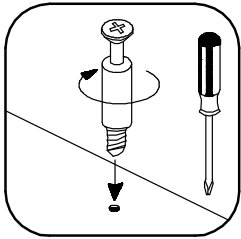

2.

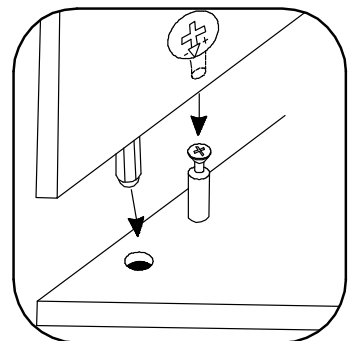
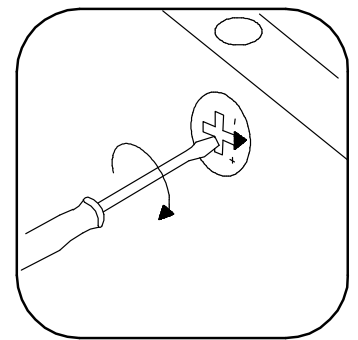
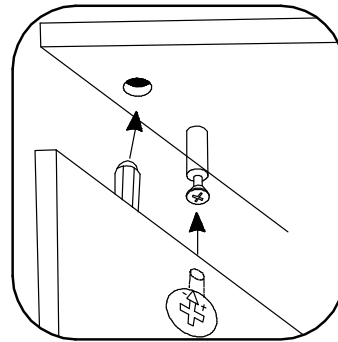
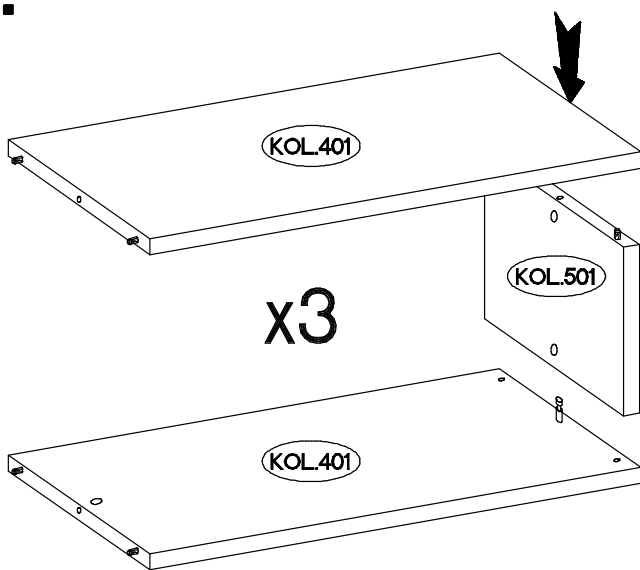

3.

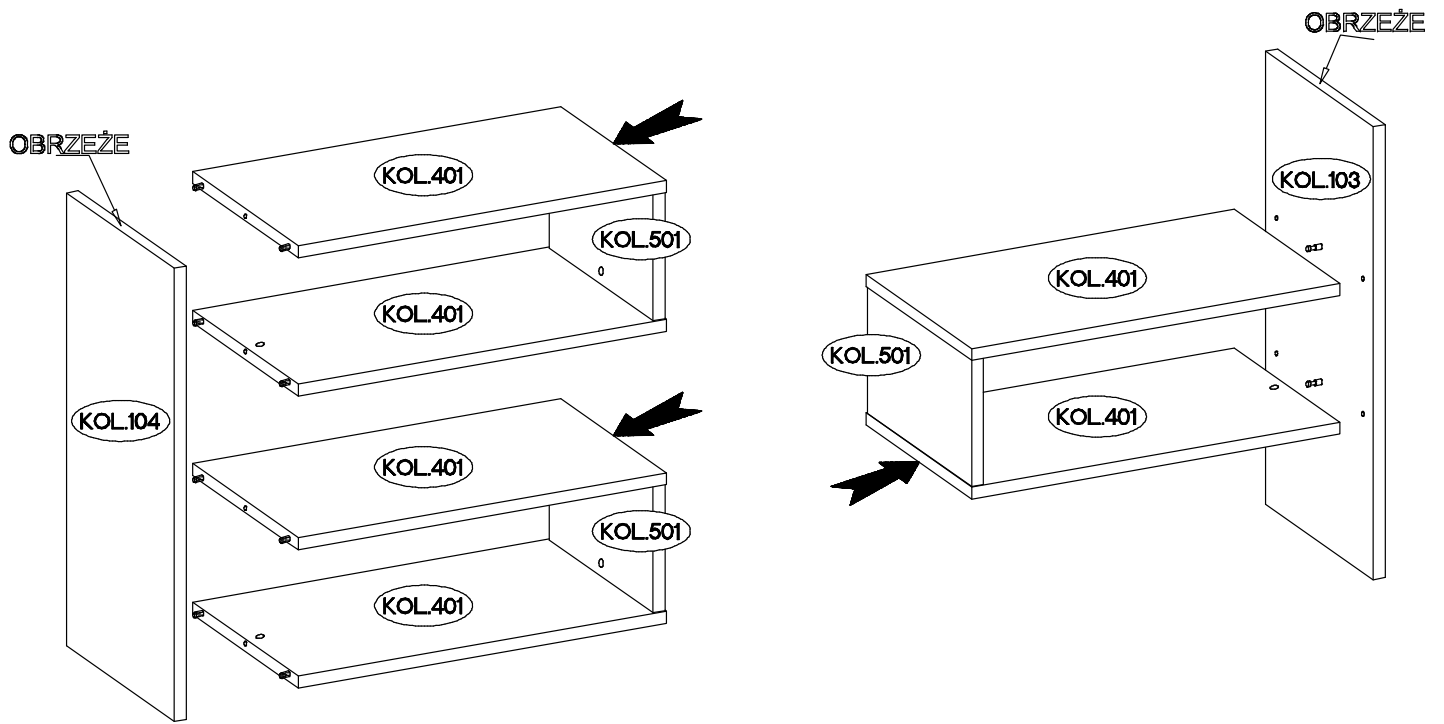

4.

