

60 min

TYP 101

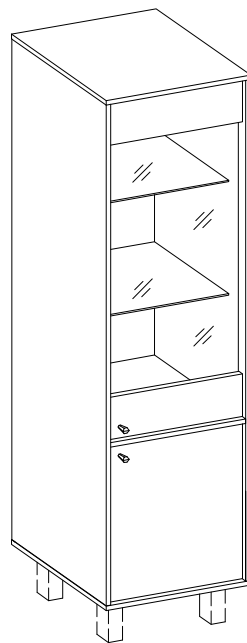
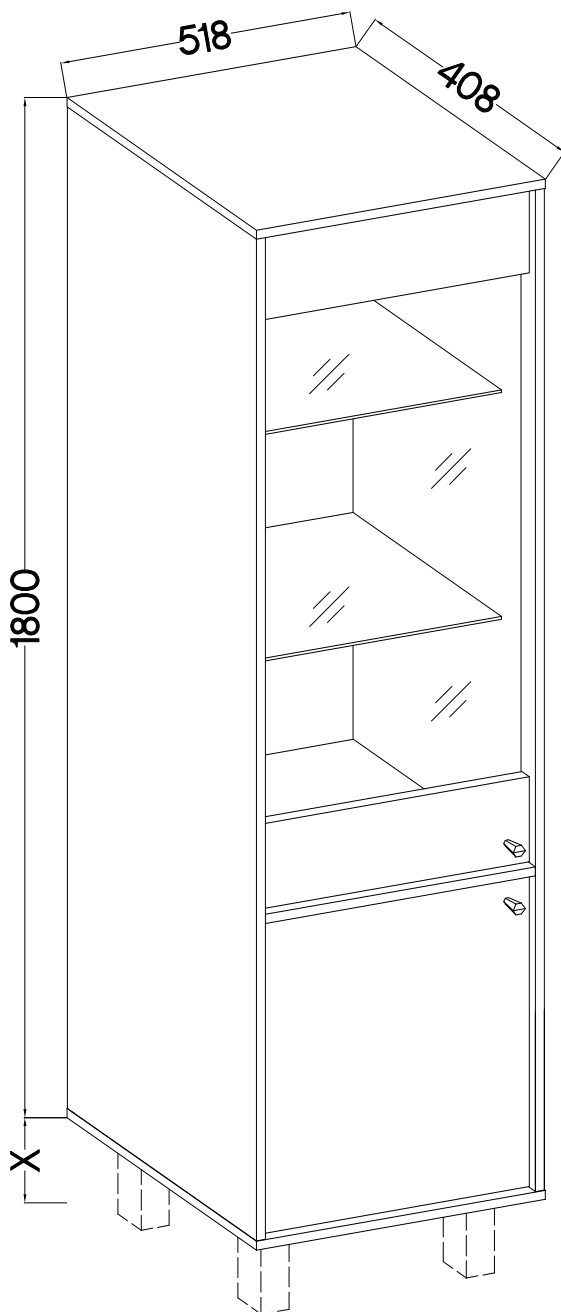
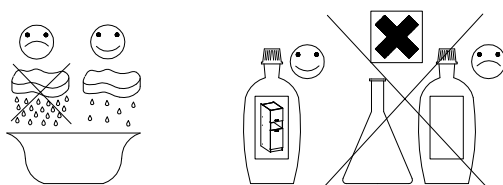

<p>†8x30mm A</p>	<p>†15/12mm C</p>	<p>L=20mm D2</p>
12	12	12
<p>J7</p>	<p>J12</p>	<p>L</p>
6	10	16

<p>75x30x15mm L19</p>	<p>†10x50mm O7</p>	<p>†3.5x13mm P5</p>	<p>†5.0x60mm P12</p>	<p>†3.0x20mm P7</p>	<p>†4.0x16mm R11</p>	<p>M4x22mm S</p>	<p>U</p>
1	1	10	1	4	6	2	2

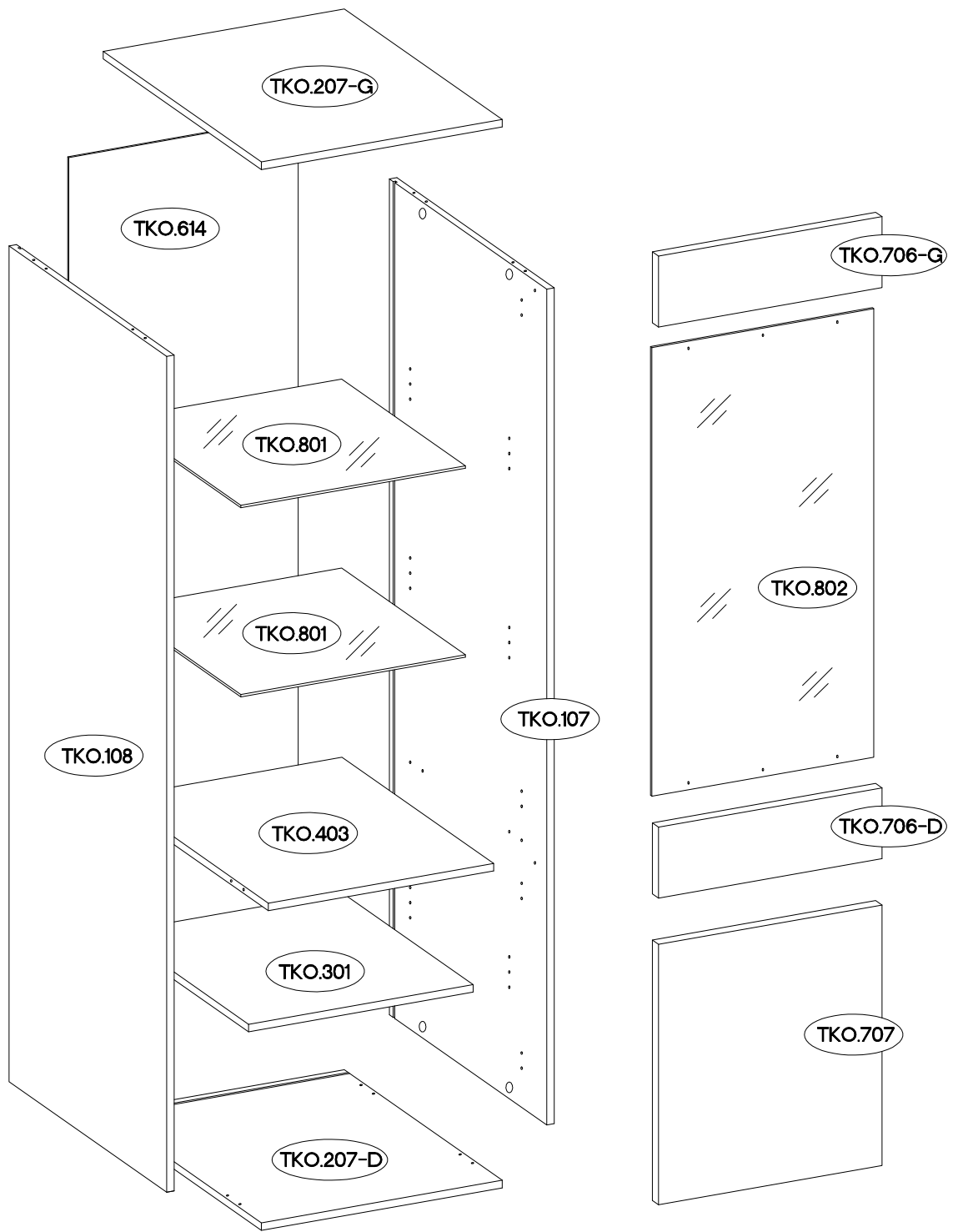

ISM-TKO-006

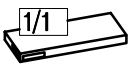

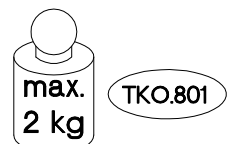
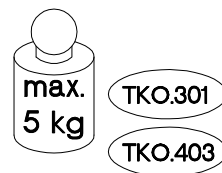
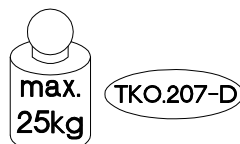
	Ersatzteil Nummer	Dimension
	TKO.107	1768x407x16
	TKO.108	1768x407x16
	TKO.207 x2	518x408x16
	TKO.403	484x392x16
	TKO.301	383x340x16
	TKO.614	1777x493x2,5
	TKO.801 x2	483x320x5
	TKO.802	949x477x4
	TKO.706 x2	150x480x16
	TKO.707	551x480x16



1

±8x30mm  A 12	±15/12mm  C 12	L=20mm  D2 8
--	---	---

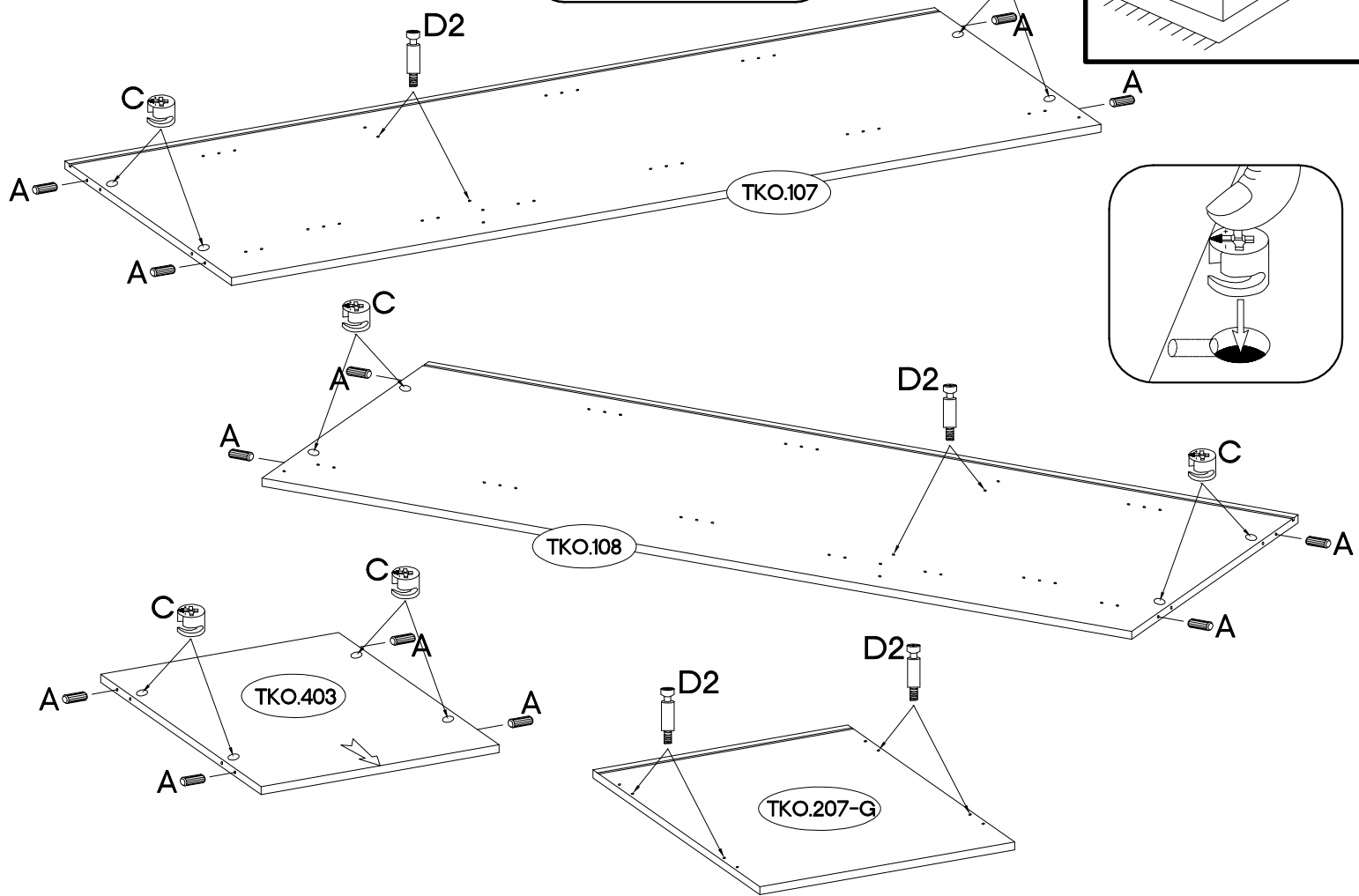
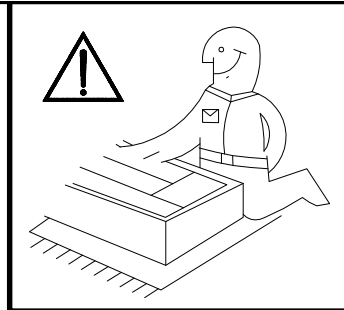
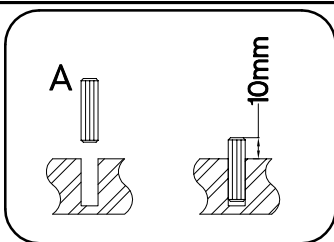

2

L=20mm  D2 4
--

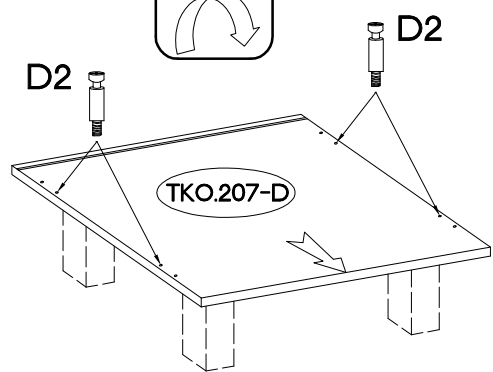
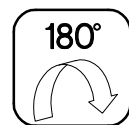
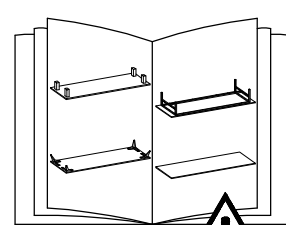
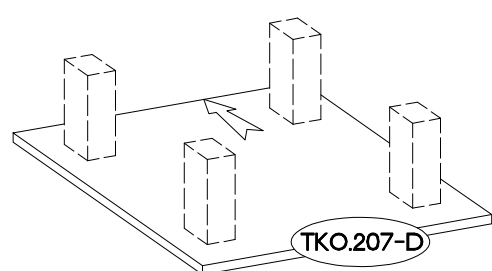
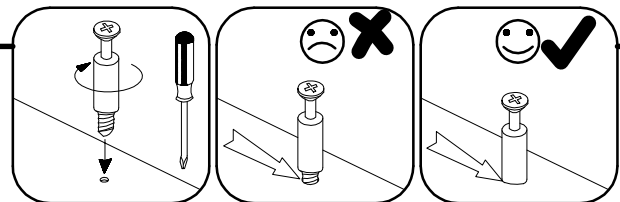

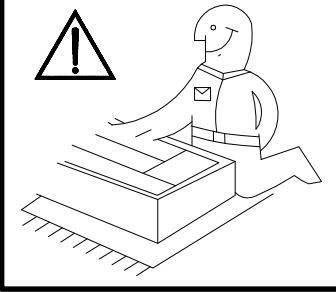
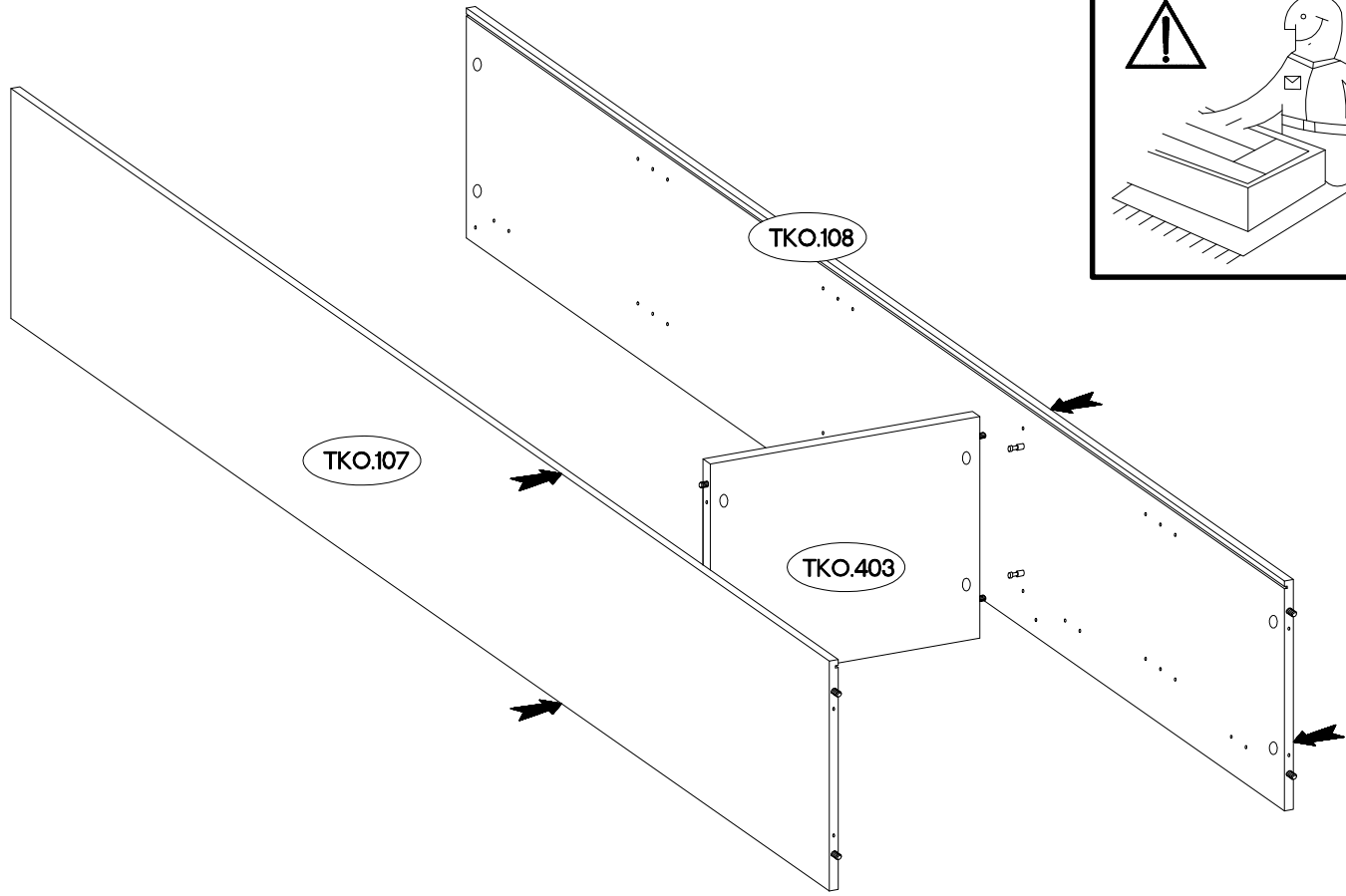

3



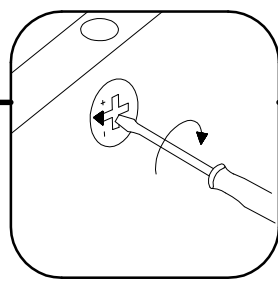
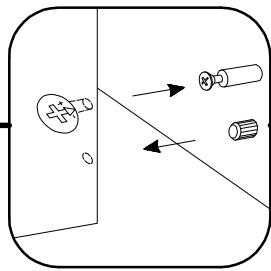
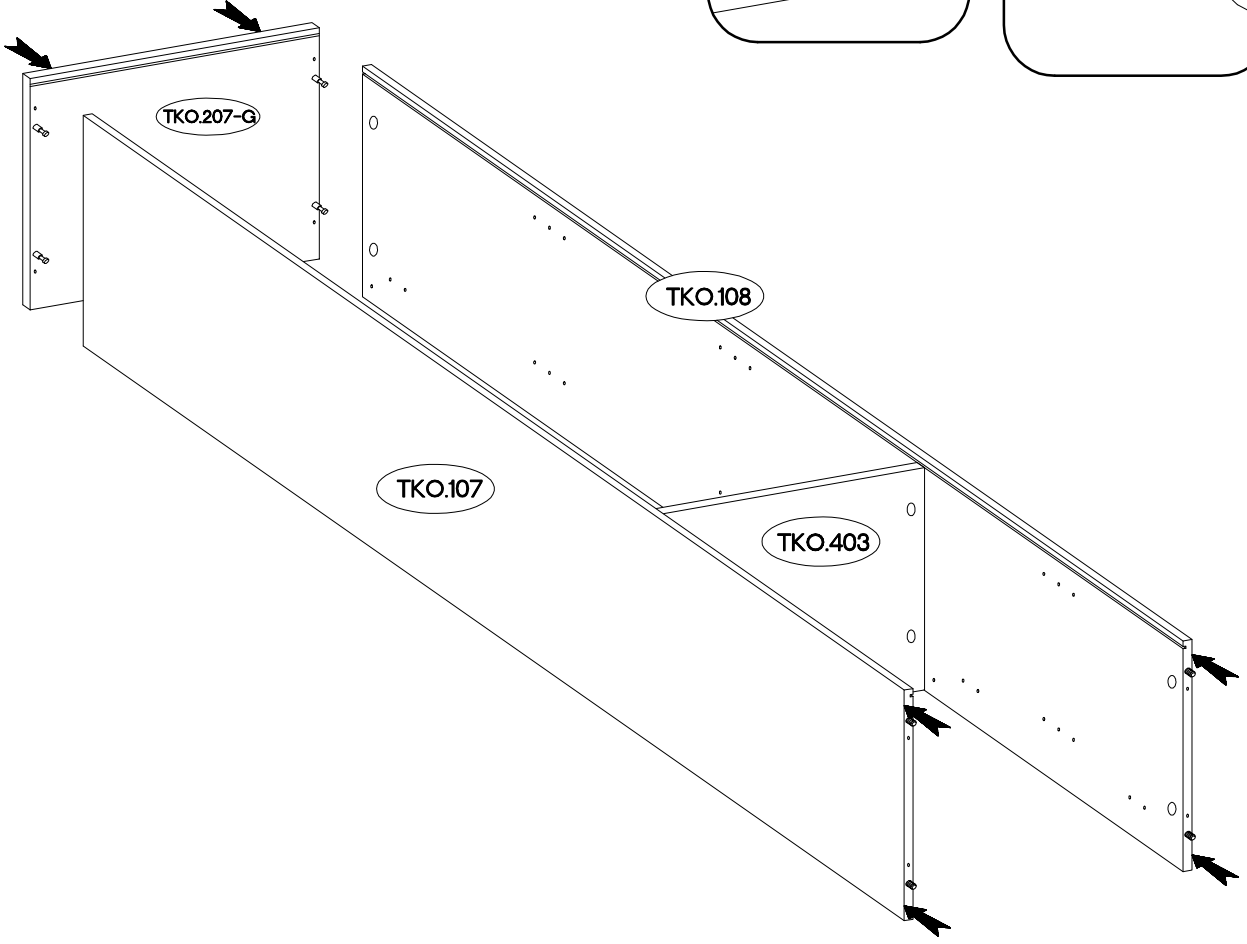



4



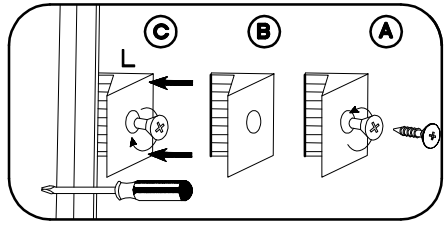
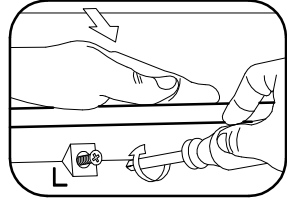
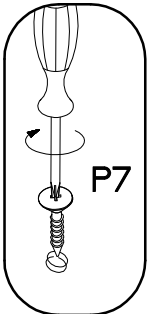
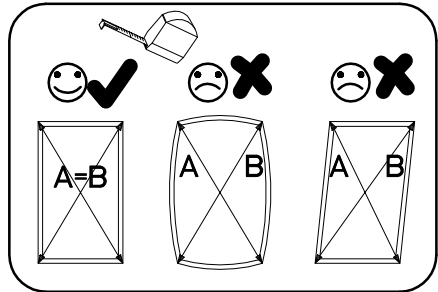
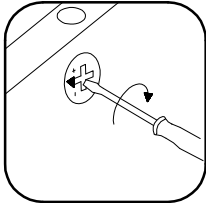
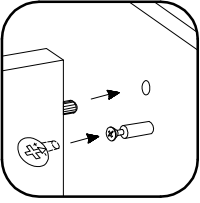
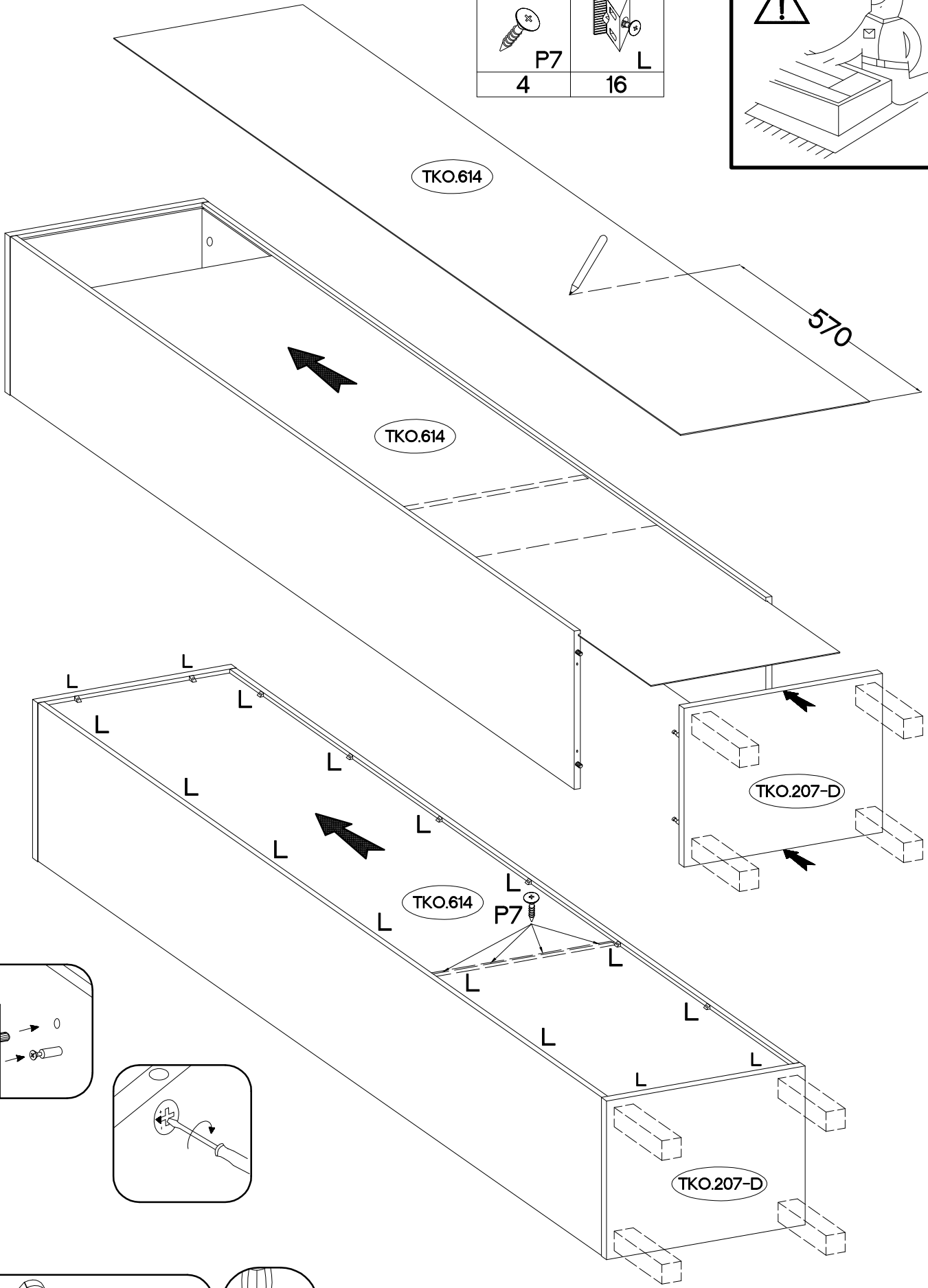
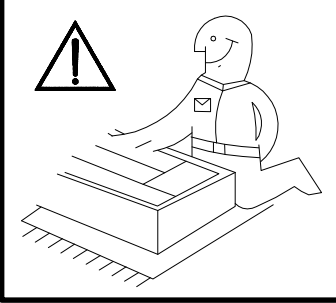

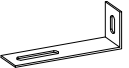

5

 P7 4	 L 16
---	---

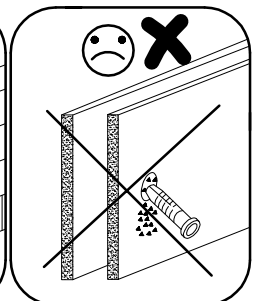
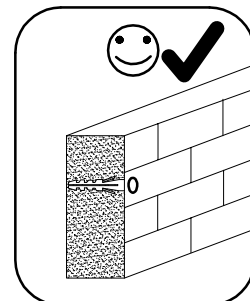
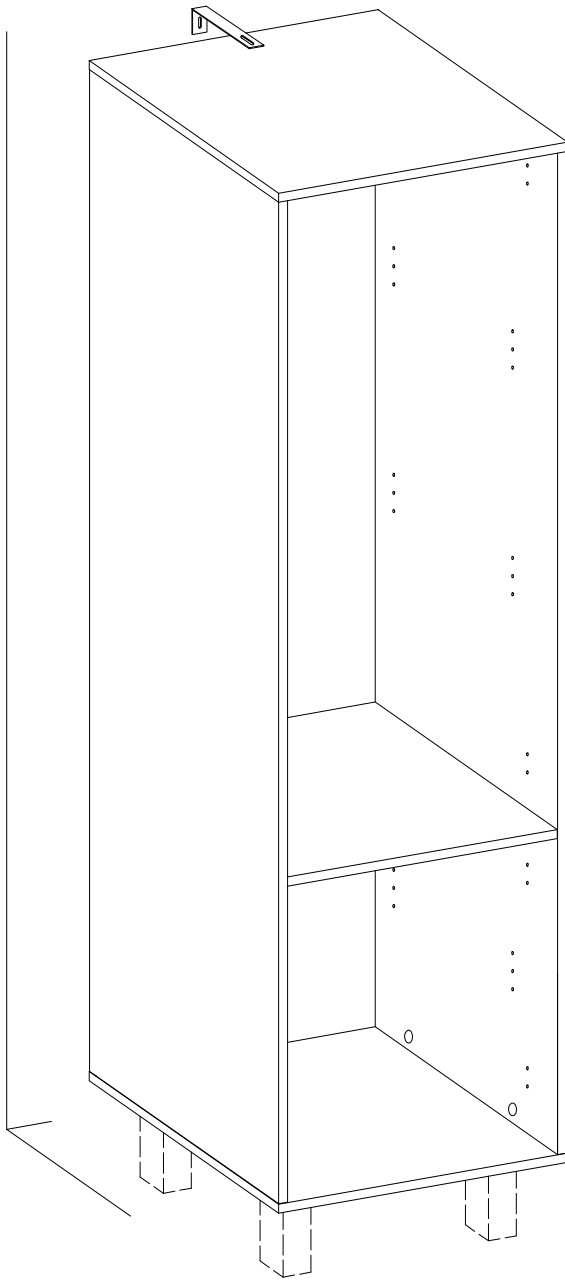
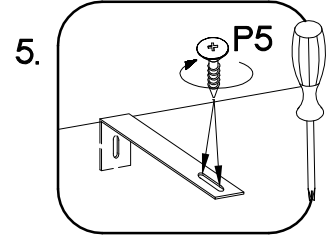
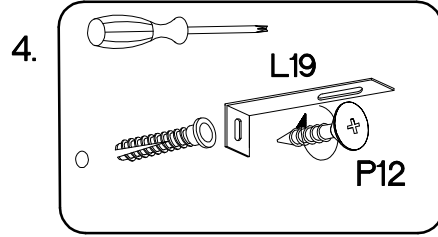
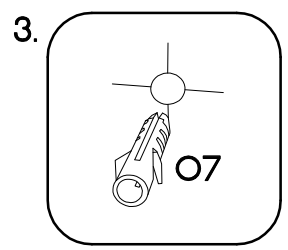
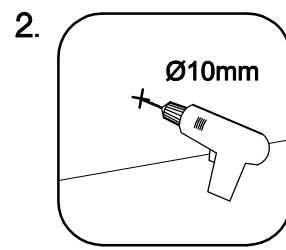
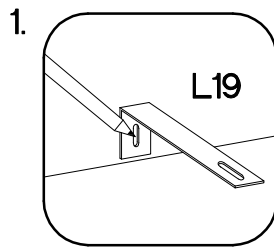

75x30x15mm	±3.5x13mm	±5.0x60mm	±10x50mm
			
L19	P5	P12	O7
1	2	1	1



$\pm 5/16\text{mm}$  J3 4	 J12 8	$\pm 20$  E11 12
---	---	--

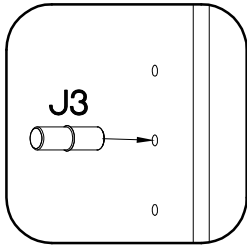
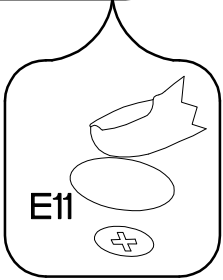
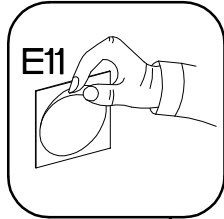
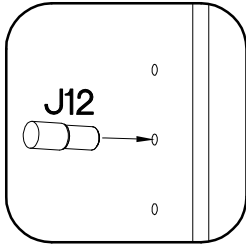
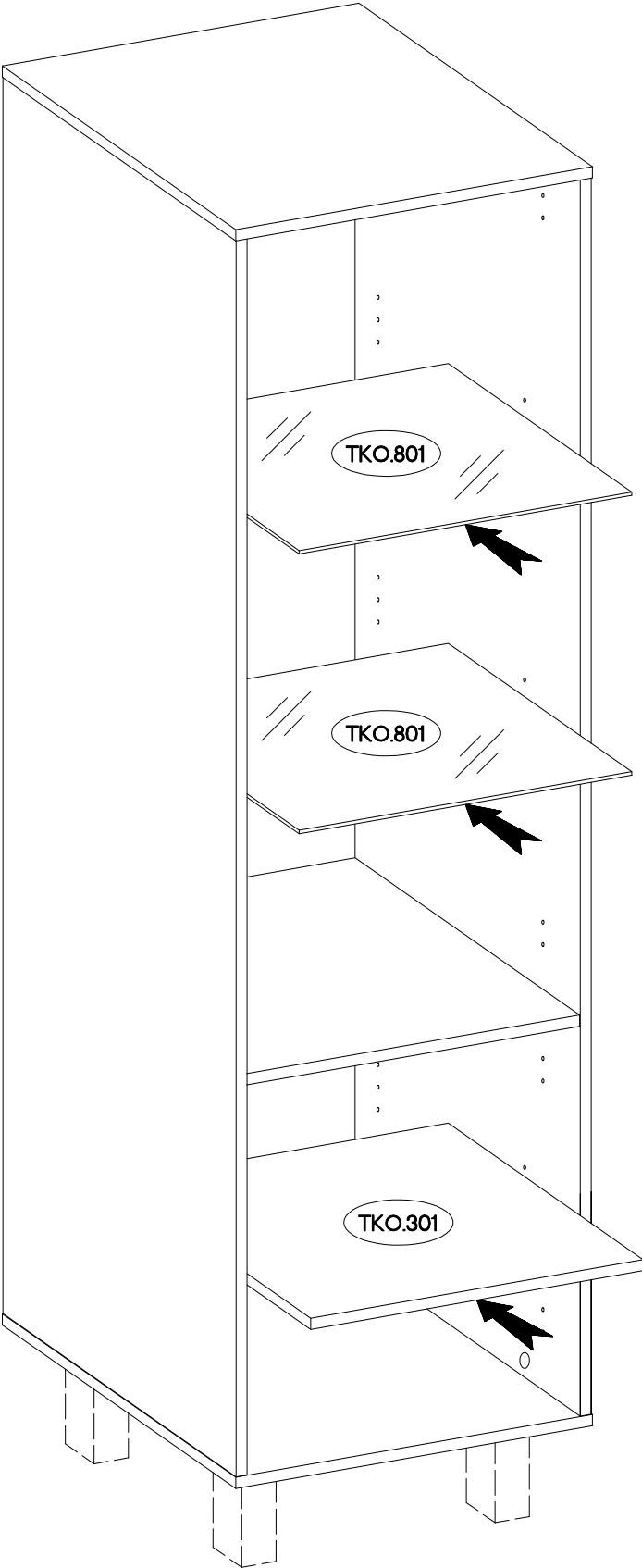

8

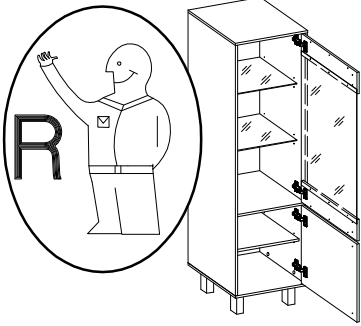

$\pm 35/16\text{mm}$	$\pm 3.5 \times 13\text{mm}$
HG2	P5
4	8

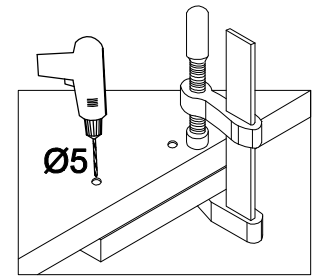
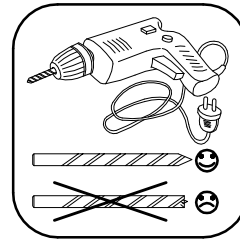
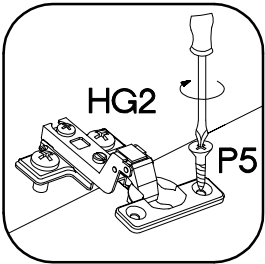
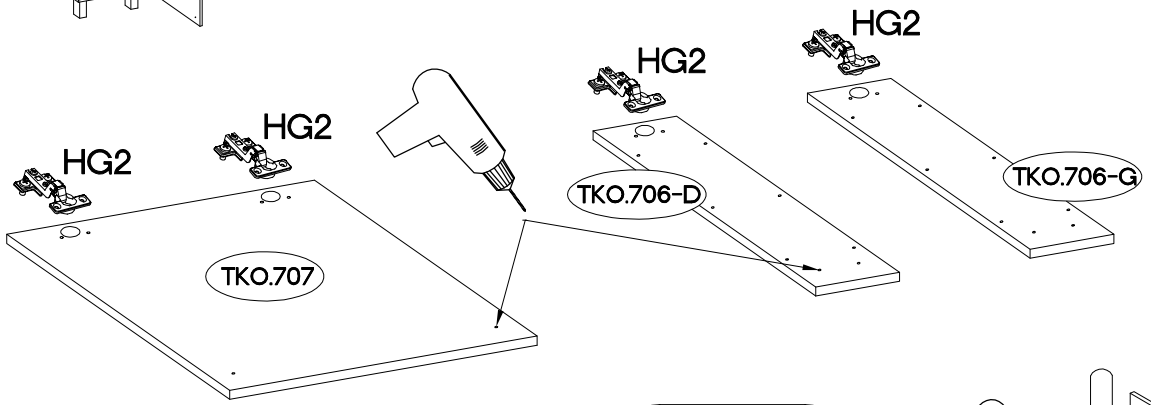

9

$\pm 4.0 \times 16\text{mm}$	$\pm 7/4\text{mm}$
R11	J7
6	6

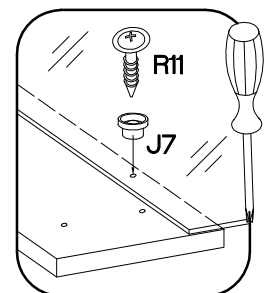
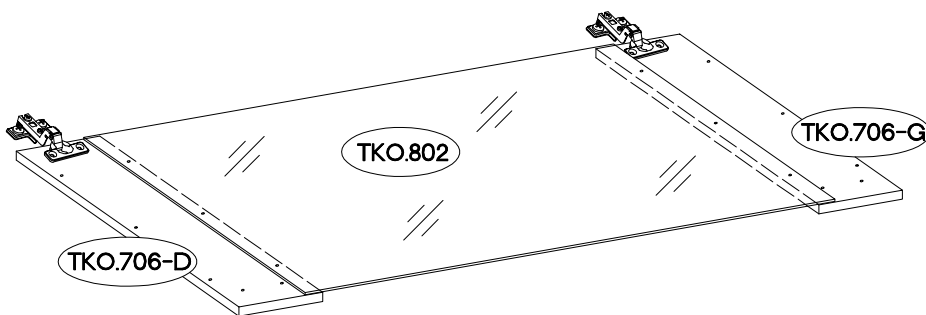
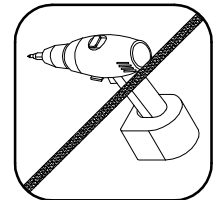
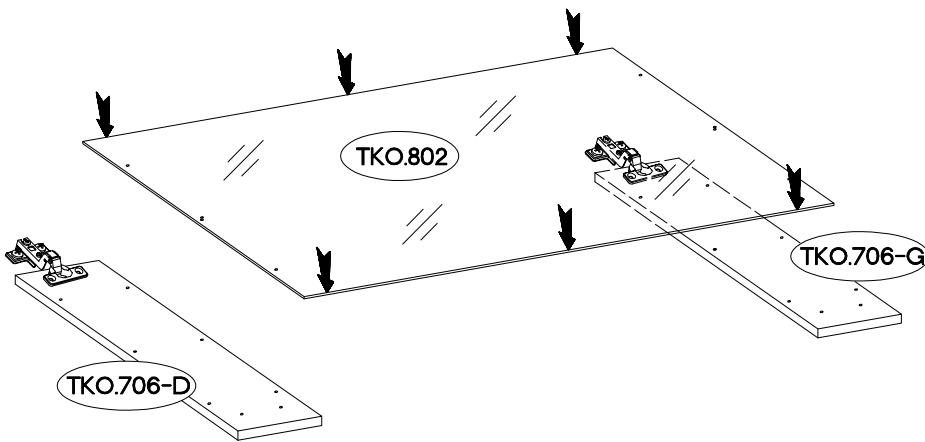



10

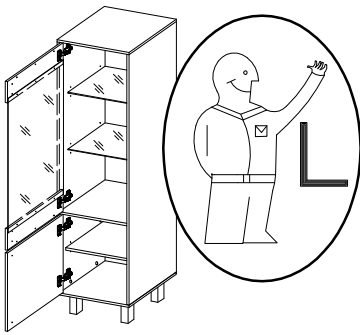



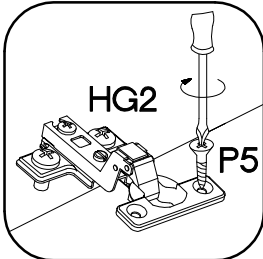
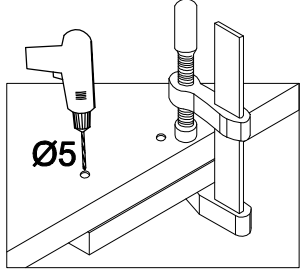
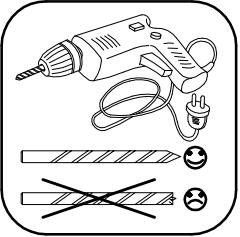
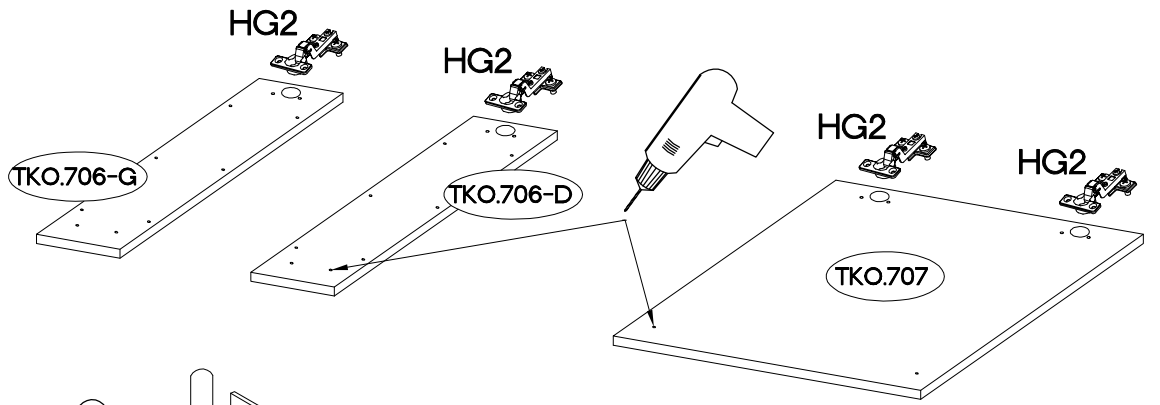

$\pm 35/16\text{mm}$	$\pm 3.5 \times 13\text{mm}$
HG2	P5
4	8

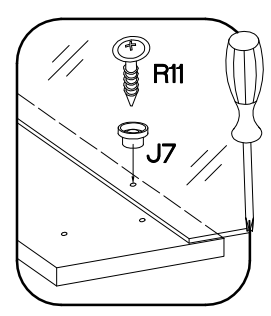
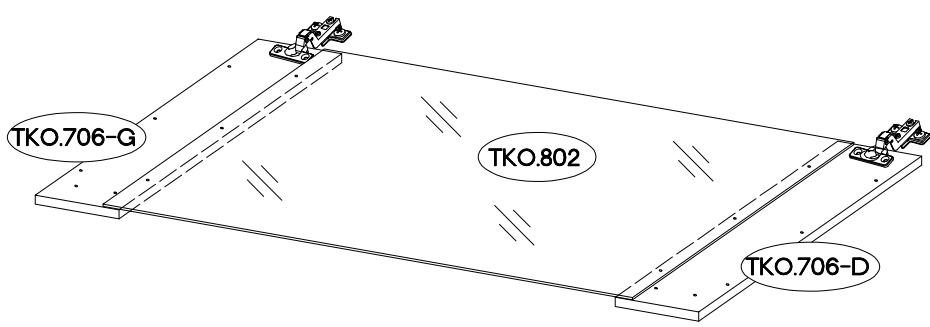
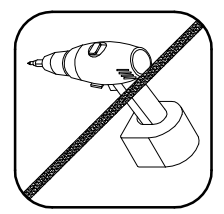
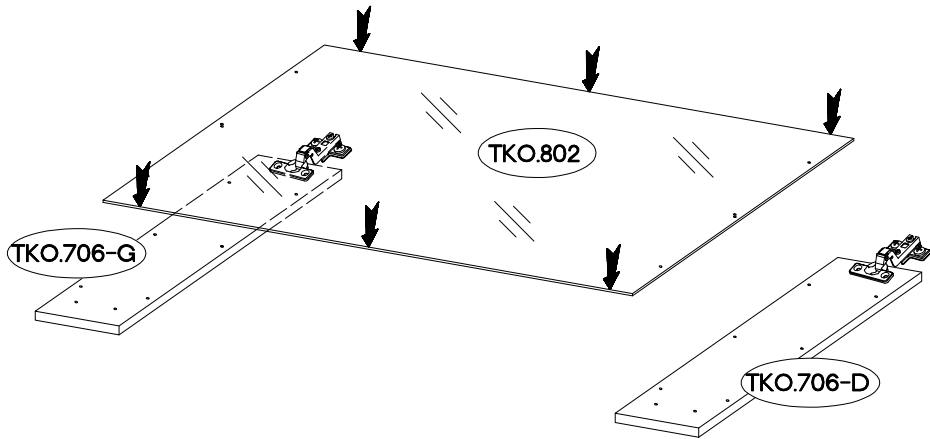

11

$\pm 4.0 \times 16\text{mm}$	$\pm 7/4\text{mm}$
R11	J7
6	6



	M4x22mm 	
S	U	J12
2	2	2

