

# ECOFLOW

PRO

## EcoFlow DELTA Pro Smart Extra Battery

—

### User Manual

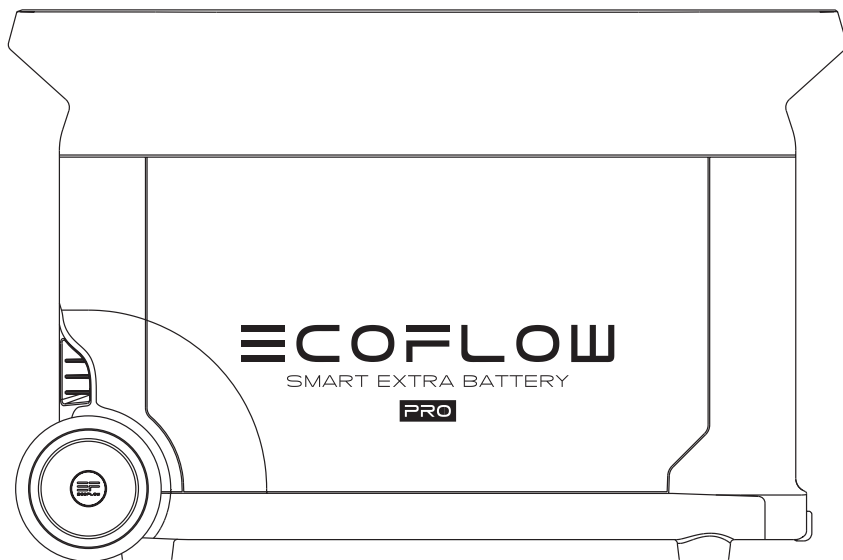

# DISCLAIMER

---

Read all safety tips, warning messages, terms of use, and disclaimers carefully. Refer to the terms of use and disclaimer at <https://ecoflow.com/pages/terms-of-use> and stickers on the product before use. Users take full responsibility for all usage and operations. Familiarize yourself with the related regulations in your area. You are solely responsible for being aware of all relevant regulations and using EcoFlow products in a way that is compliant.

# CONTENTS

<b>1. Specifications</b>	1
<b>2. Safety Instructions</b>	
2.1 Usage	2
2.2 Disposal Guide	2
<b>3. Getting Started</b>	
3.1 Product Details	3
3.2 LCD Screen	4
3.3 General Product Usage	4
<b>4. FAQs</b>	6
<b>5. Troubleshooting</b>	6
<b>6. What's In the Box</b>	7
<b>7. Storage &amp; Maintenance</b>	7
<b>8. Fcc Statement</b>	

# 1. Specifications

## General Info

Net Weight	Approximately 38kg (84lbs)
Dimensions	635 x 285x 416mm (25x11.2x16.4in)
Capacity	3600Wh 48V <sup>DC</sup>

## Input Port

Extra Battery Port Input	48V <sup>DC</sup> 3200W Max
--------------------------	-----------------------------

## Output Port

Extra Battery Port Output	45V-54V <sup>DC</sup> 4260W Max
---------------------------	---------------------------------

## Battery Info

Cell Chemistry	LFP
Cycle Life	3500 cycles to 80%+ capacity
Protection	Overload Protection, Over Temperature Protection, Short Circuit Protection, Low Temperature Protection, Low Voltage Protection, Overcurrent Protection

## Environmental Operating Temperature

Optimal Operating Temperature	20°C - 30°C (68°F - 86°F)
Discharge Temperature	-10°C - 45°C (14°F - 113°F)
Charge Temperature	0°C - 45°C (32°F - 113°F)
Storage Temperature	-10°C - 45°C (14°F - 113°F) (optimal: 20°C - 30°C (68°F - 86°F))

\* Whether the product can be charged or discharged depends on the actual temperature of the battery pack.

## 2. Safety Instructions

### 2.1 Usage

1. Do not use the product near a heat source, such as a fire source or a heating furnace.
2. Avoid contact with any liquid. Do not immerse the product in water or get it wet. Do not use the product in rain or humid environments.
3. Do not use the product in an environment with strong static electricity/magnetic fields.
4. Do not disassemble the product in any way or pierce the product with sharp objects.
5. Avoid using wires or other metal objects that may result in a short circuit.
6. Do not use unofficial components or accessories. If you need to replace any components or accessories, please visit official EcoFlow channels to check relevant information.
7. When using the product, please strictly follow the operating environment temperature specified in this user manual. If the temperature is too high, it may result in a fire or explosion; if the temperature is too low, the product performance may be severely reduced, or the product may cease to work.
8. Do not stack any heavy objects on the product.
9. Do not lock the fan forcibly during use or place the product in an unventilated or dusty area.
10. Please avoid impact, falls, or severe vibrations when using the product. In case of a severe external impact, turn off the power supply immediately and stop using the product. Ensure the product is well fastened during transportation to avoid vibrations and impacts.
11. If you accidentally drop the product into water during use, please place it in a safe open area, and stay away from it until it is completely dry. The dried product should not be used again, and should be properly disposed of according to Section 2.2 below. If the product catches fire, we recommend that you use the fire extinguishers in the following order: water or water mist, sand, fire blanket, dry powder, and finally a carbon dioxide fire extinguisher.
12. Use a dry cloth to clean off dirt on the product ports.
13. Rest the product on a flat surface to avoid damages caused by the product falling over. If the product is overturned and severely damaged, turn it off immediately, place the battery in an open area, keep it away from combustible matter and people, and dispose of it in accordance with local laws and regulations.
14. Ensure that the product is kept out of reach of children and pets.
15. Smart extra battery can't be used separately. DO NOT connect the smart extra battery to another smart extra battery.

### 2.2 Disposal Guide

1. If conditions permit, make sure that the battery is fully discharged before disposing it in a designated battery recycling bin. The product contains batteries with potentially dangerous chemicals, so it is strictly prohibited to dispose of it in ordinary trash cans. For more details, please follow the local laws and regulations on battery recycling and disposal.
2. If the battery cannot be fully discharged due to a product failure, please do not dispose of the battery directly in the battery recycling box. In such case, you should contact a professional battery recycling company for further processing.
3. Please dispose of over-discharged batteries that cannot be recharged.

# 3. Getting Started

## 3.1 Product Details

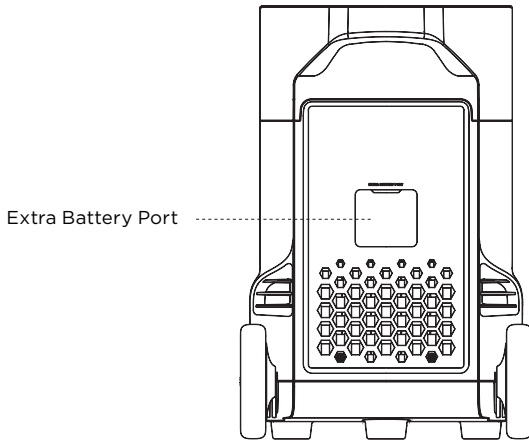
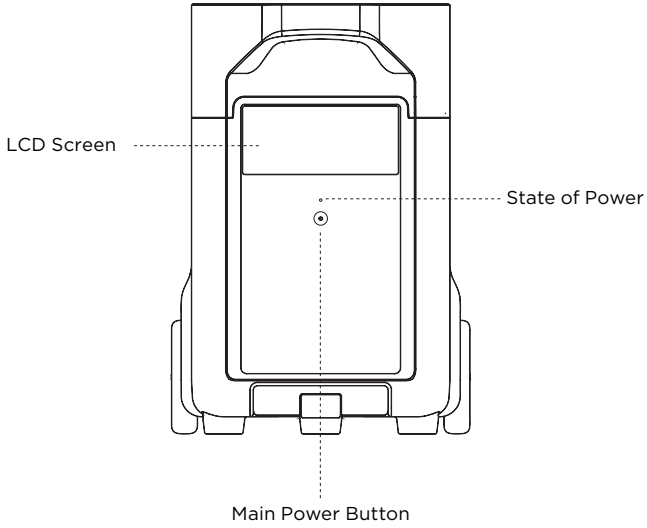

## 3.2 LCD Screen

Remaining Charge / Discharge Time

Remaining Battery Percentage

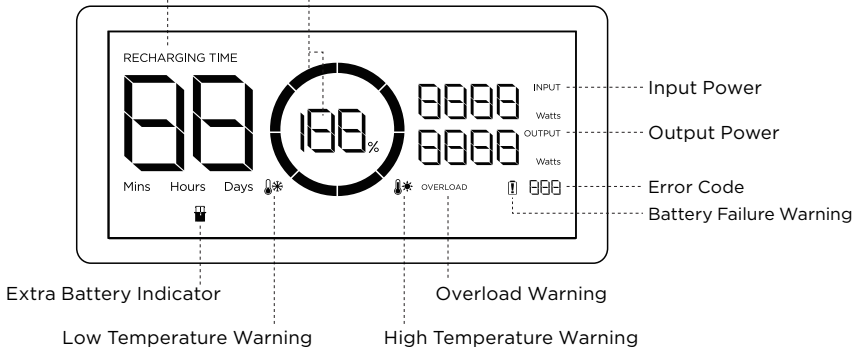

**Battery Level Indicator:** The indicator will repeatedly fill while charging. If product is at 0% charge, the indicator will flash to warn you.

\* See Section 5 for more troubleshooting steps.

## 3.3 General Product Usage

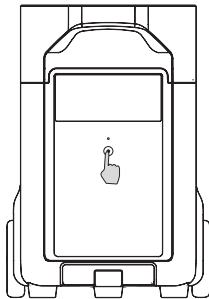

Short Press to Turn On

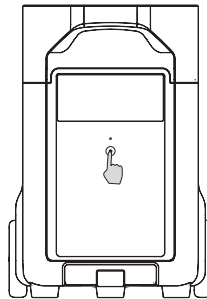

Long Press to Turn Off

### Product On, Product Off, LCD Screen On

**Short press the Main Power Button to turn on the product; the LCD Screen will light up and the battery level indicator icon will display.**

The product enters sleep mode after 5 minutes of idle operation; the LCD Screen will automatically turn off. When the product senses any load change or operations, the LCD Screen will automatically light up. To turn the LCD Screen on or off, please short press the Main Power Button.

**To power off the product, press and hold the Main Power Button.**

The default product standby time is 2 hours. With other Power Buttons turned off and no other load access for 2 hours, the product will automatically shut down. The standby time can be set on the app.

### For use along with DELTA Pro

DELTA Pro EB can be used with one or two DELTA Pro to meet more extensive capacity requirements.

Please carefully read the following notes before using:

1. Before connecting to the DELTA Pro and the Extra Battery, please make sure to power off the DELTA Pro and the Extra Battery.
2. After connecting the DELTA Pro EB to DELTA Pro, you need to make sure that the Extra Battery images appear on both the DELTA Pro and the Extra Battery screens. Charge or discharge the DELTA Pro EB after you have seen both images.
3. DO NOT connect the DELTA Pro EB to DELTA Pro while discharging or charging; if you need to remove the Extra Battery Cable, please make sure that the DELTA Pro EB and DELTA Pro are both powered off.
4. DO NOT touch the metal Extra Battery Port with your hands or other objects. Gently wipe it clean with a dry cloth when unrelated materials are attached to the metal port.
5. Tightly connect the Extra Battery Cable with DELTA Pro and the Extra Battery. Failing to comply may heat the connection and affect the device's performance or lead to a fire.

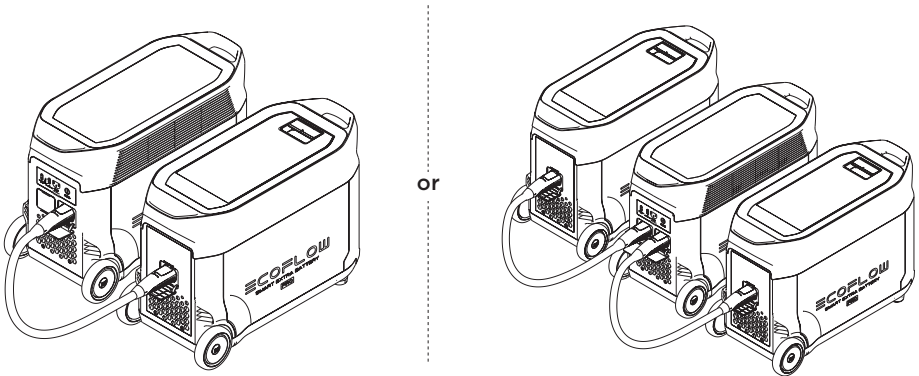

### For use along with Smart Generator

You may use DELTA Pro EB together with the Smart Generator. Please refer to the Smart Generator user manual for more details.

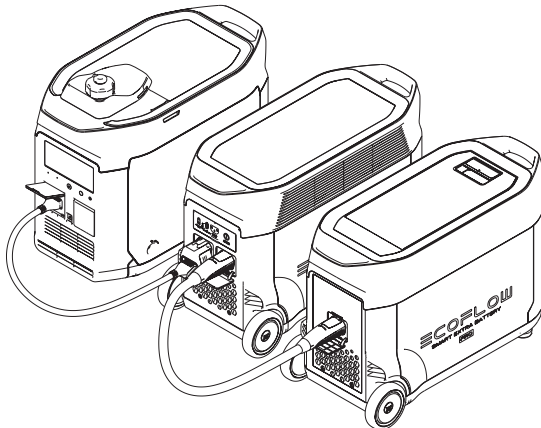

## 4. FAQs

### 1. What battery does the product use?

It uses high-quality LFP battery.

### 2. How long can the product charge my devices?

The charging time is shown on the product's LCD Screen, which can be used to estimate the charging time of most appliances with stable power usage.

### 3. How can I know if the product is charging?

When it's charging, the remaining charging time will be shown on the LCD Screen. Meanwhile, the charging indicator icon begins to rotate with the remaining battery percentage and the input power shown on the right of the circle.

### 4. How to clean the product?

Please gently wipe it with a dry, soft, clean cloth or paper towel.









### 5. How to store the product?

Before storing, please turn off the product first, and then store it in a dry, ventilated place at room temperature. Do not place it near water sources. For long-term storage, please discharge the battery to 30% and recharge it to 60% every three months to extend its battery life.

### 6. Can I bring the product on a plane?

No.

## 5. Troubleshooting

Indicator	Problem	Solution
RECHARGING TIME   Icons Flash together	High Temperature Charge Protection	Charging can be resumed automatically after the battery cools down.
  Icons Flash together	High Temperature Discharge Protection	The power supply can be resumed automatically after the battery cools down.
RECHARGING TIME   Icons Flash together	Low Temperature Charge Protection	Charging can be resumed automatically after battery temperature rises above 0 °C (32°F).
  Icons Flash together	Low Temperature Discharge Protection	The power supply can be resumed automatically after the battery temperature rises above -12 °C (10°F).
OVERLOAD Icon Flashes	Battery Overload Protection Short circuit protection during discharging	Remove high-power electrical appliances
 Icon Stays On	Battery Failure	Contact EcoFlow Customer Service

If the Alarm Prompt shows on the product LCD screen during use and does not disappear after a restart, please stop using it immediately (do not try to charge or discharge).

If you require any other assistance, please contact EcoFlow Customer Service.

## 6. What's In the Box

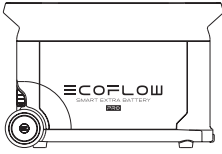

EcoFlow DELTA Pro  
Smart Extra Battery

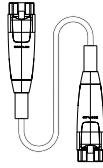

DELTA Pro Extra  
Battery Cable

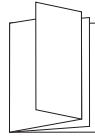

User Manual &  
Warranty Card

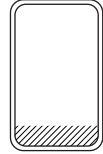

Handle Cover

## 7. Storage & Maintenance

1. Ideally, use and store the product between 20°C - 30°C (68°F - 86°F), and always keep it away from water, intense heat, and sharp objects. Do not store in temperatures above 45°C (113°F) or below -10°C (14°F) for an extended period.
2. Storing a battery with a low charge for a long period shortens its lifespan. DELTA Pro mitigates the damage by putting the battery into hibernation mode. To get the most out of the battery, make sure it is about 60% before putting DELTA Pro into long-term storage, and then once every three months, discharge the battery to 30% and recharge it back to 60%.

## 8. Fcc Statement

**This device complies with Part 15 of the FCC Rules. Operation is subject to the following two conditions:**

- (1) This device may not cause harmful interference, and
- (2) This device must accept any interference received, including interference that may cause undesired operation.

**Warning:** Changes or modifications not expressly approved by the party responsible for compliance could void the user's authority to operate the equipment.

**NOTE:** This equipment has been tested and found to comply with the limits for a Class A digital device, pursuant to part 15 of the FCC Rules. These limits are designed to provide reasonable protection against harmful interference when the equipment is operated in a commercial environment. This equipment generates, uses, and can radiate radio frequency energy and, if not installed and used in accordance with the instruction manual, may cause harmful interference to radio communications. Operation of this equipment in a residential area is likely to cause harmful interference in which case the user will be required to correct the interference at his own expense.