

NOVELTIES 2026

Fullfilling Expectations.



4 - 16



STAINLESS STEEL LUMA	4
ELITE SHOWER SYSTEM	5
CONCEALED SHOWER TAPS	6
BATHROOM ACCESSORIES	7
ELITE SLIM	8
ELITE KITCHEN	10
ELITE BATHROOM	12
LINO	14
SQ	16

20 - 47



 **Herz**[®]
UNITAS[®]

Fulfilling Expectations.



European Company. Since 1933.

NEW



Luma j12



- 00620SS
- 00620BC
- 00620BG
- 00620GM



Luma j10



- 00610SS
- 00610BC
- 00610BG
- 00610GM



Luma j50



- 00510SS
- 00510BC
- 00510BG
- 00510GM



Luma j30



- 00310SS
- 00310BC
- 00310BG
- 00310GM



Luma j40



- 00410SS
- 00410BC
- 00410BG
- 00410GM



Luma a320

- 12070SS
- 12070BC
- 12070BG
- 12070GM



Luma a620

- 12010SS
- 12010BC
- 12010BG
- 12010GM



Luma a820

- 12170SS
- 12170BC
- 12170BG
- 12170GM



Luma a520

- 12670SS
- 12670BC
- 12670BG
- 12670GM



Luma 16010

- 16010SS
- 16010BC
- 16010BG
- 16010GM

ELITE SHOWER SYSTEM

NEW



Shower system e193



00333



Shower system e193B



00333B



Shower system e193BG



00333BG

NEW



Fresh termo f91



00399



**Fresh termo f93 /
f93B**



00400



00400B



Push mix p93



09420

BATHROOM ACCESSORIES

NEW

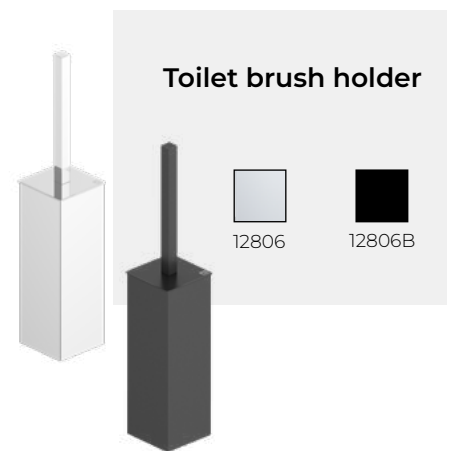
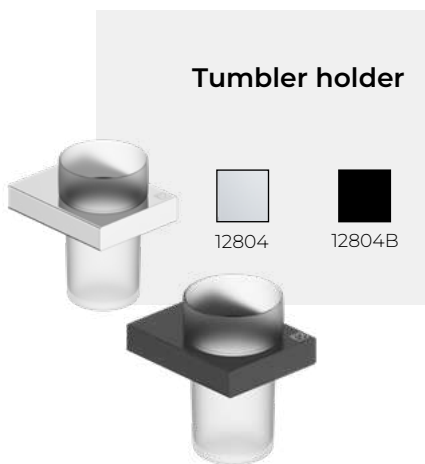











Elite e50B



00588B



Elite e11B



00088B



Elite e12B



00089B



Elite e50



00588



00586



Elite e11



00088



00086



00087



00085



Elite e12



00089



00079



00090



Elite e40B



00485B



Elite e30B



00373B



Elite e80B



00080B



Elite e40



00485



00486



00487



Elite e30



00373



00374



000375



Elite e80



00080





Lino I12



00096



Lino I11



00095



00078



Lino I50



00590



Lino I90



12268



Lino I91



12269



Lino I40



00490



Lino I30



00396





SQ q12B



00058B



SQ q50B



00595B



SQ q11B



00057B



SQ q40B



00494B



SQ q30B



00360B



SQ q12



00058



SQ q50



00595



SQ q11



00057



SQ q40



00494



SQ q30



00360



4 - 16



20 - 43



MULTIPOINT BALL VALVE	20
HERZ THERMIQ	22
AUTOMATIC FILLING VALVE	26
ZONE VALVE	27
HERZMAG	28
HERZMAG PRO	29
TMV	30
FROSTGUARD	31
PUMP GROUP SMARTCONTROL	32
PUMPFIX COMPACT DN20	33
PUMP GROUP	34
PUMPFIX SOLAR	36
HERZSOL	37
PUMP GROUP THERMO	38
BALL VALVES	39
STAINLESS STEEL MANIFOLDS	40
COMPOSITE MANIFOLDS	41
FLANGE VALVES	42
SAFETY VALVES	43

44 - 47

PRESSURE REDUCING VALVES	44
ANGLE VALVES	45
SANITARY MANIFOLDS	46
GARDEN VALVES	47



Fulfilling Expectations.



European Company. Since 1951.



MULTIPOINT Ball valve



DN

DN15-DN32

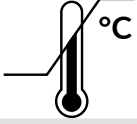

0,5 - 110°C





DN



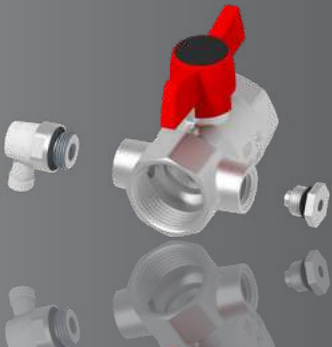

DN15-DN50



PN25

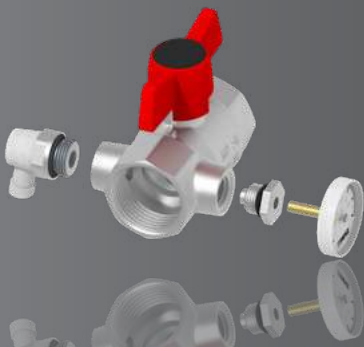

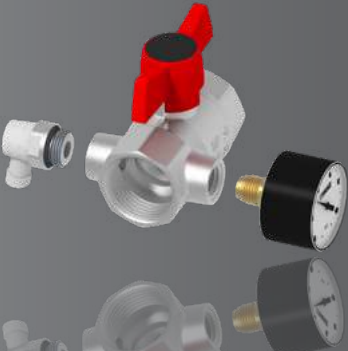
Drain 

Drain / fill 

DN32-DN50



NEW

MULTIPORT Ball valve

Options

A) Ball valve with drain valve (long and short handle).

DN15-DN25



DN32-DN50



B) Ball valve with drain valve extended version (long and short handle).

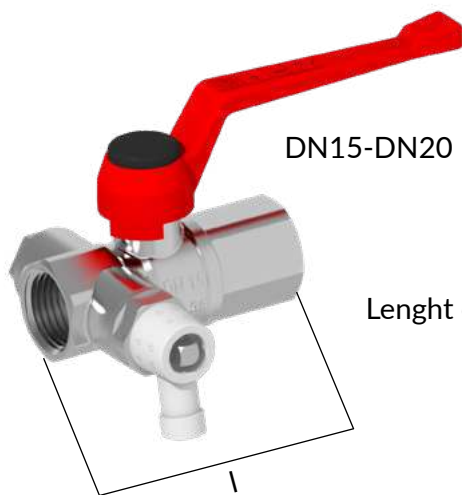

DN15-DN20

Length of the valve is the same like KV 402 / KV 403 version.

C) Ball valve with drain valve and M10 connection

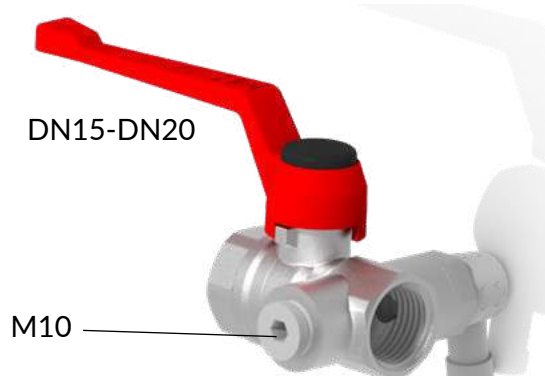

DN15-DN20

M10



HERZ Thermiq
technological heart of your home

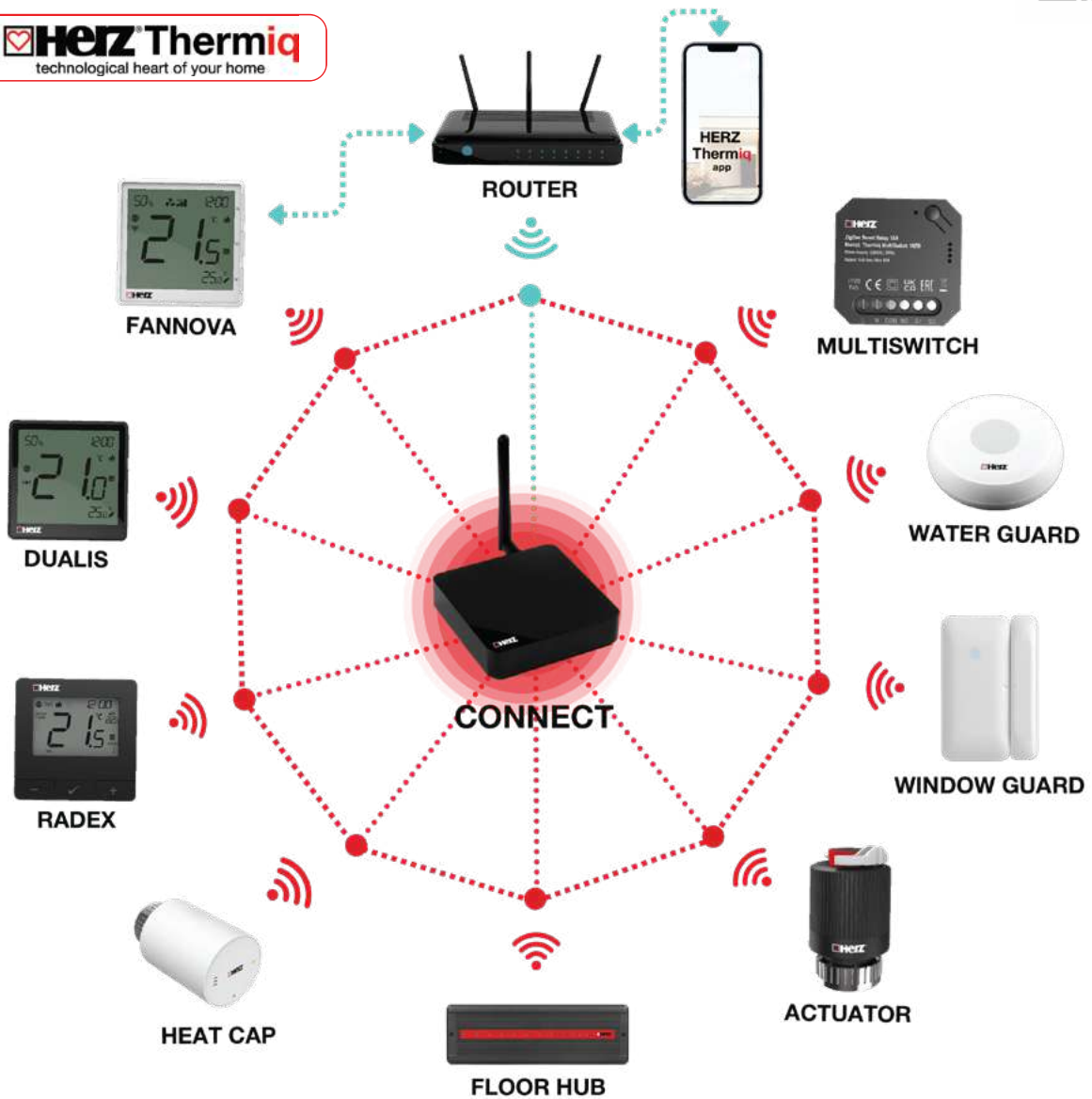

HERZ Thermiq



works with
Google Assistant

WORKS WITH
amazon alexa



Download on the
App Store

ANDROID APP ON
Google play



NEW



HERZ THERMIQ FANNOVA

Used for:

- Fan Coil - 2/4 pipe system
- Underfloor heating

WIFI, 230V

- 3 F820 41 – BLACK edition
- 3 F820 42 – WHITE edition



HERZ THERMIQ DUALIS

Used for underfloor heating

ZigBee, 230V

- 3 F820 21 – BLACK edition
- 3 F820 22 – WHITE edition



HERZ THERMIQ RADEX

Used for:

- Radiator system
- Underfloor heating

Zigbee, 230V

- 3 F820 31 – BLACK edition
- 3 F820 32 – WHITE edition





HERZ THERMIQ CONNECT

Smart Internet Gateway

ZigBee, WiFi, 230V
3 F820 71



HERZ THERMIQ FLOORHUB

Control Box for Underfloor Heating System

3 F820 11 – Wireless connectivity (6 wireless ZigBee zones + 2 wired zones, 230V)
3 F820 12 – Wired connectivity (6 wired zones, 230V)



HERZ THERMIQ ACTUATOR

Used for underfloor heating

230V, NC
3 F820 51 – M28x1,5
3 F820 52 – M30x1,5



HERZ THERMIQ ACTUATOR

Thermostatic radiator head

White, battery powered
3 F820 58 – M28x1,5





NEW



HERZ THERMIQ MULTISWITCH

Smart Relay

1x16A, NO-COM output, 230V
3 F820 65 – ZigBee connectivity
3 F820 66 – WiFi connectivity



HERZ THERMIQ WATERGUARD

Water leak sensor

Zigbee
3 F820 67



HERZ THERMIQ EXTEND

Repeater, increases the wireless range

3 F820 76 – Modular
3 F820 75 – Socket



HERZ THERMIQ HEATGUARD

Temperature Sensor

Suitable for installation in the floor
3 F208 61



HERZ THERMIQ WINDOWGUARD

Door / window Sensor

3 F820 68





Automatic filling valve

- Installed in the water supply piping of closed heating systems
- Maintain a stable system pressure at a pre-set value

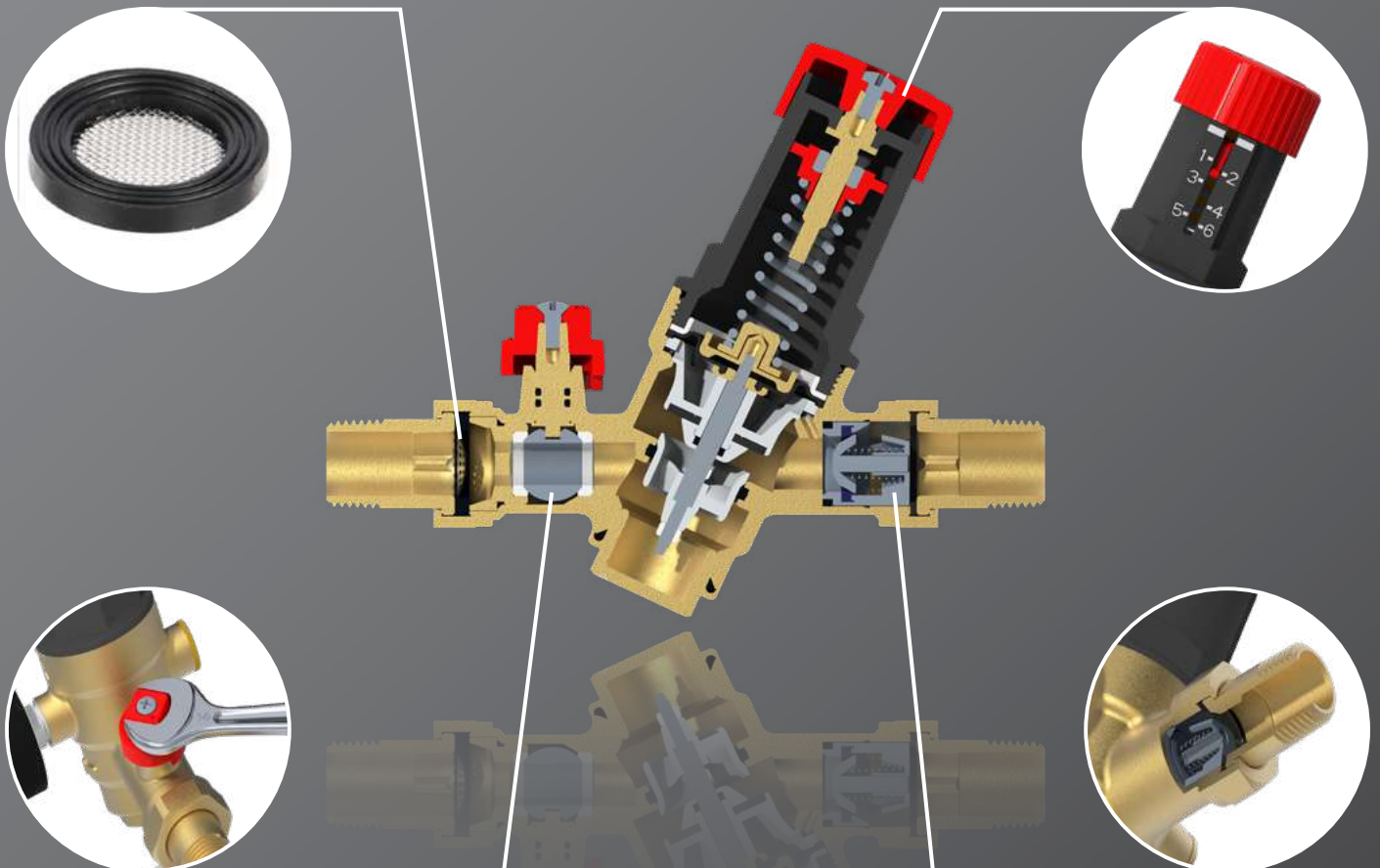
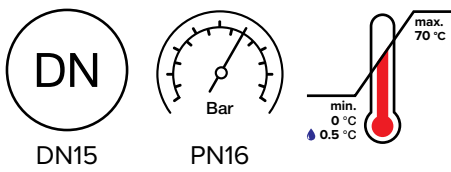
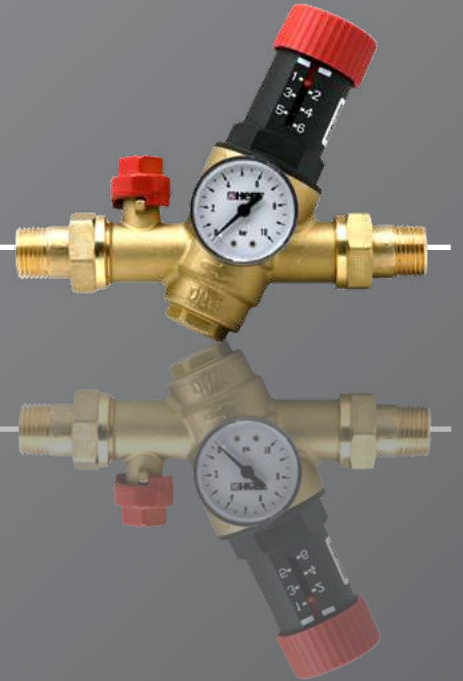



Zone valve



Quick response, energy efficiency



Tailored to your needs



Uncompromising quality



Versatile sizing

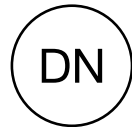

DN20-DN32



PN10

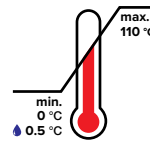

Compression ends

DN20
Cu22

DN25
Cu28

DN32
Cu35



External thread

DN20
G 3/4"

DN25
1"

DN32
G 1-1/4"

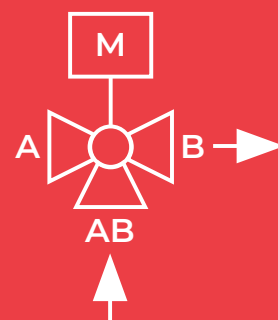
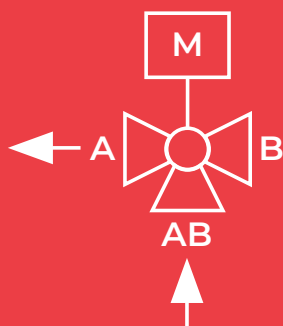



HerzMAG



DN20-DN25

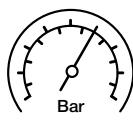

PN3

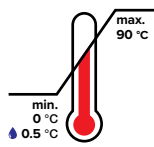

Nr.	DN	☒
1 1124 12	DN20	No
1 1301 02	DN20	Yes
1 1124 13	DN25	No
1 1301 03	DN25	Yes



T piece with 360 degree adjustment



Internal element with mesh and air vent



Rotatable connector



Magnets



Drain valve

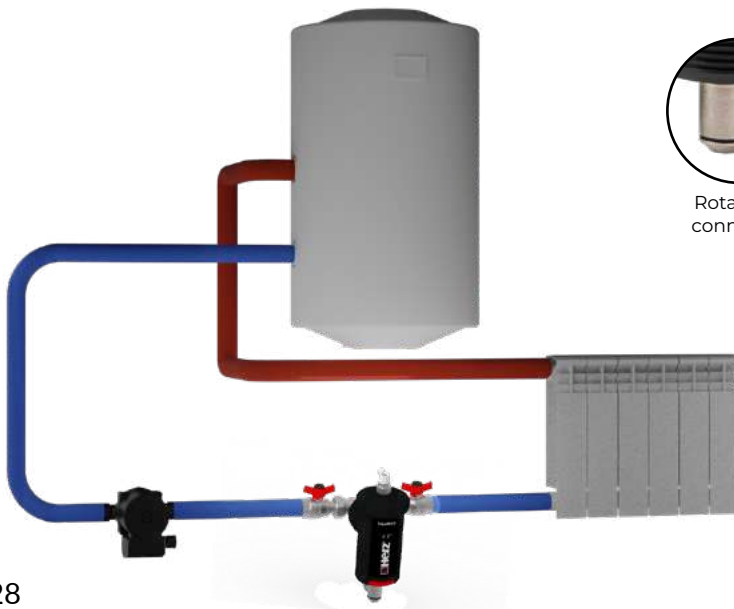



NEW



HerzMAG PRO



Technical specifications:

- DN: DN20-DN25
- Pressure: PN10
- Temperature range: min. -10 °C, max. 90 °C
- Temperature resolution: 0.5 °C

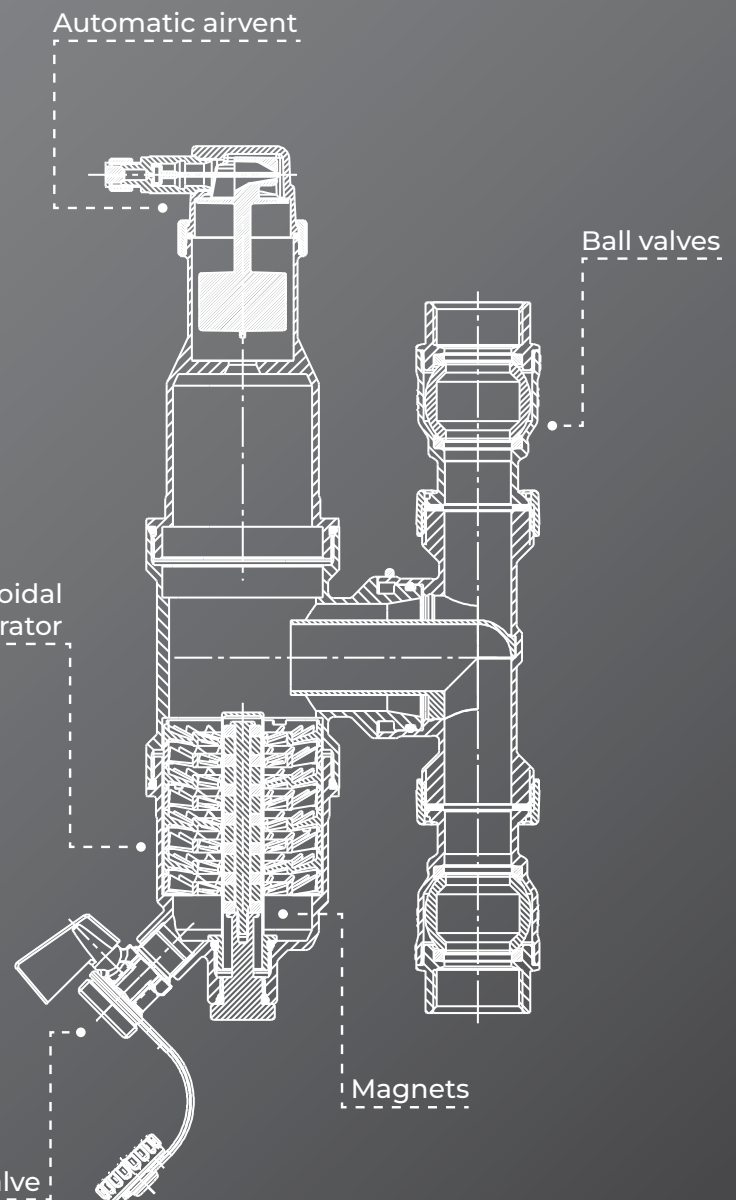

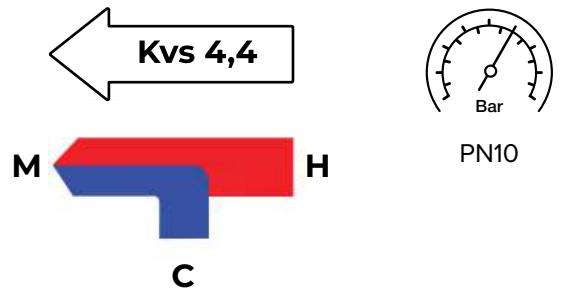
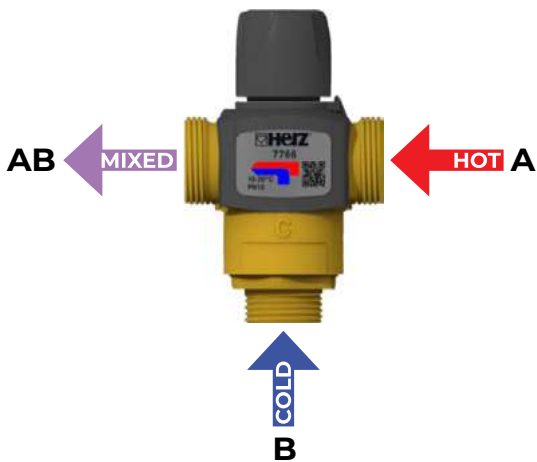

Heat pump - cooling

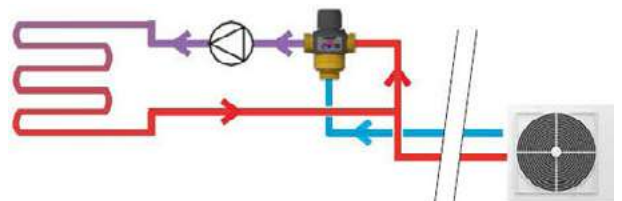

10 - 30 °C	Heat pump - cooling
20 - 45 °C	Floor heating
45 - 70 °C	Radiator heating

Floor heating

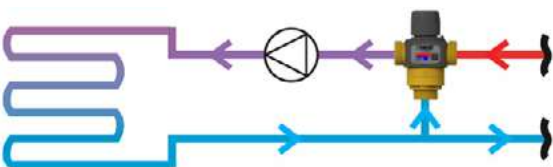

Radiator heating

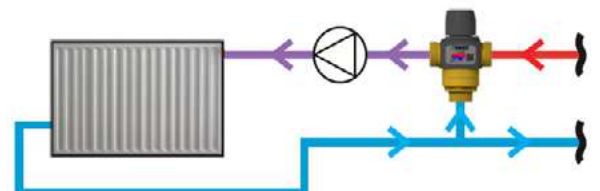



FrostGuard

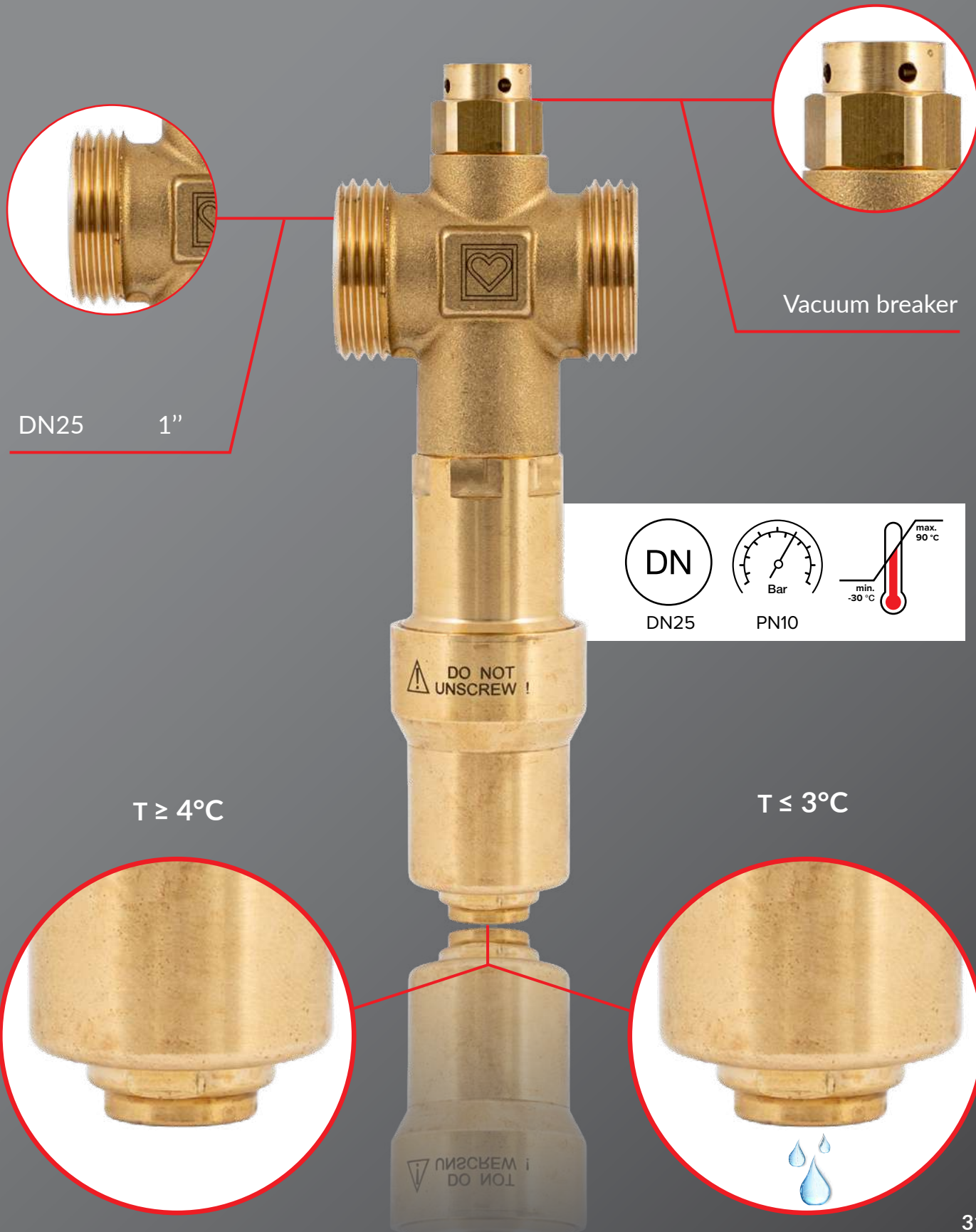



Pump group Smartcontrol

- Combining motor drive and controller in a single unit.
- No additional regulator needed - simple installation and reducing costs.

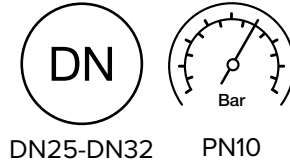

PUMPFIX SMARTCONTROL

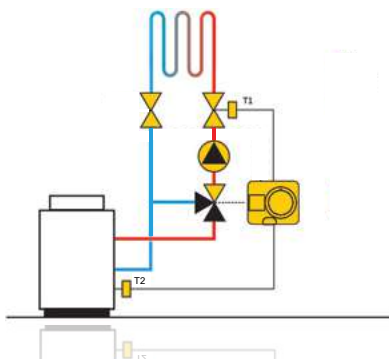

Clutch for manual operation



Setting keys



PUMPFIX SMARTCONTROL PLUS

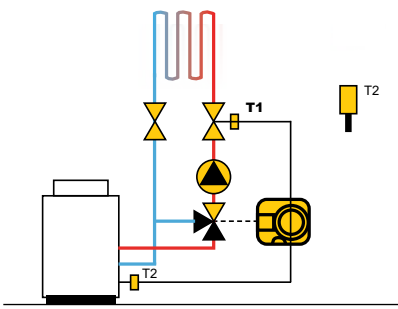

WEATHER COMPENSATED

Plug-in connectors



EUROMIX SMARTCONTROL

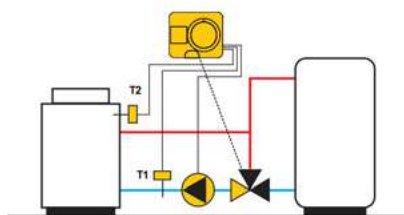

Graphic display





NEW



Pumpfix COMPACT DN20



Ball valve with thermometer and check valve



Wilo pump

DN
DN20

Bar
PN4



Dimensions:
410 x 410mm



Control knob for hydraulic switch

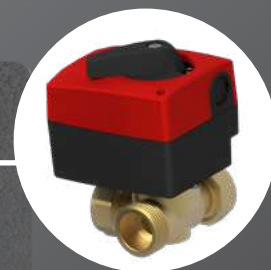

Three-way mixing valve + actuator



 **Pump group**

BRASS

STEEL

**Pumpfix
DIRECT
DN20 - DN32**



**Pumpfix
MIX
DN20 - DN32**



**Pumpfix
CONSTANT
DN25**



Pump group



**PF 4011
PF 5011**
DN40 - DN50



**PF 4001
PF 5001**
DN40 - DN50



**PR 2512
-
PR 3215**
DN25 - DN32



PR 5013
DN50



PR 5012
DN50

 **Pumpfix SOLAR**

**Pumpfix
SOLAR DN20**

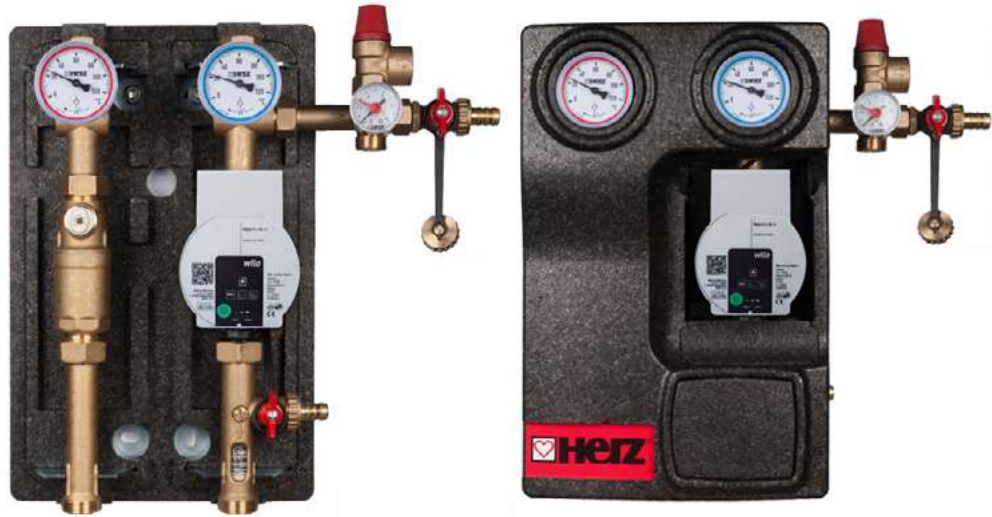

**Pumpfix
SOLAR
SIMPLE DN20**

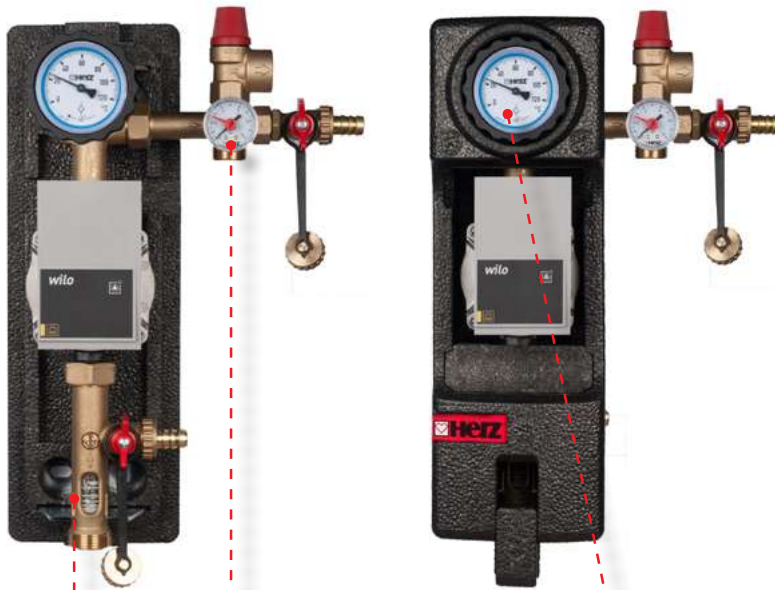

FLOW METER



SAFETY GROUP



INTEGRATED BALL WITH
NON-RETURN INSERT





NEW



HerzSol

Display:

128 x 64 px
monochrome



Power supply:

230 V AC (50 Hz)

AI:

5 x Pt1000
1 x 0-10 V
1 x 4-20 mA

AO:

1 x 0-10 V

DO:

1 x PWM

DI: 4 x optical isolated

DO: 4 x Triac (16 A)
2 x Relay (16 A)

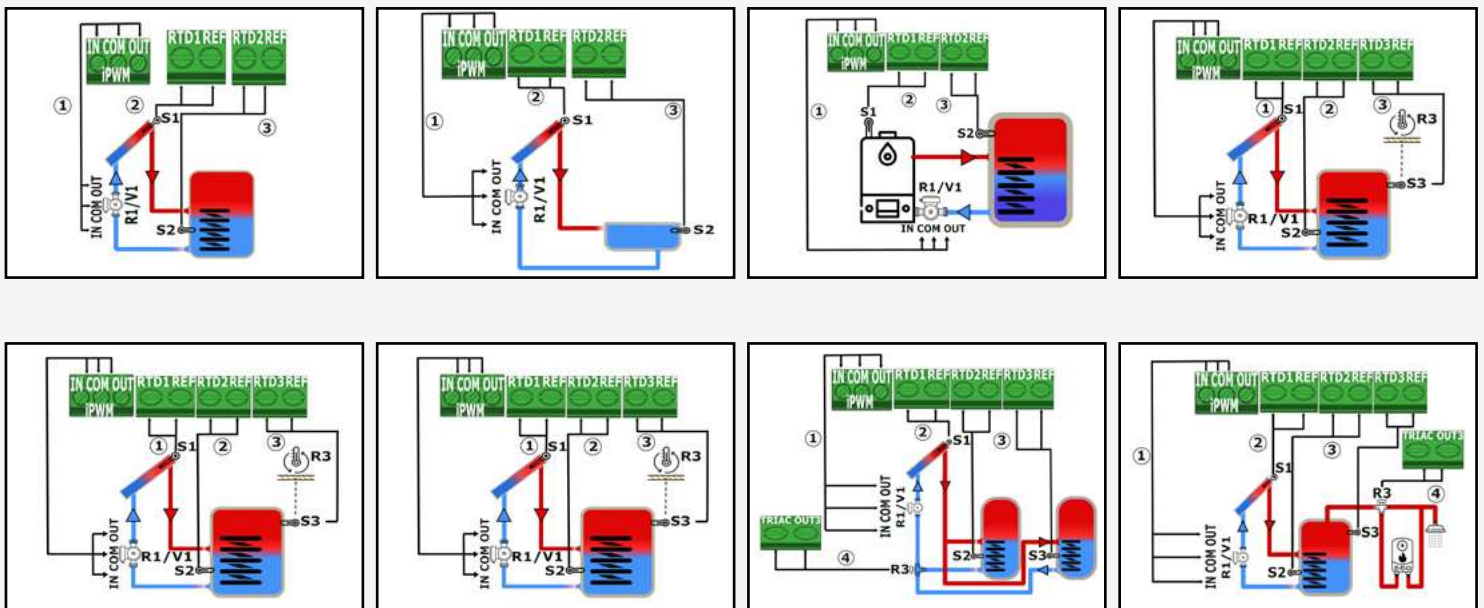

And more...

Pump group THERMO

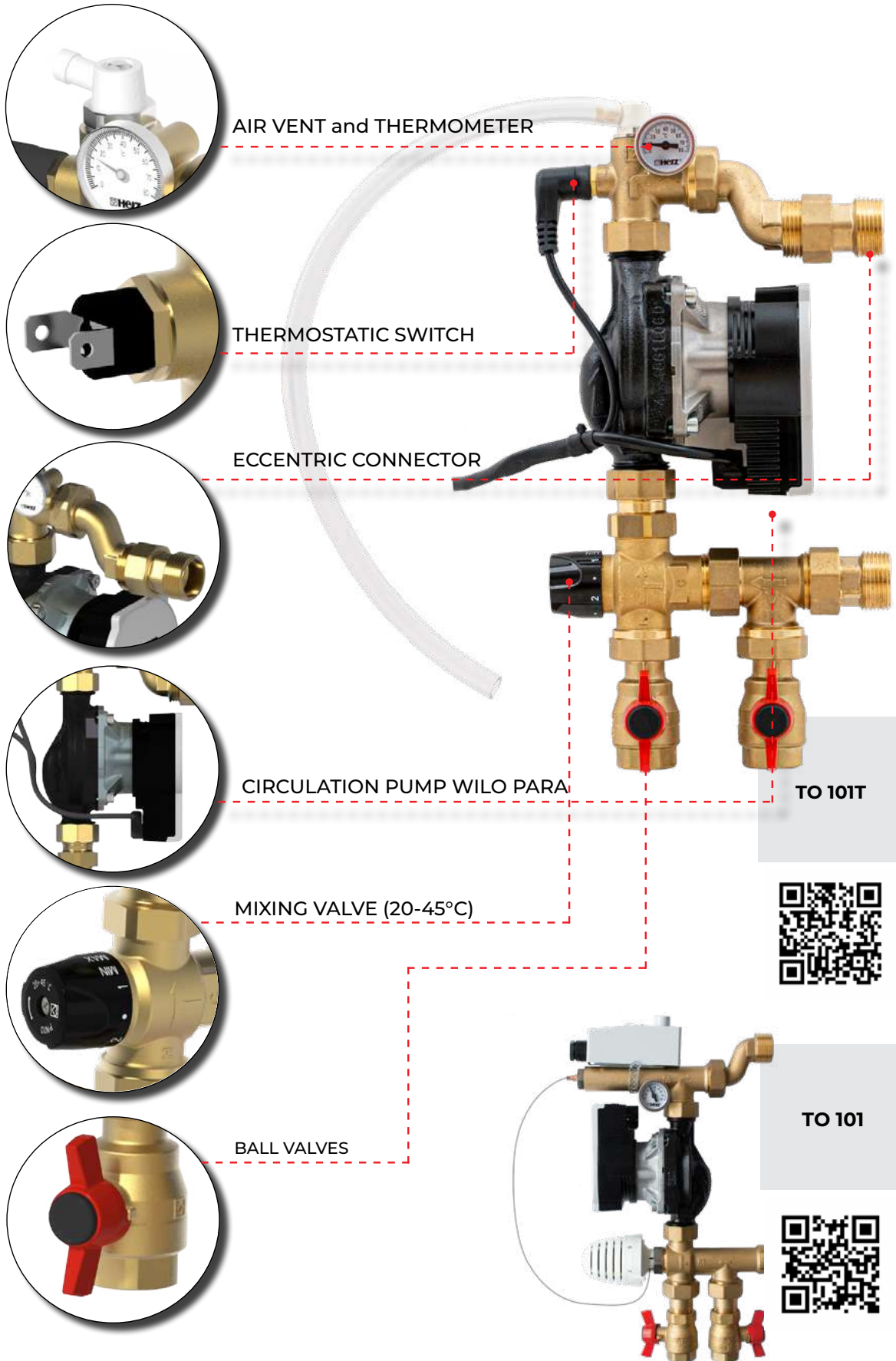

AIR VENT and THERMOMETER

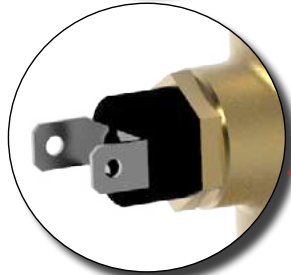

THERMOSTATIC SWITCH



ECCENTRIC CONNECTOR

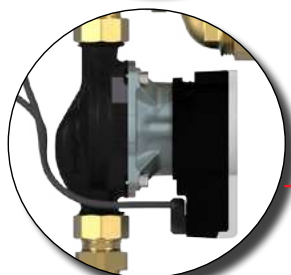

CIRCULATION PUMP WILO PARA

TO 101T



Bar
PN6



MIXING VALVE (20-45°C)

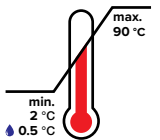

BALL VALVES

TO 101

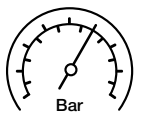

Bar
PN6

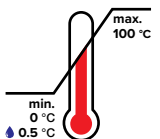

Ball valves

HEAVY TYPE

KV 100
-
KV 109
DN8-DN80

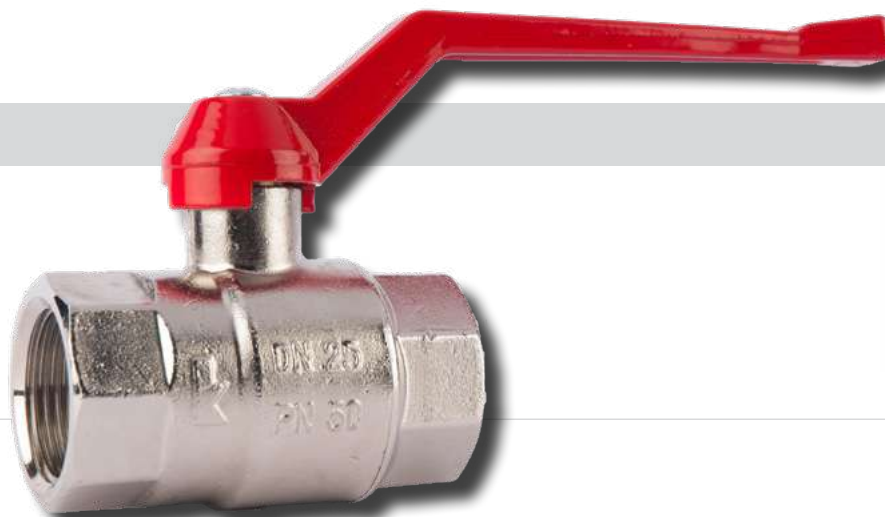

MODUL

KV 2102
-
KV 2107
DN15-DN50

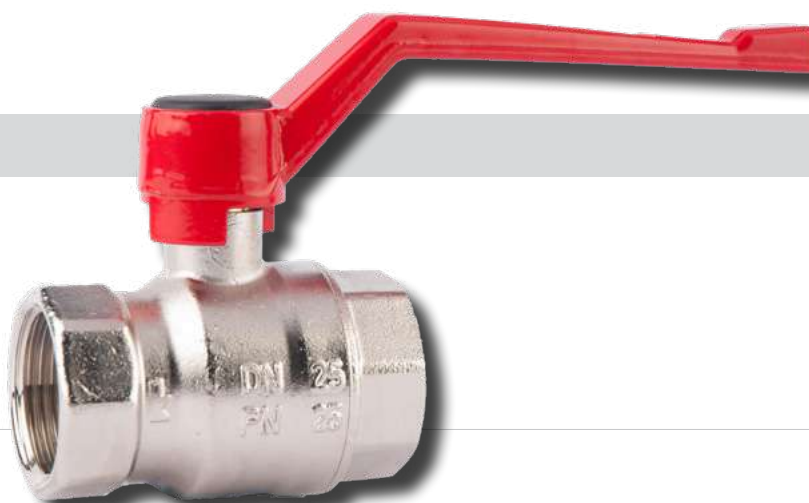

CLASSIC

KV 97X
-
KV 99X
DN15-DN50





Stainless steel manifolds

HERZ STANDARD

TO 103
-
TO 112



TO 203
-
TO 212

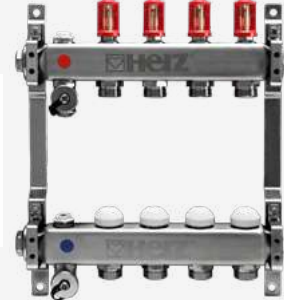

TO 403
-
TO 412



TO 303
-
TO 312



TO 202A
-
TO 216A



TO 302A
-
TO 316A

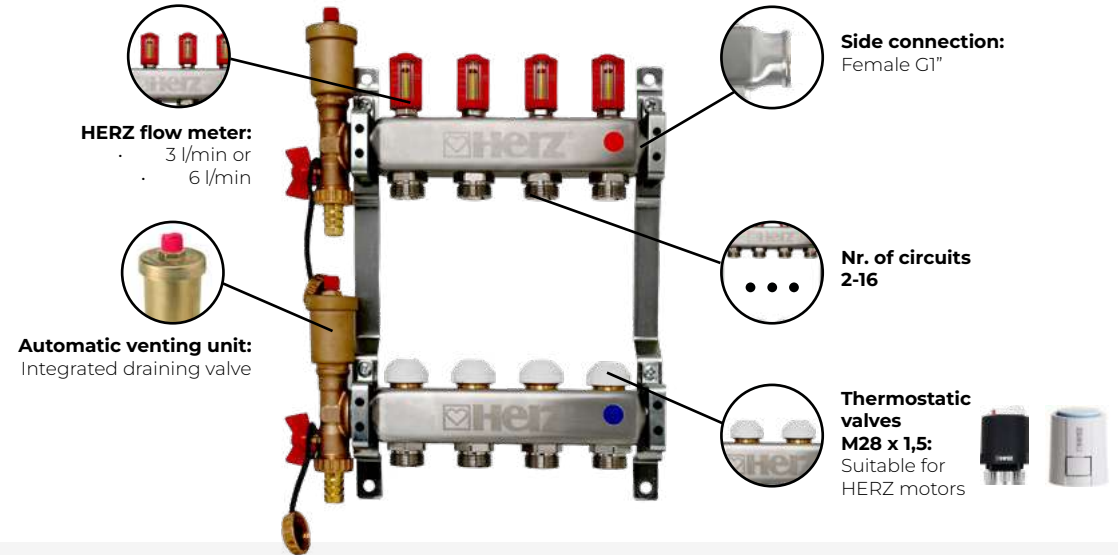

OEM VERSIONS:

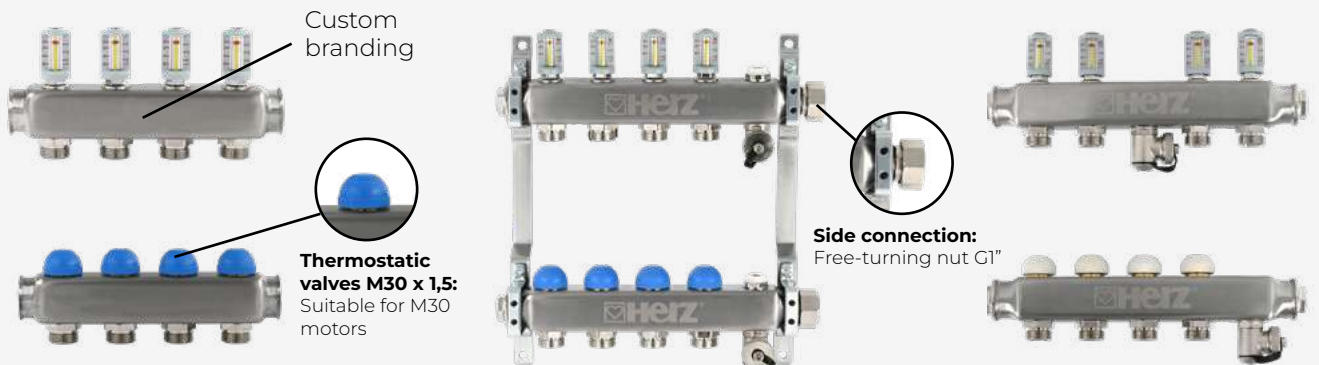

Composite manifolds

HERZ STANDARD

Side connections: Male 1-1/2"

Eurocone G3/4"

UNI - MULTI 2,4l/min

UNI - MULTI 8l/min

Nr. of circuits 2-16

2,4 l/min or 8 l/min

Side connections: Male 1-1/2"

Eurocone G3/4"

Side connections: Male 1-1/2"

Push fit: 16mm

UNI - TOP 2010M 2,4l/min

UNI - TOP 2010/16 2,4l/min

UNI - TOP 2010M 8l/min

UNI - TOP 2010/16 8l/min

Nr. of circuits 2-16

2,4 l/min or 8 l/min

Nr. of circuits 2-16

2,4 l/min or 8 l/min

OEM VERSIONS:

- Ball valve G1 - G1-1/2
- Thermometer 0°C - 60°C

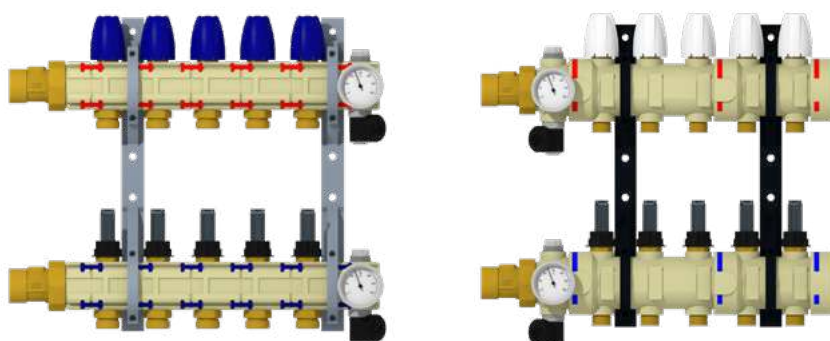



Flanged valves

Butterfly valves

1 4219 xx

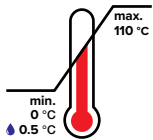

Waffer type or
Lugged type
DN50 - DN300

Stromax GMF

1 4218 xx

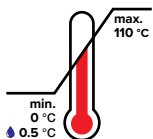

DN25-DN150

Stromax GF

1 4218 8x

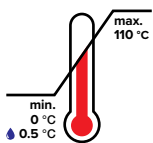

DN50-DN300

Check valve

3 2622 xx

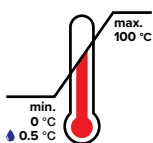

DN40-DN300

Safety valves

Airvent VO 628 VO 630

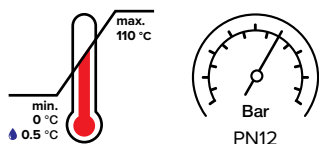

G 3/8" - G 3/8"
G 3/8" - G 1/2"

Check valve VP 642 VP 647

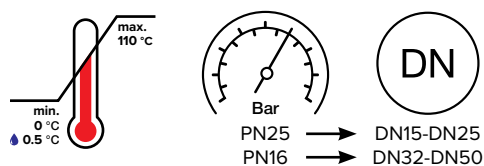

Airvent MICRO 1 2630 38

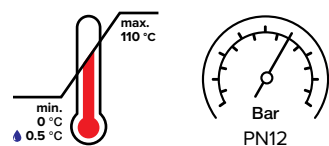

G 3/8" - G 1/2"

Pressure relief valve VV611 VV697



CE



Pressure reducing valves

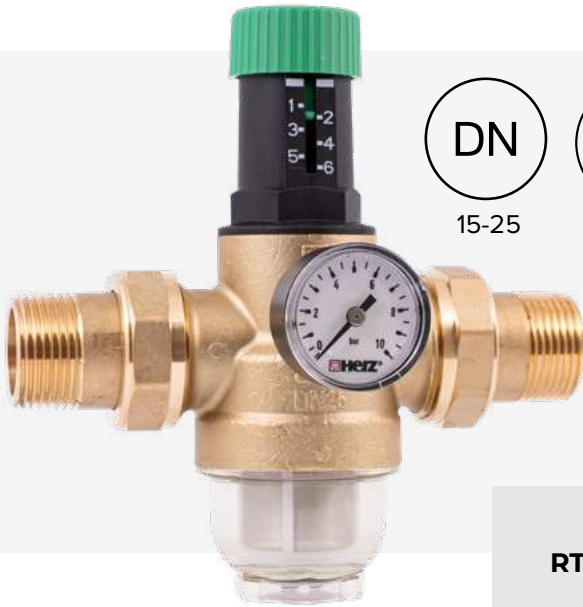

DN
15-25

Bar
PN16

min. 0 °C
max. 40 °C
0.5 °C

RT 692
-
RT 694



RTF 692
-
RTF 697



RT 695
-
RT 697

DN
DN32-DN50

Bar
PN16

min. 0 °C
max. 40 °C
0.5 °C





Angle valves

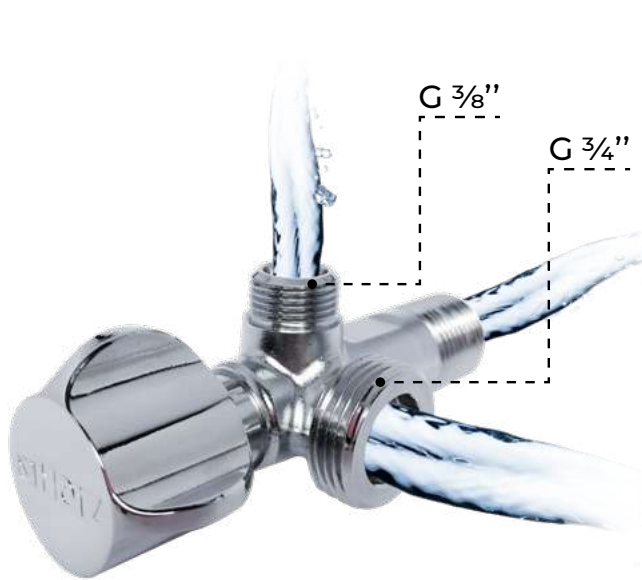

KV 555

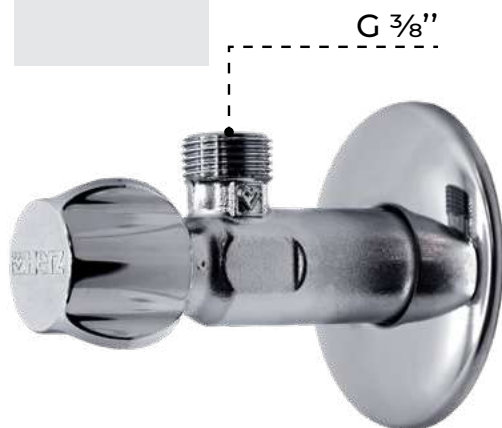

**LONG
KV 559**



KV 556

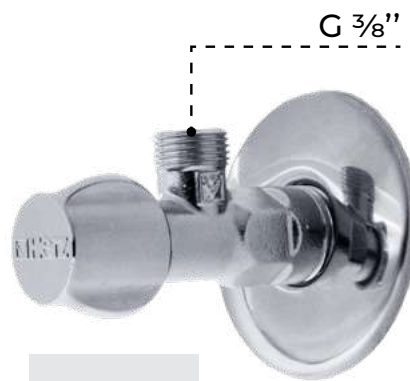

KV 557

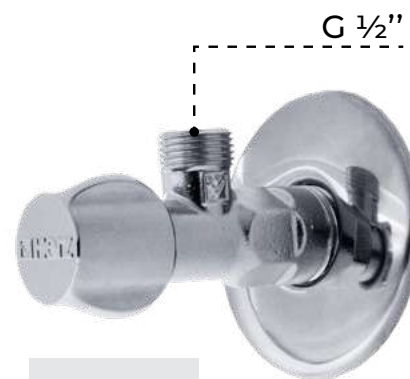

KV 558

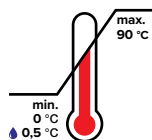

PN16





Sanitary manifolds

DN20:
RSV 102
-
RSV 104



Nr. of circuits:
2-4



DN25:
RSV 113
-
RSV 115



Nr. of circuits:
3-5

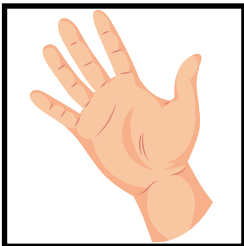

DN
DN20-DN25

Bar
PN10

max. 110 °C
min. 0 °C
0.5 °C

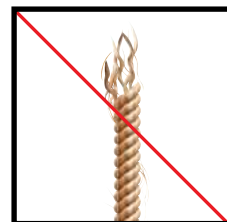
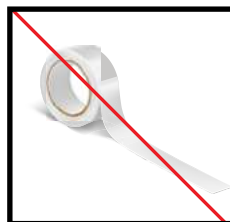
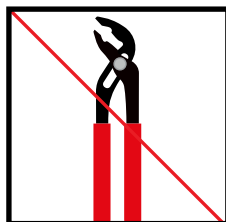
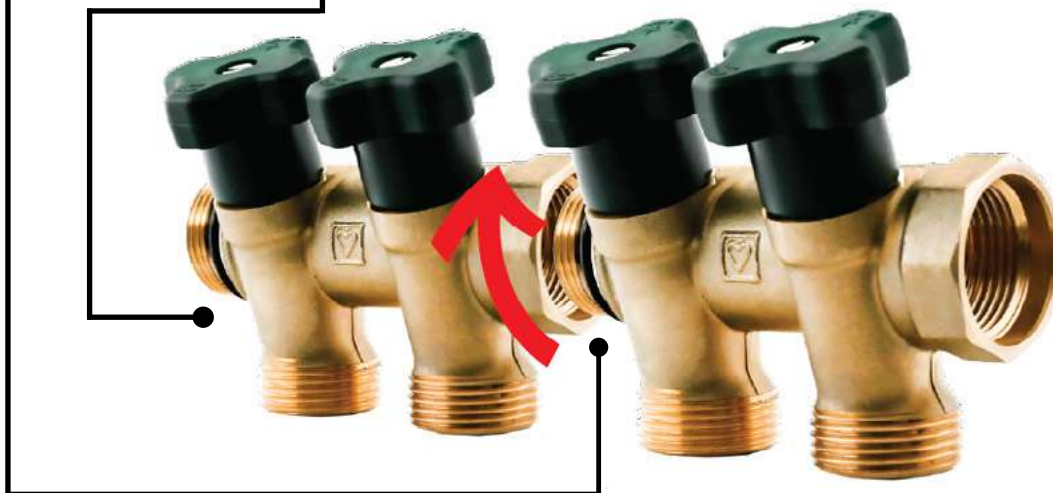



Garden valves



KP 532
-
KP 533



KP 532M
-
KP 533M



KP 502G M
-
KP 503G M



KP 502
-
KP 503



KP 510M
-
KP 522M



HERZ d.o.o.

Grmaška cesta 3
1275 Šmartno pri Litiji
T: +386 (0)1 896 21 02
F: +386 (0)1 896 21 40
E: info@herz.si
W: www.herz.si

