

cra'ster

2025-26 COLLECTION



The Future of Luxury Hospitality: Elevating Design and Experience



Luxury hospitality is evolving, with the world's leading hotels redefining excellence through adaptable, sustainable, and experience-driven spaces. Today's chefs and F&B leaders seek more than well-designed products—they need intelligent solutions that blend efficiency with aesthetics to create exceptional guest experiences.

At Craster, we craft purposeful solutions trusted by the most discerning hospitality brands, enhancing operational flexibility, streamlining planning, and elevating service.

Innovating for a dynamic future

Stak and Fare evolve further, enabling transformative spatial configurations that adapt throughout the day—minimising inventory while maximising impact. The Tilt collection expands with the introduction of our first fine bone china coupe selection, chosen for its exceptional durability, lightweight material, and refined aesthetic. Tilt Mini enhances service versatility, offering seamless interoperability across breakfast, lunch, and evening dining.

Sustainability remains central to our philosophy. Our new Tilt yoghurt dispenser significantly reduces single-use plastics, reinforcing our commitment to longevity and responsible design.

Designed to last, inspired by hospitality

True hospitality lies in the details: seamless service, intuitive design, and thoughtful touchpoints that surprise and delight. As Will Guidara shares in 'Unreasonable Hospitality', exceptional service isn't just about meeting expectations—it's about creating something unforgettable.

At Craster, we share this belief, providing chefs, designers, and operators with the tools to craft extraordinary experiences. Inspired by those who bring our products to life, we look forward to shaping the future of hospitality together.

Let's create the future together.

Alex Craster

craster

Design Studio

- 4 Craster Design Studio
- 6 Product Design
- 8 Space Curation
- 10 Shop the Look

Food & Beverage

BUFFET

- 16 Flow
- 52 Tilt
- 90 Alto

TABLE TOP

- 98 Boards
- 104 Chip Pots
- 106 Shaker
- 108 Solo
- 110 Porcelain
- 112 Olive Wood Bowls
- 114 Patisserie
- 118 Cake Stands
- 120 Rustic

FURNITURE

- 124 Fare
- 134 Stak

IN-ROOM DINING

- 144 Trays
- 147 Folding Tray Table

CONTRACT

- 150 Wave
- 151 Service Trolleys

Conference, Events, Banqueting

- 154 Line
- 170 Link
- 178 Rise

Bedroom

- 188 Tea Service
- 190 Amenities Presentation
- 192 Luggage Racks
- 193 Shaker Bins and Storage

Key to product symbols



Dishwasher Safe*



Made to Order



Cooling



Heating

• Black dots denote 'Gold' products

e.g. BU_FR008 •

We aim to hold stock on all 'Gold' items in our warehouses to cover regular orders of these popular products.

*Please note: not all our products are dishwasher safe. Unless specified otherwise, we recommend hand washing to maintain their quality and longevity. For detailed care instructions, please refer to the product-specific guidelines provided on our website or contact our customer service team.

Craster Design Studio

Craster Design Studio is a team of experienced industrial and interior designers and developers. We focus on product creation and space curation for the hospitality industry.

The studio was born out of collaborations with hospitality professionals, operators and interior architects with the intent to create innovative and intelligent solutions. We derive our inspiration from the collaboration itself, the quality of materials, best-practice design methodologies and achieving functional excellence.

Our Design Philosophy

We create intelligently designed solutions that elevate hospitality experiences through a balance of form, function, and longevity. Our philosophy is centered on crafting refined, purposeful products that seamlessly integrate into luxury environments, enhancing both presentation and operational flow.

Our approach is guided by three key principles:

- Experiential craftsmanship—Every product is developed to create memorable, tactile interactions, considering proportion, usability, and aesthetic impact to enrich the guest experience.
- Versatile design thinking—Our collections are designed with adaptability in mind, allowing for seamless integration across different hospitality settings while maintaining a cohesive visual language.
- Sustainable longevity—We are committed to material integrity and meticulous craftsmanship, ensuring our products endure the rigors of hospitality service while reducing environmental impact.

By designing with both today and tomorrow in mind, we empower our clients to create hospitality moments that are both enduring and effortlessly elevated.

As a manufacturer, longevity is a powerful way to reduce our impact on the environment. We achieve this in a number of ways. We are uncompromising in the quality of materials we employ. We will always strive to eliminate the extraneous. And we care about build quality and detail. Many of our products are still working hard in relentless hospitality environments 15 years after being introduced into service.

Alex Craster, Founder of Craster

Product Design

Combining Client Collaboration and Bespoke Manufacturing

In the competitive world of premium hospitality, delivering unique guest experiences is essential.

At Craster, we help clients stand out with custom-designed products that blend aesthetics, functionality, and craftsmanship.



Tailored to Your Vision

Every hospitality space is unique, and our Custom Design Service enables clients to create bespoke solutions that align seamlessly with their brand identity and operational needs.

Whether refining existing designs or developing something entirely new, we collaborate with leading hotels and restaurants to craft exclusive solutions that elevate both style and service flow.

Crafted for Quality and Longevity

Each bespoke piece is built to last, reflecting the same precision, sustainability, and intelligent design as our core collections. Clients can expect meticulous craftsmanship and hospitality-grade durability, ensuring consistency across both standard and custom solutions.

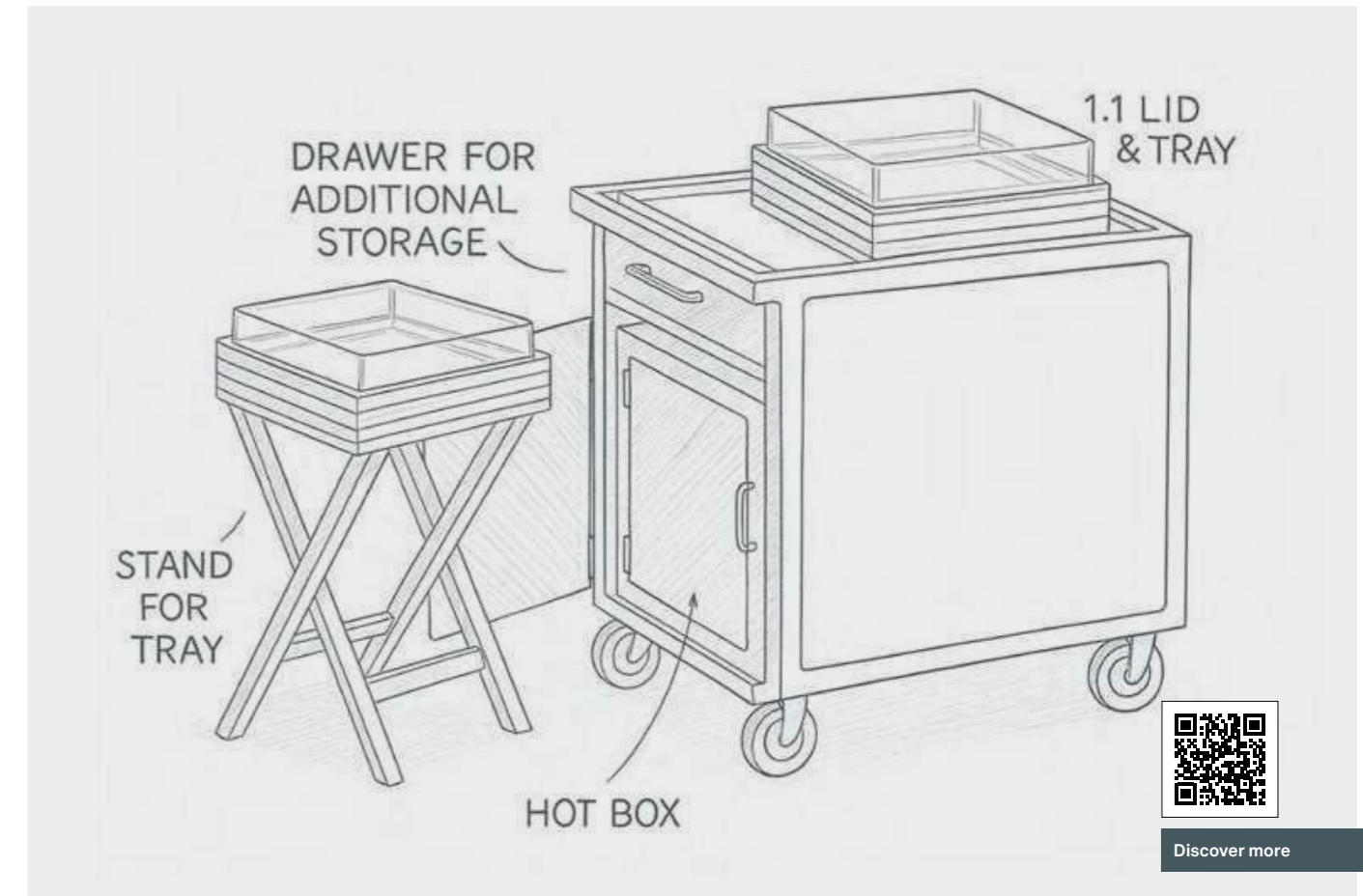

Discover more

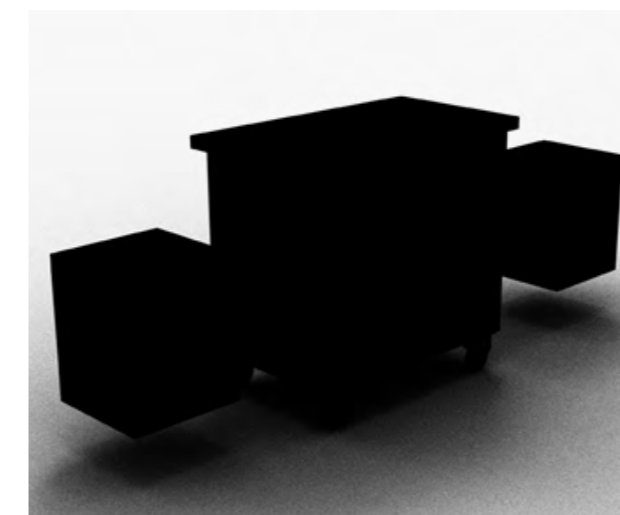

Our Collaborative Process

- Consultation and concept development: Understanding brand positioning, operational requirements, and design intent.
- Design and prototyping: Refining concepts into functional, manufacturable solutions.
- Precision manufacturing: Using premium materials and expert craftsmanship to ensure lasting quality.
- Seamless delivery and support: Reliable production, global logistics, and ongoing client assistance.

Contact your Craster representative to collaborate on distinctive, high-performance hospitality solutions.

Space Curation

Our PLAN 2.0 software makes designing, refining, and visualising hospitality setups effortless.

Start with a photo: upload an image of your space for a real-world reference. Then, explore Craster's curated product library to configure trays, dispensers, and modular displays with ease.

Whether designing a coffee station or any other F&B setup, PLAN 2.0 ensures an optimal balance of style and function. Its Augmented Reality (AR) feature places your design into the actual space, allowing teams to fine-tune product positioning for seamless service flow and accessibility.

Make smarter decisions, optimise service flow, and create beautifully functional spaces—all before placing an order.

Contact your Craster representative to explore PLAN 2.0 today.

Once final, share the design for quick approval, eliminating guesswork and streamlining execution.



Watch the video to see PLAN 2.0 in action

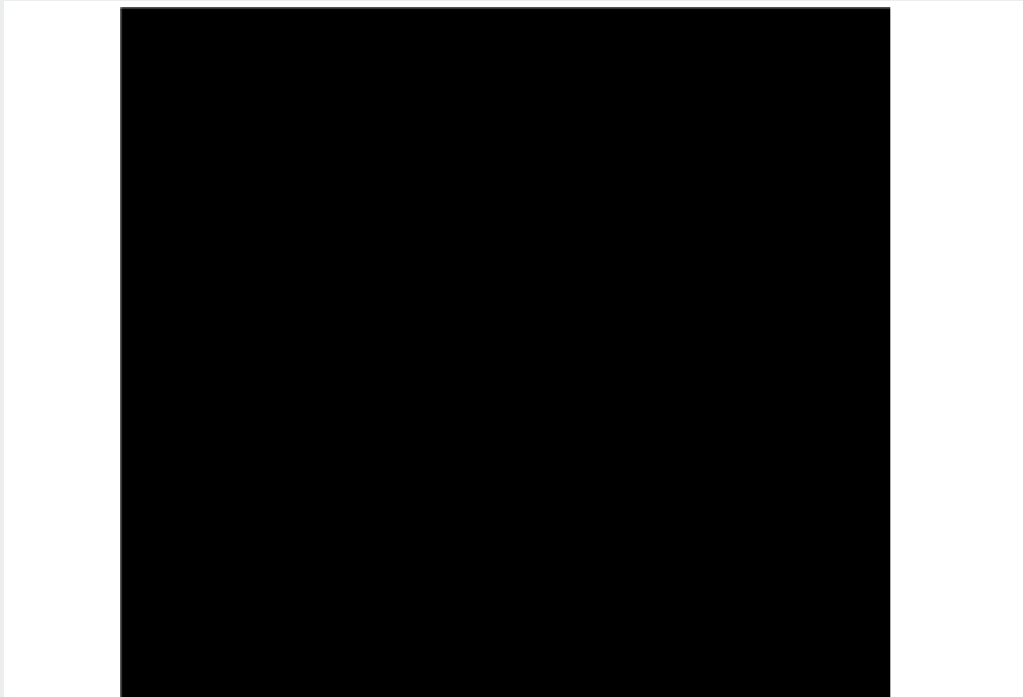

PLAN 2.0

- 1. Capture** an image of your space.
- 2. Curate** the Craster products on your wishlist using the 2D Floor Plan and 3D View features.
- 3. Create** a PLAN 2.0 visual of your space with the augmented reality feature.
- 4. Contact** your Craster representative to place your order.

PLAN 2.0: 2D view

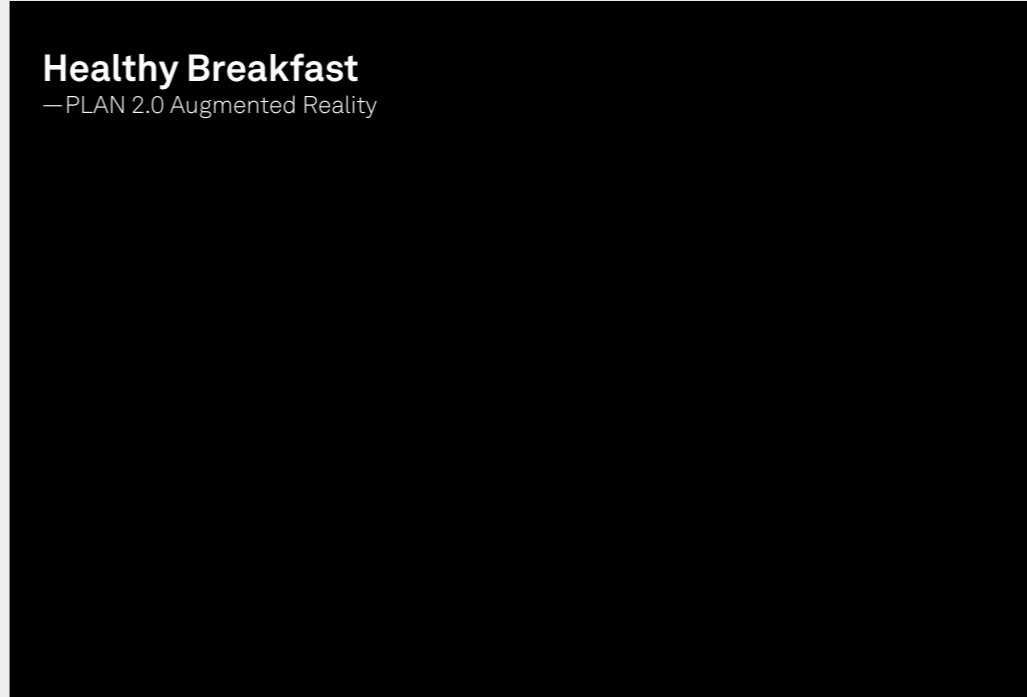

Healthy Breakfast — PLAN 2.0 Augmented Reality



Scan the QR code to view the Healthy Breakfast setup in PLAN 2.0 and 'Add or Remove items' to customise for your own set up.

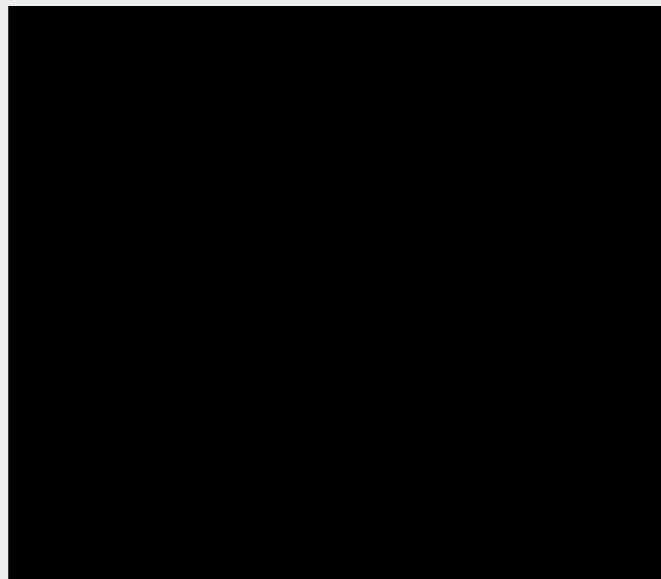
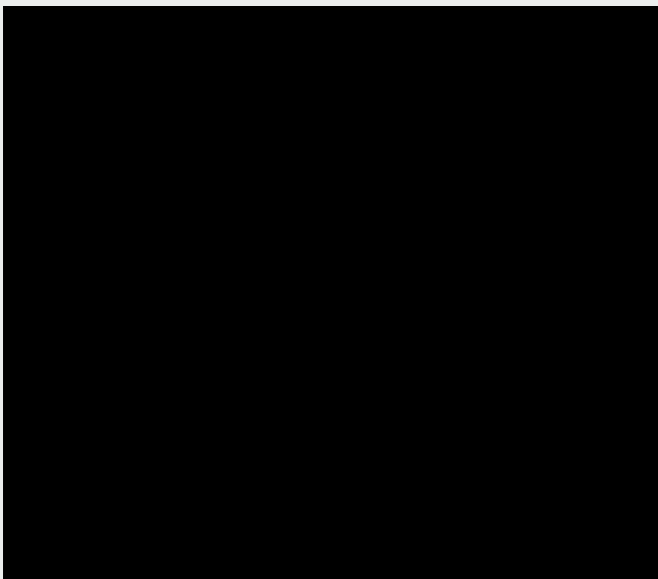

PLAN 2.0: 3D view

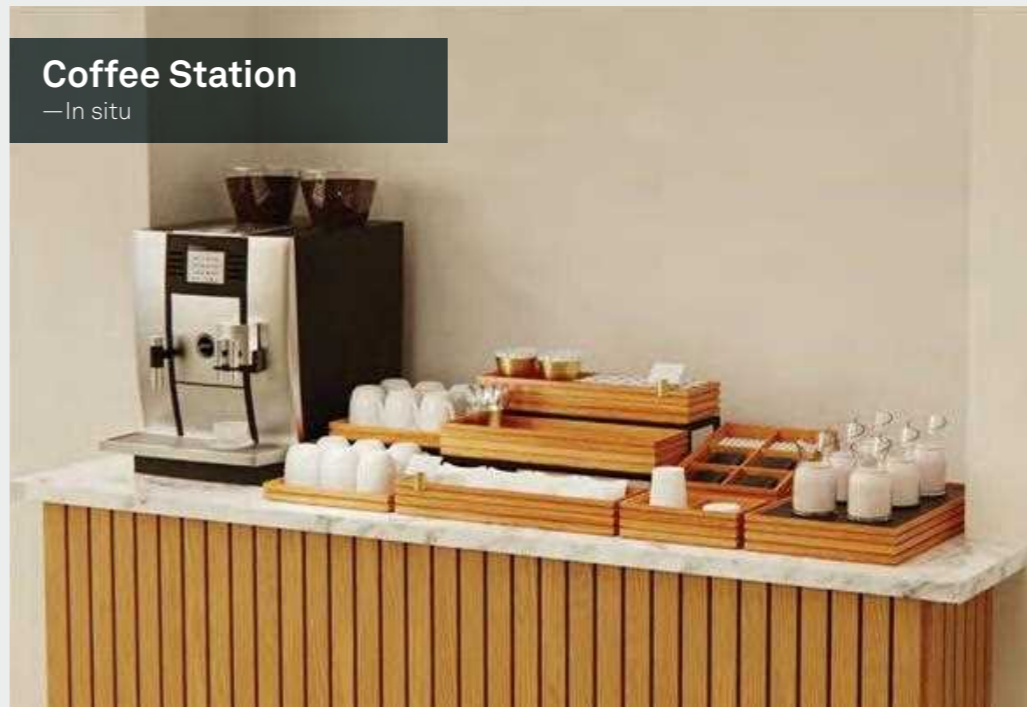

Coffee Station — In situ



Scan the QR code to view the Coffee Station in PLAN 2.0 and 'Add or Remove items' to customise for your own set up.

Shop the Look



Outdoor and Event Dining

Built for mobility and durability, Stak + Fare transitions effortlessly between indoor and outdoor service. Whether for al fresco dining, poolside refreshments, or large-scale events, the system ensures quick reconfiguration, weather-resistant performance, and a cohesive design aesthetic.

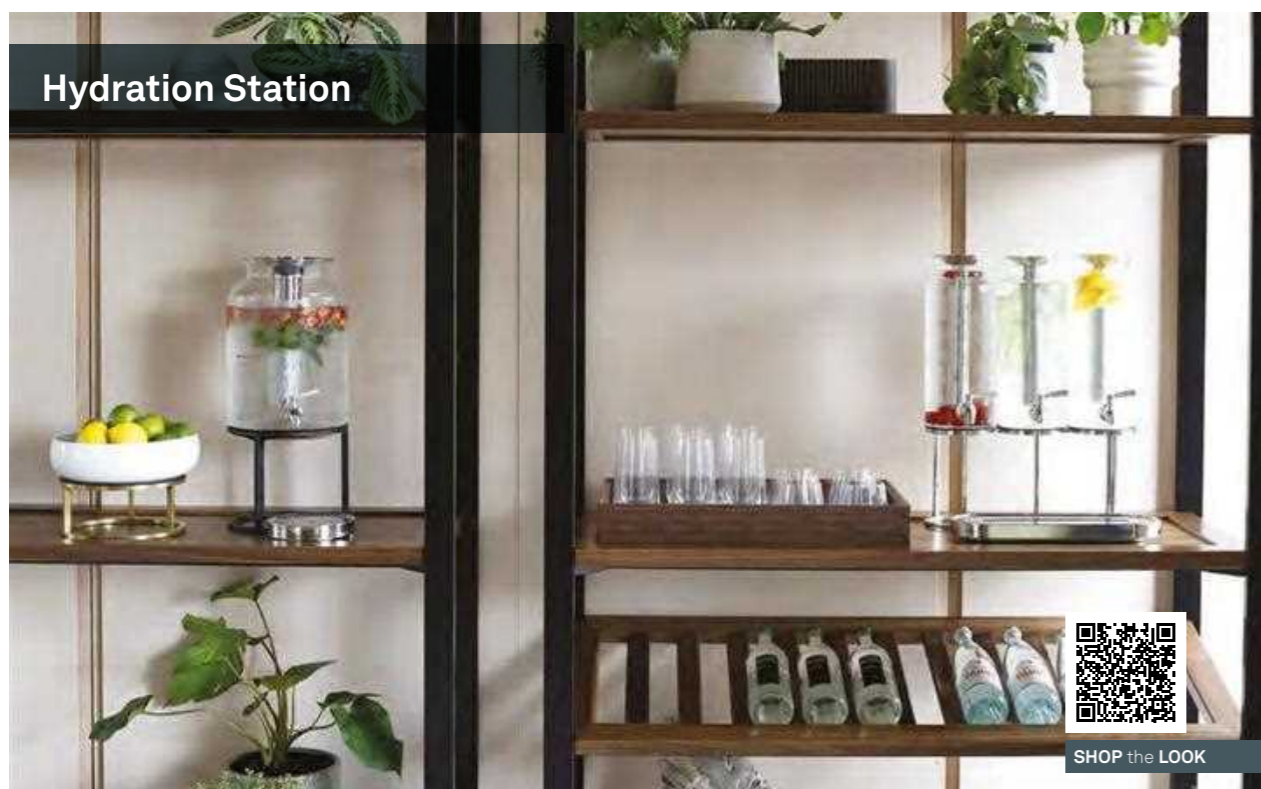

Seamless Hospitality, Minimal Inventory

A single framework, endless service moments. Stak + Fare reduces storage needs while enabling rapid transformation between multiple functions. Designed for efficiency, elegance, and adaptability, this system redefines mobile hospitality furniture with limitless possibilities and minimal footprint.

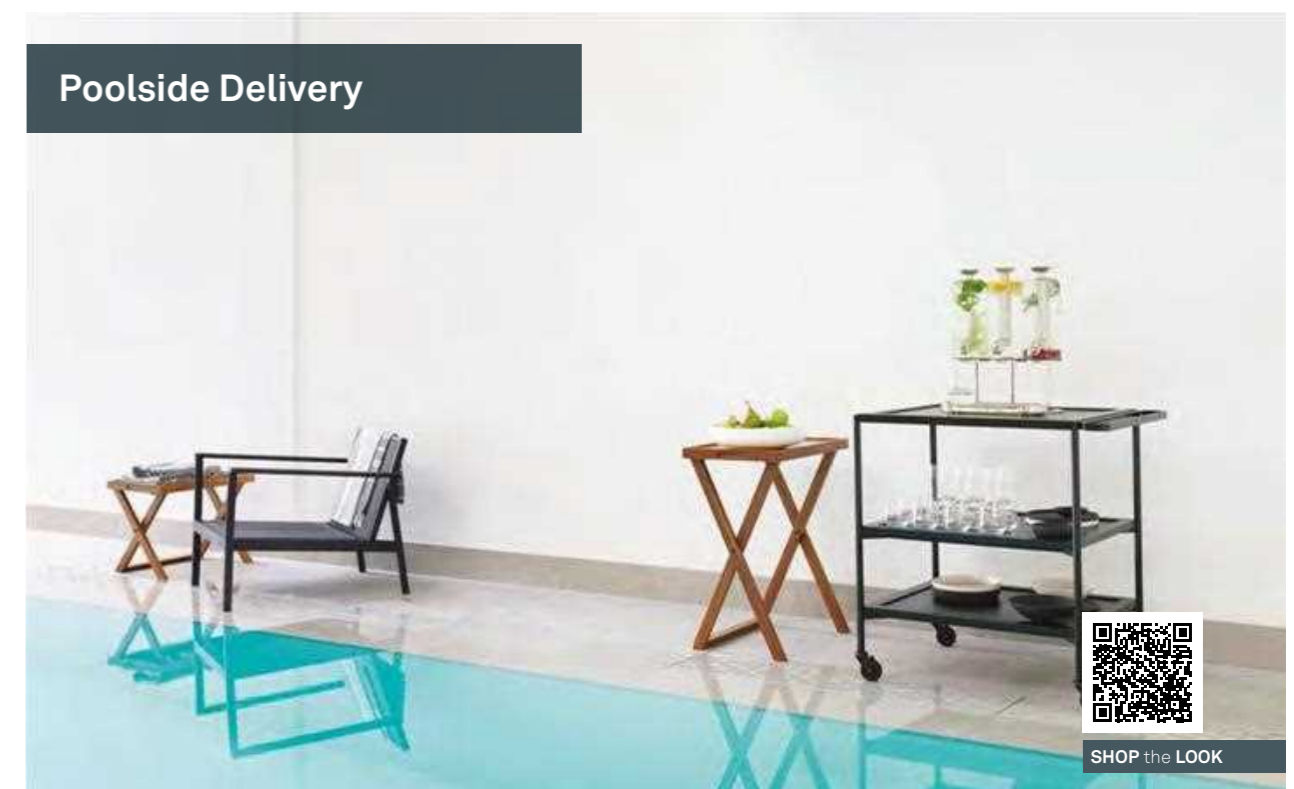

Shop the Look



Back Bar and Beverage Stations

From sophisticated back bars to cocktail stations, Stak + Fare offers intuitive, reconfigurable layouts that maximize space and efficiency. Shelving adjusts for easy bottle display and storage, while trolleys enable flexible front-of-house service and discreet replenishment.

Grab-and-Go and Self-Service Display

For high-traffic hospitality, efficiency and accessibility are key. Stak + Fare creates versatile grab-and-go stations that are easy to replenish and adapt throughout the day. Bridging elements expand merchandising space, while mobile trolleys shift seamlessly between breakfast, retail, and all-day dining.



Food & Beverage

BUFFET





Flow

- Versatile, modular display system based on a Gastronorm footprint.
- For ambient, hot, and cold setups.
- Stackable trays in walnut and oak finishes.
- Plinth tops in glass, marble, or wood, supported by stainless steel or black frames.
- Interchangeable components enable customised displays, efficient replenishment, and single-serve options.
- Create tailored displays by selecting size, frame, and top.
- Accessories include heating/cooling units, label holders, and lid liners.

Ideal for:
Unlimited presentation possibilities,
single and double-sided buffet display.



Discover more

How to Create Your Buffet with Flow

The Flow range is crafted around a gastronorm footprint, enabling you to create a custom display.

To build a display, simply select a gastronorm size, a frame (flat or angled), and a top (deep or shallow trays or flat plinths).

	Gastronorm sizes					Material			
	1.1	1.2	1.4	2.4	3.9				
	530 × 325 mm 20.8 × 12.7 in	325 × 265 mm 12.7 × 10.4 in	265 × 162 mm 10.4 × 6.3 in	530 × 162 mm 20.8 × 6.3 in	530 × 108 mm 20.8 × 4.2 in				
Tall Trays									
Trays									
Bread Boxes									
Lids									
Plinths									
Flat Frames									
Angled Frames									
Heating Unit									
Cooling Systems									

	Sizes		Material			
	Double	Compatible with 1.1				
Trolley / Hot and Cold Trolley						
Stands						
Assembly						



Flow Oak Trays

Craster is renowned for providing expertly-crafted, beautiful Flow trays using fine European oak, a classic material used worldwide.

Designed for quick changeover, each Flow gastronorm tray can be easily transferred from back-of-house and incorporated into Flow stands and trolleys as part of a display, or used alone for single-serve.



Flow Tall Oak 1.1 Tray

BU_FR006 •

Mat Oak, Oiled
Dim 530 × 325 × 75 mm
 20.8 × 12.7 × 2.9 in
MOQ 1
Note Compatible with all 1.1 products



Flow Oak 1.1 Tray

BU_FR001 •

Mat Oak, Oiled
Dim 530 × 325 × 40 mm
 20.8 × 12.7 × 1.5 in
MOQ 1
Note Compatible with all 1.1 products



Flow Tall Oak 1.2 Tray

BU_FR007 •

Mat Oak, Oiled
Dim 325 × 265 × 75 mm
 12.7 × 10.4 × 2.9 in
MOQ 1
Note Compatible with all 1.2 products



Flow Oak 1.2 Tray

BU_FR002 •

Mat Oak, Oiled
Dim 325 × 265 × 40 mm
 12.7 × 10.4 × 1.5 in
MOQ 1
Note Compatible with all 1.2 products



Flow Tall Oak 1.4 Tray

BU_FR008 •

Mat Oak, Oiled
Dim 265 × 162 × 75 mm
 10.4 × 6.3 × 2.9 in
MOQ 1



Flow Oak 1.4 Tray

BU_FR003 •

Mat Oak, Oiled
Dim 265 × 162 × 40 mm
 10.4 × 6.3 × 1.5 in
MOQ 1



Flow Tall Oak 2.4 Tray

BU_FR022 •

Mat Oak, Oiled
Dim 530 × 162 × 75 mm
 20.8 × 6.3 × 2.9 in
MOQ 1
Note Compatible with all 2.4 products



Flow Oak 2.4 Tray

BU_FR004 •

Mat Oak, Oiled
Dim 530 × 162 × 40 mm
 20.8 × 6.3 × 1.5 in
MOQ 1
Note Compatible with all 2.4 products



Flow Oak 3.9 Tray

BU_FR005

Mat Oak, Oiled
Dim 530 × 108 × 40 mm
 20.8 × 4.2 × 1.5 in
MOQ 1



Flow Oak Plinths and Stands

Flow Plinths and Stands rendered in fine oak add to the flexibility of the Flow Modular System.



Flow Oak 1.1 Crumb Catcher

BU_BR001 •
Mat Oak, Oiled
Dim 530 × 325 × 35 mm
 20.8 × 12.7 × 1.3 in
MOQ 1



Flow Oak 1.1 Plinth

BU_FT0035
Mat Oak, Oiled
Dim 530 × 325 × 20 mm
 20.8 × 12.7 × 0.7 in
MOQ 1
Note Compatible with all 1.1 products



Flow Oak 1.2 Plinth

BU_FT0036
Mat Oak, Oiled
Dim 265 × 325 × 20 mm
 10.4 × 12.8 × 0.7 in
MOQ 1
Note Compatible with all 1.2 products



Flow Oak 2.4 Plinth

BU_FT0037
Mat Oak, Oiled
Dim 530 × 162 × 20 mm
 20.8 × 6.3 × 0.7 in
MOQ 1
Note Compatible with all 2.4 products



Flow Five-Tier Oak Stand

BU_RS004
Mat Oak, Oiled
Dim 574 × 400 × 1459 mm
 22.6 × 15.7 × 57.4 in
MOQ 1
Note Includes 5 × BU_FR001 Trays
 Assembly required



Flow Four-Tier Oak Stand

BU_RS003
Mat Oak, Oiled
Dim 574 × 400 × 1197 mm
 22.6 × 15.7 × 47.1 in
MOQ 1
Note Includes 4 × BU_FR001 Trays
 Assembly required



Flow Oak 1.1 Two-Tier Stand

BU_RS002 •
Mat Oak, Oiled
Dim 574 × 323 × 441 mm
 22.6 × 12.7 × 17.4 in
MOQ 1
Note Includes 2 × BU_FR001 Trays
 Assembly required



Flow Oak 1.2 Two-Tier Stand

BU_RS001 •
Mat Oak, Oiled
Dim 309 × 323 × 441 mm
 12.1 × 9.1 × 17.4 in
MOQ 1
Note Includes 2 × BU_FR002 Trays
 Assembly required



Flow Walnut Trays, Plinths and Stands

The sumptuous grain of North American walnut has been a hallmark of fine dining institutions for centuries. Designed for quick changeover, each Flow gastronorm tray and plinth can be easily transferred from back-of-house and incorporated into Flow stands and trolleys as part of a display or used discretely for single-serve.



Flow Tall Walnut 1.1 Tray

BU_FF014 •
Mat Walnut, Lacquered
Dim 530 x 325 x 75 mm
 20.8 x 12.7 x 2.9 in
MOQ 1
Note Compatible with all 1.1 products



Flow Walnut 1.1 Tray

BU_FF011 •
Mat Walnut, Lacquered
Dim 530 x 325 x 40 mm
 20.8 x 12.7 x 1.5 in
MOQ 1
Note Compatible with all 1.1 products



Flow Tall Walnut 1.2 Tray

BU_FF015 •
Mat Walnut, Lacquered
Dim 325 x 265 x 75 mm
 12.7 x 10.4 x 2.9 in
MOQ 1
Note Compatible with all 1.2 products



Flow Walnut 1.2 Tray

BU_FF012 •
Mat Walnut, Lacquered
Dim 325 x 265 x 40 mm
 12.7 x 10.4 x 1.5 in
MOQ 1
Note Compatible with all 1.2 products



Flow Tall Walnut 1.4 Tray

BU_FF018
Mat Walnut, Lacquered
Dim 265 x 162 x 75 mm
 10.4 x 6.3 x 2.9 in
MOQ 1



Flow Walnut 1.4 Tray

BU_FF013
Mat Walnut, Lacquered
Dim 265 x 162 x 40 mm
 10.4 x 6.3 x 1.5 in
MOQ 1



Flow Walnut 2.4 Tray

BU_FF016
Mat Walnut, Lacquered
Dim 530 x 162 x 40 mm
 20.8 x 6.3 x 1.5 in
MOQ 1
Note Compatible with all 2.4 products



Flow Walnut 3.9 Tray

BU_FF017
Mat Walnut, Lacquered
Dim 530 x 108 x 40 mm
 20.8 x 4.2 x 1.5 in
MOQ 1



Flow Walnut 1.1 Plinth

BU_FT0030
Mat Walnut, Oiled
Dim 530 x 325 x 20 mm
 20.8 x 12.7 x 0.7 in
MOQ 1
Note Compatible with all 1.1 products



Flow Walnut 1.2 Plinth

BU_FT0031
Mat Walnut, Oiled
Dim 265 x 325 x 20 mm
 10.4 x 12.8 x 0.7 in
MOQ 1
Note Compatible with all 1.2 products



Flow Walnut 2.4 Plinth

BU_FT0032
Mat Walnut, Oiled
Dim 530 x 162 x 20 mm
 20.8 x 6.3 x 0.7 in
MOQ 1
Note Compatible with all 2.4 products



Flow Walnut 1.1 Two-Tier Stand

BU_RS012 •
Mat Walnut, Lacquered
Dim 574 x 323 x 441 mm
 22.6 x 12.7 x 17.4 in
MOQ 1
Note Includes 2 x BU_FF011 Trays
 Assembly required



Flow Walnut 1.2 Two-Tier Stand

BU_RS011
Mat Walnut, Lacquered
Dim 309 x 323 x 441 mm
 12.1 x 9.1 x 17.4 in
MOQ 1
Note Includes 2 x BU_FF012 Trays
 Assembly required

Flow Bento System

Curate delightful dining experiences with modular Stacking Bento Boxes for meal and drink delivery without single-use plastics. These boxes consolidate cuisine presentations for covered transport to Bali beds, party villas, or poolside loungers.

Flow trays offer a sustainable solution, shifting easily from Bento arrangements to full buffet setups with frames, trolleys, and stands.



Flow Bento Kit 1.1 Meal

SET_BBWLM
Mat Walnut, Lacquered
Dim 530 x 325 x 230 mm
 20.8 x 12.8 x 9 in
MOQ 1
Note Components: 1 x BU_FF061, 1 x BU_FC061, 1 x BU_FF062, 2 x BU_FF066



Flow Bento Kit 1.2 Small Meal

SET_BBWSM
Mat Walnut, Lacquered
Dim 325 x 265 x 230 mm
 12.8 x 10.4 x 9 in
MOQ 1
Note Components: 1 x BU_FF062, 2 x BU_FF066, 1 x BU_FC062



Flow 1.1 Bento Tray Lid

BU_FC061
Mat Walnut, Lacquered
BU_FC051
Mat Oak, Lacquered
Dim 530 x 325 x 20 mm
 20.8 x 12.8 x 0.8 in
MOQ 1
Note Compatible with all 1.1 trays



Flow 1.2 Bento Tray Lid

BU_FC062
Mat Walnut, Lacquered
BU_FC052
Mat Oak, Lacquered
Dim 325 x 265 x 20 mm
 12.8 x 10.4 x 0.8 in
MOQ 1
Note Compatible with all 1.2 trays



Flow 1.8 Bento Tray Lid

BU_FC066
Mat Walnut, Lacquered
BU_FC056
Mat Oak, Lacquered
Dim 325 x 132 x 20 mm
 12.8 x 5.2 x 0.8 in
MOQ 1
Note Compatible with all 1.8 trays

Flow Bento System

Mix lids and drop-in internal dividers to craft your Bento solution using Flow 1.1 and 1.2 gastronorm trays.

Stacking Bento Box components integrate seamlessly into the Flow system, with bespoke designs available on request.



Watch the video



Flow 1.1 Bento Tray

BU_FF061
Mat Walnut, Lacquered
BU_FF051
Mat Oak, Lacquered
Dim 530 x 325 x 110 mm
 20.8 x 12.8 x 4.3 in
Int 504 x 299 x 90 mm
 19.8 x 11.8 x 3.5 in
MOQ 1
Note Compatible with all 1.1 products

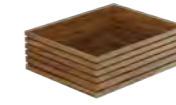

Flow 1.2 Bento Tray

BU_FF062
Mat Walnut, Lacquered
BU_FF052
Mat Oak, Lacquered
Dim 325 x 265 x 110 mm
 12.8 x 10.4 x 4.3 in
Int 299 x 239 x 90 mm
 11.8 x 9.4 x 3.5 in
MOQ 1
Note Compatible with all 1.2 products



Flow 1.8 Bento Tray

BU_FF066
Mat Walnut, Lacquered
BU_FF056
Mat Oak, Lacquered
Dim 325 x 132 x 110 mm
 12.8 x 5.2 x 4.3 in
Int 299 x 105 x 90 mm
 11.8 x 4.1 x 3.5 in
MOQ 1
Note Compatible with all 1.8 products



Flow 1.1 Grey Bento Lid

BU_BL011
Mat Grey Acrylic
Dim 310 x 515 x 4 mm
 12.2 x 20.3 x 0.2 in
MOQ 1
Note Compatible with all Flow 1.1 Trays



Flow 1.2 Grey Bento Lid

BU_BL012
Mat Grey Acrylic
Dim 250 x 310 x 4 mm
 9.8 x 12.2 x 0.2 in
MOQ 1
Note Compatible with all Flow 1.2 Trays



Flow 1.1 Black Bento Divider

BU_BD011
Mat Black, Lacquered
Dim 297 x 502 x 54 mm
 11.7 x 19.8 x 2.1 in
MOQ 1
Note Compatible with all Flow Tall 1.1 Trays



Flow 1.2 Black Bento Divider

BU_BD021
Mat Black, Lacquered
Dim 237 x 297 x 54 mm
 9.3 x 11.7 x 2.1 in
MOQ 1
Note Compatible with all Flow Tall 1.2 Trays



Flow Whitewashed Trays and Stands

Illuminating and clarifying, whitewashed ash Flow is perfect for an airy country brunch or summer setting.

Designed for quick changeover, each Flow gastronorm tray can be easily transferred from back-of-house and incorporated into whitewashed ash Flow stands.



Flow Tall White 1.1 Tray

BU_FR046

Mat Whitewashed, Lacquered
Dim 530 x 325 x 75 mm
 20.8 x 12.7 x 2.9 in
MOQ 1
Note Compatible with all 1.1 products



Flow White 1.1 Tray

BU_FR041

Mat Whitewashed, Lacquered
Dim 530 x 325 x 40 mm
 20.8 x 12.7 x 1.5 in
MOQ 1
Note Compatible with all 1.1 products



Flow Tall White 1.2 Tray

BU_FR047

Mat Whitewashed, Lacquered
Dim 325 x 265 x 75 mm
 12.7 x 10.4 x 2.9 in
MOQ 1
Note Compatible with all 1.2 products



Flow White 1.2 Tray

BU_FR042

Mat Whitewashed, Lacquered
Dim 325 x 265 x 40 mm
 12.7 x 10.4 x 1.5 in
MOQ 1
Note Compatible with all 1.2 products



Flow White 2.4 Tray

BU_FR044

Mat Whitewashed, Lacquered
Dim 530 x 162 x 40 mm
 20.8 x 6.3 x 1.5 in
MOQ 1
Note Compatible with all 2.4 products



Flow White 1.1 Two-Tier Stand

BU_RS042

Mat Whitewashed, Lacquered
Dim 574 x 323 x 441 mm
 22.6 x 12.7 x 17.4 in
MOQ 1
Note Includes 2 x BU_FR041 Trays
 Assembly required



Flow White 1.2 Two-Tier Stand

BU_RS041

Mat Whitewashed, Lacquered
Dim 309 x 323 x 441 mm
 12.1 x 9.1 x 17.4 in
MOQ 1
Note Includes 2 x BU_FR042 Trays
 Assembly required



Flow Black Trays and Stands

Elegant and timeless, black lacquered ash Flow items are the perfect addition to elegant gastronomic presentations. Designed for quick changeover, each Flow gastronomic tray can be easily transferred from back-of-house and incorporated into black lacquered Flow stands.



Flow Tall Black 1.1 Tray

BU_FR036

Mat Black, Lacquered
Dim 530 × 325 × 75 mm
 20.8 × 12.7 × 2.9 in
MOQ 1
Note Compatible with all 1.1 products



Flow Black 1.1 Tray

BU_FR031

Mat Black, Lacquered
Dim 530 × 325 × 40 mm
 20.8 × 12.7 × 1.5 in
MOQ 1
Note Compatible with all 1.1 products



Flow Tall Black 1.2 Tray

BU_FR037 •

Mat Black, Lacquered
Dim 325 × 265 × 75 mm
 12.7 × 10.4 × 2.9 in
MOQ 1
Note Compatible with all 1.2 products



Flow Black 1.2 Tray

BU_FR032

Mat Black, Lacquered
Dim 325 × 265 × 40 mm
 12.7 × 10.4 × 1.5 in
MOQ 1
Note Compatible with all 1.2 products



Flow Tall Black 1.4 Tray

BU_FR038

Mat Black, Lacquered
Dim 265 × 162 × 75 mm
 10.4 × 6.3 × 2.9 in
MOQ 1



Flow Black 2.4 Tray

BU_FR034

Mat Black, Lacquered
Dim 530 × 162 × 40 mm
 20.8 × 6.3 × 1.5 in
MOQ 1
Note Compatible with all 2.4 products



Flow Black 1.1 Two-Tier Stand

BU_RS032

Mat Black, Lacquered
Dim 574 × 323 × 441 mm
 22.6 × 12.7 × 17.4 in
MOQ 1
Note Includes 2 × BU_FR031 Trays
 Assembly required



Flow Black 1.2 Two-Tier Stand

BU_RS031

Mat Black, Lacquered
Dim 309 × 323 × 441 mm
 12.1 × 9.1 × 17.4 in
MOQ 1
Note Includes 2 × BU_FR032 Trays
 Assembly required



Flow Bread Display

A stunning addition to the gastronorm Flow system, the Bread Box is available for covered, hygienic presentation of bread and baked goods for large buffets and displays.

Available in 1.1 and 1.3 sizes, the Bread Box integrates seamlessly into Flow buffet setups.

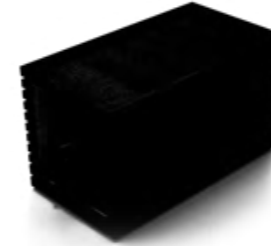

Flow Oak Single Bread Box

BU_BD10NL •

Mat Oak, Lacquered and Acrylic
Dim 349 × 176 × 190mm
 13.7 × 6.9 × 7.4 in
MOQ 1



Flow Walnut Single Bread Box

BU_BD1WNL

Mat Walnut, Lacquered and Acrylic
Dim 349 × 176 × 190mm
 13.7 × 6.9 × 7.4 in
MOQ 1



Flow Oak Triple Bread Box

BU_BD30NL •

Mat Oak, Lacquered and Acrylic
Dim 349 × 530 × 190mm
 13.7 × 20.9 × 7.4 in
MOQ 1



Flow Walnut Triple Bread Box

BU_BD3WNL

Mat Walnut, Lacquered and Acrylic
Dim 349 × 530 × 190mm
 13.7 × 20.9 × 7.4 in
MOQ 1

Flow Sliding Lid

Designed for intuitive use, the Flow Sliding Lid provides a sleek aesthetic alternative to standard gastronorm lift-up lids and is ideal for covered food presentation as part of a large display or single-serve. The lid has been carefully designed for single-handed use, providing easy access and a smooth self-service experience.

The Flow Sliding Lid is compatible with 1.1 Flow trays.



Flow Sliding Lid

BU_SL002 •

Mat Clear Acrylic
Dim **Open:** 526 × 335 × 96 mm
 20.7 × 13.2 × 3.8 in
Closed: 300 × 335 × 96 mm
 11.8 × 13.2 × 3.8 in
MOQ 1

Flow Tritan Lid Liner

Designed to offer a contemporary, glass-like covered solution, the new Flow Tritan Lid Liner offers a premium guest experience for covered food presentation and wet food display in a dishwasher-safe and BPA-free material.

Flow Lid Liners can be used as a lid or a liner, enabling Flow trays to hold fresh ice for drinks or yogurt pots, or to transform trays into covered cuisine solutions. The Flow Tritan lid liner is compatible with 1.1 Tall and 1.2 Tall Flow trays as both a lid and a liner. Use with 1.1 and 1.2 Low trays as a lid only.

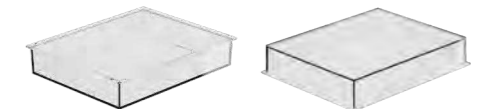
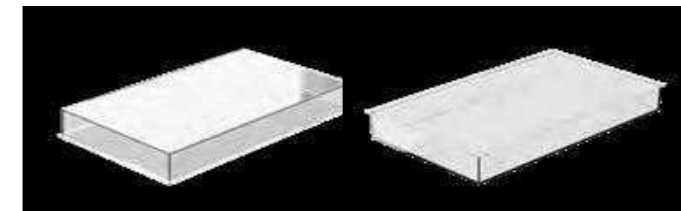

Flow Tritan Lid Liner 1.1

BU_LL1121 •

Mat Tritan (BPA-free plastic)
Dim 310 × 515 × 53 mm
 12.2 × 20.3 × 2 in
Note Compatible with 1.1 trays (as a lid)
 Tall 1.1 trays (as a liner)
MOQ 1

Flow Tritan Lid Liner 1.2

BU_LL1221

Mat Tritan (BPA-free plastic)
Dim 250 × 310 × 53 mm
 9.8 × 12.2 × 2 in
MOQ 1
Note Compatible with 2 1.1 and 1.2 trays (as a lid)
 Tall 1.1 and 1.2 trays (as a liner)



Flow Heating Unit

The Flow Heating Unit is ideal for keeping food hot while on display, utilising ceramic heating element technology and offering an easily adjustable variable temperature control up to 140°C (284°F).

With a solid black lacquered, natural oak, or walnut base and slate-like composite surface, the Flow Heating Unit offers a unique aesthetic solution to keeping food warm. Compatible with 1.1 Flow frames.



Flow Oak Heating Unit

BU_FH2101

Note UK Plug, cable included

BU_FH2102

Note EU Type F Plug, cable included

BU_FH2104

Note US Plug, cable included

Mat Oak, Dekton

Dim 530 x 325 x 61 mm
20.8 x 12.8 x 2.4 in

MOQ 1



Flow Walnut Heating Unit

BU_FH2201

Note UK Plug, cable included

BU_FH2202

Note EU Type F Plug, cable included

BU_FH2204

Note US Plug, cable included

Mat Walnut, Dekton

Dim 530 x 325 x 61 mm
20.8 x 12.8 x 2.4 in

MOQ 1



Flow Black Heating Unit

BU_FH2301

Note UK Plug, cable included

BU_FH2302

Note EU Type F Plug, cable included

BU_FH2304

Note US Plug, cable included

Mat Black Lacquered, Dekton

Dim 530 x 325 x 61 mm
20.8 x 12.8 x 2.4 in

MOQ 1





Flow Cooling Trays

The Flow Cold Cell Cooling Trays allow for elegant display of chilled gastronomy. Offering exceptional cooling performance over previous models, the new cold cell technology enables the food-safe slate presentation area to hold a temperature below 8°C (46°F) for up to four hours.

Available in whitewashed, black lacquered, natural oak, or natural walnut, the Flow Cold Cell Cooling Trays are compatible with 1.1 and 1.2 Flow frames.



Flow Oak 1.2 Cold Cell Cooling Tray

BU_FR0012

Mat Oak, Oiled
Dim 325 × 265 × 75 mm
12.8 × 10.4 × 3 in
MOQ 1

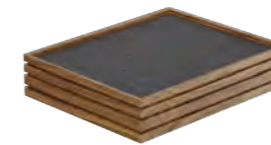

Flow Walnut 1.2 Cold Cell Cooling Tray

BU_FF1012

Mat Walnut, Lacquered
Dim 325 × 265 × 75 mm
12.8 × 10.4 × 3 in
MOQ 1

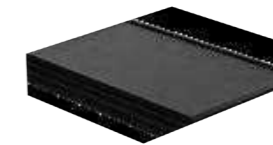

Flow White 1.2 Cold Cell Cooling Tray

BU_FR4012

Mat Whitewashed, Lacquered
Dim 325 × 265 × 75 mm
12.8 × 10.4 × 3 in
MOQ 1

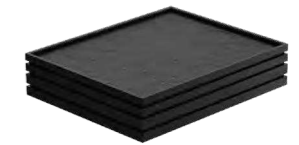

Flow Black 1.2 Cold Cell Cooling Tray

BU_FR3012

Mat Black, Lacquered
Dim 325 × 265 × 75 mm
12.8 × 10.4 × 3 in
MOQ 1



Flow Oak 1.1 Cold Cell Cooling Tray

BU_FR0011

Mat Oak, Oiled
Dim 530 × 325 × 75 mm
20.8 × 12.7 × 3 in
MOQ 1

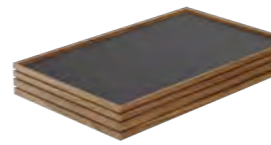

Flow Walnut 1.1 Cold Cell Cooling Tray

BU_FF1011

Mat Walnut, Lacquered
Dim 530 × 325 × 75 mm
20.8 × 12.7 × 3 in
MOQ 1



Flow White 1.1 Cold Cell Cooling Tray

BU_FR4011

Mat Whitewashed, Lacquered
Dim 530 × 325 × 75 mm
20.8 × 12.7 × 3 in
MOQ 1



Flow Black 1.1 Cold Cell Cooling Tray

BU_FR3011

Mat Black, Lacquered
Dim 530 × 325 × 75 mm
20.8 × 12.7 × 3 in
MOQ 1



Flow 1.2 Low Slate Insert

BU_FTL050

Mat Slate
Dim 298 × 238 × 6 mm
11.7 × 9.4 × 0.2 in
MOQ 1

Flow 1.2 Cold Cell and Tray Liner Set

SET_CCCL

Mat Aluminium and Expanded Polypropylene
Dim 295 × 235 × 48 mm
10.2 × 7.9 × 1.7 in
MOQ 1





Flow Glass and Marble Plinths

Flow Plinths are available in minimalist clear or smoked grey glass and luxurious white, green, or grey marble. Glass plinths are compatible with 1.1, 1.2, and 2.4 Flow frames. Marble plinths are compatible with 1.2 and 2.4 Flow frames.



Flow Glass 1.1 Plinth

BU_FT0010
Mat Glass, Clear
 BU_FT0040
Mat Glass, Black
Dim 530 x 325 x 20 mm
 20.8 x 12.7 x 0.7 in
MOQ 1
Note Compatible with all 1.1 products



Flow Glass 1.2 Plinth

BU_FT0012
Mat Glass, Clear
 BU_FT0042
Mat Glass, Black
Dim 265 x 325 x 20 mm
 10.4 x 12.8 x 0.7 in
MOQ 1
Note Compatible with all 1.2 products

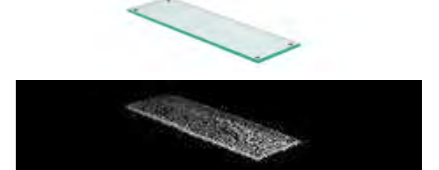

Flow Glass 2.4 Plinth

BU_FT0011
Mat Glass, Clear
 BU_FT0041
Mat Glass, Black
Dim 530 x 162 x 20 mm
 20.8 x 6.3 x 0.7 in
MOQ 1
Note Compatible with all 2.4 products

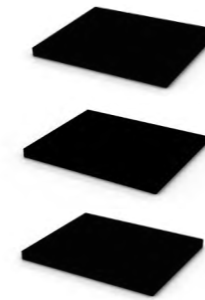

Flow Marble 1.2 Plinth

BU_FT0022 •
Mat Marble, White
 BU_FT0062
Mat Marble, Grey
Dim 265 x 325 x 20 mm
 10.4 x 12.8 x 0.7 in
MOQ 1
Note Compatible with all 1.2 frames
 BU_FT0072
Mat Marble, Verde Guatemala
Dim 265 x 325 x 20 mm
 10.4 x 12.8 x 0.7 in
MOQ 1
Note Compatible with all 1.2 frames



Flow Marble 2.4 Plinth

BU_FT0020 •
Mat Marble, White
 BU_FT0060 •
Mat Marble, Grey
Dim 530 x 162 x 20 mm
 20.8 x 6.3 x 0.7 in
MOQ 1
Note Compatible with all 2.4 frames
 BU_FT0070
Mat Marble, Verde Guatemala
Dim 530 x 162 x 20 mm
 20.8 x 6.3 x 0.7 in
MOQ 1
Note Compatible with all 2.4 frames



Flow Frames

Flow Frames are available in stainless steel with brass PVD, black powder-coated, or brushed stainless finishes. Designed to work with all Flow trays and plinths, they offer both flat and angled display options—ideal for creating dynamic, layered presentations.



Flow Tall Flat 1.1 Frame

BU_FL001 •
Mat Stainless Steel
BU_FL021 •
Mat Powder Coated Steel, Black
BU_FL031 •
Mat Stainless Steel, Brass PVD
Dim 530 × 325 × 184 mm
 20.9 × 12.8 × 7.2 in
MOQ 1

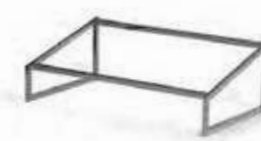

Flow Tall Angled 1.1 Frame

BU_FL003
Mat Stainless Steel
BU_FL023 •
Mat Powder Coated Steel, Black
Dim 530 × 315 × 182 mm
 20.9 × 12.4 × 7.1 in
MOQ 1



Flow Low Flat 1.1 Frame

BU_FL002 •
Mat Stainless Steel
BU_FL022 •
Mat Powder Coated Steel, Black
BU_FL032
Mat Stainless Steel, Brass PVD
Dim 530 × 325 × 99 mm
 20.9 × 12.8 × 3.9 in
MOQ 1



Flow Low Angled 1.1 Frame

BU_FL004 •
Mat Stainless Steel
BU_FL024
Mat Powder Coated Steel, Black
Dim 530 × 315 × 97 mm
 20.9 × 12.4 × 3.8 in
MOQ 1



Flow Tall Flat 1.2 Frame

BU_FL005 •
Mat Stainless Steel
BU_FL025 •
Mat Powder Coated Steel, Black
BU_FL035 •
Mat Stainless Steel, Brass PVD
Dim 265 × 325 × 184 mm
 10.4 × 12.8 × 7.2 in
MOQ 1

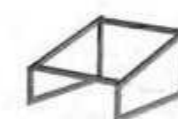

Flow Tall Angled 1.2 Frame

BU_FL007 •
Mat Stainless Steel
BU_FL027
Mat Powder Coated Steel, Black
Dim 265 × 315 × 182 mm
 10.4 × 12.4 × 7.1 in
MOQ 1



Flow Low Flat 1.2 Frame

BU_FL006 •
Mat Stainless Steel
BU_FL026 •
Mat Powder Coated Steel, Black
BU_FL036 •
Mat Stainless Steel, Brass PVD
Dim 265 × 325 × 99 mm
 10.4 × 12.8 × 3.9 in
MOQ 1



Flow Low Angled 1.2 Frame

BU_FL008 •
Mat Stainless Steel
BU_FL028 •
Mat Powder Coated Steel, Black
Dim 265 × 315 × 97 mm
 10.4 × 12.4 × 3.8 in
MOQ 1



Flow Tall Flat 2.4 Frame

BU_FL009 •
Mat Stainless Steel
Dim 530 × 163 × 184 mm
 20.9 × 6.4 × 7.2 in
MOQ 1

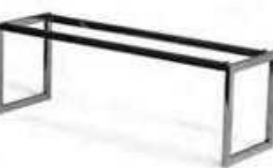

Flow Low Flat 2.4 Frame

BU_FL029 •
Mat Powder Coated Steel, Black

BU_FL039 •
Mat Stainless Steel, Brass PVD

BU_FL010 •
Mat Stainless Steel
Dim 530 × 163 × 99 mm
 20.9 × 6.4 × 3.9 in
MOQ 1

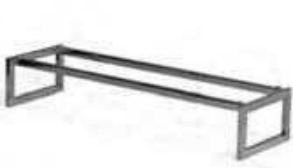

BU_FL030 •
Mat Powder Coated Steel, Black

BU_FL040 •
Mat Stainless Steel, Brass PVD

Materials and Colours



Stainless Steel



Powder Coated Steel, Black



Stainless Steel, Brass PVD



Flow Label Holders

Add functionality to your display with labelling. Flow Label Holders slot easily onto the edge of Flow trays and stands or can be used as stand-alone products.



Flow Brass Label Holder

BU_LH002 •

Mat Brushed Brass
Dim 30ø x 38 mm
 1.18ø x 1.10 in
MOQ 1
Note Compatible with all Flow trays



Flow Stainless Steel Label Holder

BU_LH004 •

Mat Brushed Stainless Steel
Dim 30ø x 38 mm
 1.18ø x 1.10 in
MOQ 1
Note Compatible with all Flow trays



Flow Copper Label Holder

BU_LH006

Mat Copper PVD and Stainless Steel
Dim 30ø x 38 mm
 1.18ø x 1.10 in
MOQ 1
Note Compatible with all Flow trays



Flow Trolleys

Flow Trolleys have been specified by the Craster design team to offer complete display flexibility. With multiple extending shelves and folding platforms, each trolley offers an adaptable solution for both single and double-sided service for action stations or grab-and-go displays.

Flow's interchangeable and stackable components offer versatility to tailor gastronomic display and allow for efficient replenishment between front and back-of-house.



Flow Oak Double Trolley

TO_RS101

Mat Oak, Lacquered

Dim Open:	1694 × 1082 × 960 mm	Closed:	1356 × 700 × 960 mm
	66.7 × 42.6 × 37.8 in		53.4 × 27.6 × 37.8 in

MOQ 1

Note Maximum Load: 20kg per shelf, 10kg per flap



Flow Oak Single Trolley

TO_RS102

Mat Oak, Lacquered

Dim Open:	1159 × 1082 × 960 mm	Closed:	821 × 700 × 960 mm
	45.6 × 42.6 × 37.8 in		32.3 × 27.6 × 37.8 in

MOQ 1

Note Maximum Load: 20kg per shelf, 10kg per flap



Flow Walnut Double Trolley

TO_RS103

Mat Walnut, Lacquered

Dim Open:	1694 × 1082 × 960 mm	Closed:	1356 × 700 × 960 mm
	66.7 × 42.6 × 37.8 in		53.4 × 27.6 × 37.8 in

MOQ 1

Note Maximum Load: 20kg per shelf, 10kg per flap



Flow Walnut Single Trolley

TO_RS104

Mat Walnut, Lacquered

Dim Open:	1159 × 1082 × 960 mm	Closed:	821 × 700 × 960 mm
	45.6 × 42.6 × 37.8 in		32.3 × 27.6 × 37.8 in

MOQ 1

Note Maximum Load: 20kg per shelf, 10kg per flap



Flow Hot and Cold Trolleys

Flow Hot and Cold Trolleys deliver dual cooling and heating functionality in one compact, versatile display unit, enabling functional flexibility from chilled breakfast juice stations to heated brunch action stations and frosted grab-and-go cuisine presentation.

Specified by the Craster design team to withstand temperature changes, the food-safe, durable top offers a wide temperature range from -5°C (23°F) to 140°C (284°F). The trolley features multiple extending shelves, giving added storage for multi-height display with double-sided service.



Flow Oak Hot and Cold Trolley

TO_HC2101

Plug UK Plug

TO_HC2102

Plug EU Type F Plug

TO_HC2104

Plug US Plug

Mat Oak, Lacquered and Dekton

Dim Open:	Closed:
1489 x 1082 x 960 mm	829 x 700 x 960 mm
58.6 x 42.6 x 37.8 in	32.6 x 27.6 x 37.8 in

MOQ 1

Note Maximum Load: 20kg per shelf, 10kg per flap
Variable Temperature from -5°C to +140°C



Flow Walnut Hot and Cold Trolley

TO_HC2201

Plug UK Plug

TO_HC2202

Plug EU Type F Plug

TO_HC2204

Plug US Plug

Mat Walnut, Lacquered and Dekton

Dim Open:	Closed:
1489 x 1082 x 960 mm	829 x 700 x 960 mm
58.6 x 42.6 x 37.8 in	32.6 x 27.6 x 37.8 in

MOQ 1

Note Maximum Load: 20kg per shelf, 10kg per flap
Variable Temperature from -5°C to +140°C





Flow Oak Troughs

Designed and developed to offer the Flow range greater volume capacity, Flow Oak Troughs are ideal for bottle services. Trough liners enable easy replenishment and can extend the lifetime of the oak.



Flow Tall Oak Trough

BU_RS005
Mat Oak, Lacquered
Dim 574 x 250 x 857 mm
 22.6 x 9.8 x 33.7 in
MOQ 1
Note Includes: BU_RS009 & BU_RS007
 Assembly required



Flow Oak Trough

BU_RS006
Mat Oak, Lacquered
Dim 574 x 250 x 432 mm
 22.6 x 9.8 x 17 in
MOQ 1
Note Includes: BU_RS009
 Assembly required



Flow Tall Oak Trough Tray

BU_RS009
Mat Oak, Lacquered
Dim 530 x 250 x 200 mm
 20.9 x 9.8 x 7.9 in
MOQ 1



Flow Oak Trough Tray

BU_RS007
Mat Oak, Lacquered
Dim 530 x 250 x 160 mm
 20.9 x 9.8 x 6.3 in
MOQ 1



Flow Oak Half Trough Tray

BU_RS008
Mat Oak, Lacquered
Dim 265 x 250 x 160 mm
 10.4 x 9.8 x 6.3 in
MOQ 1



Flow Half Trough Liner

BU_TL1321
Mat Transparent PETG
Dim 250 x 235 x 128 mm
 9.8 x 9.2 x 5 in
MOQ 1
Note 2 Units required for use with Flow Trough Tray



Tilt

Frame finishes: Black (powder coated steel), stainless steel, brass.

Practical: Cylindrical metal frames support diverse serving tops, and frames are secured by precision-fitted rubber rings for stability.

Bowl finishes: Brass, copper, walnut, olive wood. Ceramic in white, black, light grey, and dark grey.

Plinth finishes: Oak, walnut, black glass, grey marble, white marble, green marble.

Other accessories: Yoghurt dispenser, juice dispenser, mini juice dispenser, jars and lids, spoons.

FRAME SIZES:

Tilt Standard: Low, medium, tall, and extra tall.

Tilt Large: Low, medium, and tall.

Tilt Mini: Single, triple, and quintuple variations (in low and medium heights).

Ideal for:

Creative displays, multi-height buffet setups, coffee stations.



Discover more

How to Create Your Buffet with Tilt

Tilt is a flexible system composed of cylindrical metal frames compatible with serving top solutions for both wet and dry foods as part of a large display or in single-serve presentations.

To create a custom display, choose a frame diameter and height. Then pair it with bowls, plinths, or juice dispensers crafted from luxurious marble, black glass, stainless steel, or solid wood. For a seamless setup, ensure that your selected display vessel is compatible with your frame's diameter.

	Sizes	Material
Bowls and Platters		<ul style="list-style-type: none"> Oak Walnut Olive Wood Brass PVD and Steel Copper PVD and Steel Black Porcelain Dark Grey Porcelain Light Grey Porcelain White Porcelain Bone China
Glass Jars		<ul style="list-style-type: none"> Clear Glass
Juice Dispensers		<ul style="list-style-type: none"> Clear Glass
Tilt Large - XL Plinths		<ul style="list-style-type: none"> Oak Walnut White Marble Black Marble Black Glass Green Marble <p><small>*Any XL sizes fit on standard frames and large frames *XL Plinth only available in oak and walnut</small></p>
Tilt Standard Plinths		<ul style="list-style-type: none"> Oak Walnut White Marble Black Marble Black Glass Green Marble
Tilt Mini Plinths		<ul style="list-style-type: none"> Oak Walnut White Marble Grey Marble
Tilt Utensils		<ul style="list-style-type: none"> Oak Walnut

	Sizes	Material
Tilt Large Frames (ø 320 mm / 12.6 in)		<ul style="list-style-type: none"> Powder-coated Black
Tilt Standard Frames (ø 218 mm / 8.6 in)		<ul style="list-style-type: none"> Steel Powder-coated Black Brass PVD and Steel
Tilt Mini Frames (ø 125 mm / 4.9 in)		<ul style="list-style-type: none"> Steel Powder-coated Black
Tilt Yoghurt Dispenser		<ul style="list-style-type: none"> Stainless Steel + White
Tilt Utensils		<ul style="list-style-type: none"> Oak Walnut



Tilt Porcelain Bowls

Tilt bowls are intelligently engineered to fit seamlessly within Tilt frames, with an ability to be tilted at various angles to enhance food volume.

Porcelain bowls are perfect for cereal and salad presentation.



Tilt Black Porcelain Bowl

Large	Medium	Small
BW_CR1801 •	BW_CR1802 •	BW_CR1803 •
Mat Porcelain	Porcelain	Porcelain
Dim 290ø × 100 mm 11.4ø × 3.9 in	250ø × 85 mm 9.8ø × 3.3 in	210ø × 70 mm 8.3ø × 2.8 in
Vol 3.5 litres Approx. 123 fl oz	2 litres Approx. 44 fl oz	1 litre Approx. 35 fl oz
MOQ 1	1	1



Tilt Dark Grey Porcelain Bowl

Large	Medium	Small
BW_CR1501 •	BW_CR1502 •	BW_CR1503 •
Mat Porcelain	Porcelain	Porcelain
Dim 290ø × 100 mm 11.4ø × 3.9 in	250ø × 85 mm 9.8ø × 3.3 in	210ø × 70 mm 8.3ø × 2.8 in
Vol 3.5 litres Approx. 123 fl oz	2 litres Approx. 44 fl oz	1 litre Approx. 35 fl oz
MOQ 1	1	1



Tilt Light Grey Porcelain Bowl

Large	Medium	Small
BW_CR1601 •	BW_CR1602 •	BW_CR1603 •
Mat Porcelain	Porcelain	Porcelain
Dim 290ø × 100 mm 11.4ø × 3.9 in	250ø × 85 mm 9.8ø × 3.3 in	210ø × 70 mm 8.3ø × 2.8 in
Vol 3.5 litres Approx. 123 fl oz	2 litres Approx. 44 fl oz	1 litre Approx. 35 fl oz
MOQ 1	1	1



Tilt White Porcelain Bowl

Large	Medium	Small
BW_CR1701 •	BW_CR1702 •	BW_CR1703 •
Mat Porcelain	Porcelain	Porcelain
Dim 290ø × 100 mm 11.4ø × 3.9 in	250ø × 85 mm 9.8ø × 3.3 in	210ø × 70 mm 8.3ø × 2.8 in
Vol 3.5 litres Approx. 123 fl oz	2 litres Approx. 44 fl oz	1 litre Approx. 35 fl oz
MOQ 1	1	1



Tilt Porcelain Platters

With a gentle hemispherical curve, Tilt Porcelain Platters enhance food presentation—especially salads—creating volume and visual impact with less product.

Available in white, grey, and dark grey, the colours match our bestselling Tilt Bowls and offer flexibility for buffet display. Darker tones highlight vibrant ingredients and help paler foods stand out. Made from high-fired porcelain, the platters are durable and dishwasher safe for everyday professional use.



Tilt Large Dark Grey Porcelain Platter

BW_PP1501

Mat Porcelain
Dim 340ø × 47mm
 13.4 × 13.4 × 1.9 in
MOQ 1



Tilt Large Light Grey Porcelain Platter

BW_PP1601

Mat Porcelain
Dim 340ø × 47mm
 13.4 × 13.4 × 1.9 in
MOQ 1



Tilt Large White Porcelain Platter

BW_PP1701

Mat Porcelain
Dim 340ø × 47mm
 13.4 × 13.4 × 1.9 in
MOQ 1



Tilt Brass and Copper Bowls

Tilt bowls are intelligently engineered to fit seamlessly within Tilt frames, with an ability to be tilted at various angles to enhance food volume.

Tilt Brass and Copper Bowls are ideal for wet food display.



Tilt Brass Bowl

Large BW_BR1903 •

Mat Brass PVD and
Stainless Steel

Dim 285ø × 100 mm
11.2ø × 3.9 in

Vol 4.1 litres
Approx. 144 fl oz

MOQ 1

Medium BW_BR1902 •

Mat Brass PVD and
Stainless Steel

Dim 250ø × 85 mm
9.8ø × 3.3 in

Vol 2.5 litres
Approx. 88 fl oz

MOQ 1

Small BW_BR1901 •

Mat Brass PVD and
Stainless Steel

Dim 215ø × 70 mm
8.5ø × 2.7 in

Vol 1.5 litres
Approx. 53 fl oz

MOQ 1



Tilt Copper Bowl

Large BW_CO1903 •

Mat Copper PVD and
Stainless Steel

Dim 285ø × 100 mm
11.2ø × 3.9 in

Vol 4.1 litres
Approx. 144 fl oz

MOQ 1

Medium BW_CO1902 •

Mat Copper PVD and
Stainless Steel

Dim 250ø × 85 mm
9.8ø × 3.3 in

Vol 2.5 litres
Approx. 88 fl oz

MOQ 1

Small BW_CO1901 •

Mat Copper PVD and
Stainless Steel

Dim 215ø × 70 mm
8.5ø × 2.7 in

Vol 1.5 litres
Approx. 53 fl oz

MOQ 1





Tilt Fine Bone China Coupes

The Tilt Fine Bone China Coupes are ideal for large-scale presentation.

Designed for effortless single-handed self-service in luxury buffet settings, this collection combines elegant curves with versatile shapes to enhance table presentation.

The Tilt Bone China Coupe Bowl and Platter are compatible with both Tilt Mini frames and standard Tilt frames.

The Tilt Large Bone China Coupe Bowl and Platter are compatible only with Tilt Large frames and standard Tilt frames.



Tilt Coupe Large Bowl

BW_BC004

Mat Fine Bone China
Dim 364ø × 88 mm
 14.33 × 14.33 × 3.46 in
Vol 71 litres
 Approx. 240 fl oz
MOQ 1



Tilt Coupe Bowl

BW_BC002

Mat Fine Bone China
Dim 262ø × 88 mm
 10.31 × 10.31 × 3.46 in
Vol 3.4 litres
 Approx. 114 fl oz
MOQ 1



Tilt Coupe Large Platter

BW_BC003

Mat Fine Bone China
Dim 364ø × 46 mm
 14.33 × 14.33 × 1.81 in
Vol 3.4 litres
 Approx. 114 fl oz
MOQ 1



Tilt Coupe Platter

BW_BC001

Mat Fine Bone China
Dim 262ø × 46 mm
 10.31 × 10.31 × 1.81 in
Vol 1.6 litres
 Approx. 54 fl oz
MOQ 1





Tilt Olive Wood Bowls

Beautifully handcrafted from solid olive wood, each piece in this collection showcases the rich, natural grain of the timber. Ideal for displaying fresh produce, these rustic bowls and platters bring organic warmth and character to any setting.

Due to the natural variation in grain and the artisanal process, each item is unique—subtle differences in size and finish are to be expected.



Large Rustic Olive Wood Bowl

BW_OR2103

Mat Olive Wood, Oiled
Dim 290ø × 100 mm
 1.4ø × 3.9 in

MOQ 1

Note Due to the natural variations in olive wood, bowl sizes may vary significantly and exact dimensions cannot be guaranteed.



Medium Rustic Olive Wood Bowl

BW_OR2102

Mat Olive Wood, Oiled
Dim 250ø × 85 mm
 9.8ø × 3.3 in

MOQ 1

Note Due to the natural variations in olive wood, bowl sizes may vary significantly and exact dimensions cannot be guaranteed.



Small Rustic Olive Wood Bowl

BW_OR2101

Mat Olive Wood, Oiled
Dim 210ø × 70 mm
 8.3ø × 2.8 in

MOQ 1

Note Due to the natural variations in olive wood, bowl sizes may vary significantly and exact dimensions cannot be guaranteed.



Mini Rustic Olive Wood Bowl

BW_OR2100

Mat Olive Wood, Oiled
Dim 120ø × 40 mm
 4.7ø × 1.6 in

MOQ 1

Note Due to the natural variations in olive wood, bowl sizes may vary significantly and exact dimensions cannot be guaranteed.



Tilt Oak Bowls and Platters

Tilt bowls are intelligently engineered to fit seamlessly within Tilt frames.

Tilt Oak Bowls and Platters are perfect for cereal and dry salad presentation.

All timber products feature natural grain variation.



Tilt Large Oak Straight Bowl

BU_OSB007

Mat Oak, Oiled
Dim 320ø × 48mm
 12.6ø × 1.9 in
MOQ 1



Tilt Extra Large Oak Straight Platter

BU_OSB005

Mat Oak, Oiled
Dim 400ø × 28mm
 15.7ø × 1.1 in
MOQ 1



Tilt Large Oak Straight Platter

BU_OSB004

Mat Oak, Oiled
Dim 320ø × 28mm
 12.6ø × 1.1 in
MOQ 1



Tilt Oak Straight Platter

BU_OSB003

Mat Oak, Oiled
Dim 218ø × 28mm
 8.6ø × 1.1 in
MOQ 1



Tilt Mini Long Oak Straight Platter

BU_OSB008

Mat Oak, Oiled
Dim 383 × 125 × 28mm
 15.1 × 4.9 × 1.1 in
MOQ 1



Tilt Walnut Bowls and Platters

Tilt bowls are intelligently engineered to fit seamlessly within Tilt frames, with an ability to be tilted at various angles to enhance food volume.

Tilt Walnut Bowls and Platters are perfect for cereal and dry salad presentation.

All timber products feature natural grain variation.



Tilt Large Walnut Wood Bowl

BU_WR1203 •

Mat Walnut, Oiled
Dim 285ø × 100 mm
 11.2ø × 3.9 in
Vol 2.9 litres
 Approx. 102 fl oz
MOQ 1



Tilt Medium Walnut Wood Bowl

BU_WR1202 •

Mat Walnut, Oiled
Dim 250ø × 85 mm
 9.8ø × 3.3 in
Vol 1.7 litres
 Approx. 60 fl oz
MOQ 1



Tilt Small Walnut Wood Bowl

BU_WR1201 •

Mat Walnut, Oiled
Dim 215ø × 70 mm
 8.5ø × 2.7 in
Vol 0.8 litres
 (approx. 28 fl oz)
MOQ 1



Tilt Large Walnut Straight Bowl

BU_WSB007

Mat Walnut, Oiled
Dim 320ø × 48 mm
 12.6ø × 1.9 in
MOQ 1



Tilt Mini Walnut Straight Bowl

BU_WSB002

Mat Walnut, Oiled
Dim 125ø × 58 mm
 4.9ø × 2.3 in
MOQ 1



Tilt Mini Short Walnut Straight Bowl

BU_WSB001

Mat Walnut, Oiled
Dim 125ø × 38 mm
 4.9ø × 1.5 in
MOQ 1



Tilt Extra Large Walnut Straight Platter

BU_WSB005

Mat Walnut, Oiled
Dim 400ø × 28 mm
 15.7ø × 1.1 in
MOQ 1



Tilt Large Walnut Straight Platter

BU_WSB004

Mat Walnut, Oiled
Dim 320ø × 28 mm
 12.6ø × 1.1 in
MOQ 1



Tilt Walnut Straight Platter

BU_WSB003

Mat Walnut, Oiled
Dim 218ø × 28 mm
 8.6ø × 1.1 in
MOQ 1



Tilt Mini Long Walnut Straight Platter

BU_WSB008

Mat Walnut, Oiled
Dim 383 × 125 × 28 mm
 15.1 × 4.9 × 1.1 in
MOQ 1



Tilt Plinths

Perfectly proportioned plinths for cake, bread and wet or dry ambient food display.

Available in robust hardwoods, luxurious marbles and lustrous black glass.

Round plinths and the Large Black Glass Round Plinth locate securely onto Tilt frames while Long plinths are carried by pairs of frames.



Tilt Round Oak Plinth

BU_OP1109

Mat Oak, Oiled
Dim 218ø × 25 mm
8.6ø × 1 in
MOQ 1



Tilt Round Walnut Plinth

BU_WP1209 •

Mat Walnut, Oiled
Dim 218ø × 25 mm
8.6ø × 1 in
MOQ 1



Tilt Round Black Glass Plinth

BU_GP0042

Mat Glass, Black
Dim 218ø × 20 mm
8.6ø × 0.8 in
MOQ 1



Tilt Round Grey Marble Plinth

BU_MP1509 •

Mat Marble, Grey
Dim 218ø × 25 mm
8.6ø × 1 in
MOQ 1



Tilt Round White Marble Plinth

BU_MP1609 •

Mat Marble, White
Dim 218ø × 25 mm
8.6ø × 1 in
MOQ 1



Tilt Round Green Marble Plinth

BU_MP1709

Mat Marble, Verde Guatemala
Dim 218ø × 25 mm
8.6ø × 1 in
MOQ 1



Tilt Long Oak Plinth

BU_OP1108

Mat Oak, Oiled
Dim 770 × 218 × 25 mm
30.3 × 8.6 × 1 in
MOQ 1



Tilt Long Walnut Plinth

BU_WP1208 •

Mat Walnut, Oiled
Dim 770 × 218 × 25 mm
30.3 × 8.6 × 1 in
MOQ 1



Tilt Long Black Glass Plinth

BU_GP0040

Mat Glass, Black
Dim 770 × 218 × 20 mm
30.3 × 8.6 × 0.8 in
MOQ 1



Tilt Large Round Black Glass Plinth

BU_GP0041

Mat Glass, Black
Dim 320ø × 20 mm
11.6ø × 0.8 in
MOQ 1
Note Compatible with cloche BU_GC001



Tilt Glass Jars

Designed to fit with three different height Tilt frames, Tilt Glass Jars are the perfect solution for elegant cereal or ice display.

The turned walnut or oak lid can sit effortlessly on the edge of the jar for single-handed serving. The Tilt Wooden Spoon (page 89) completes the functional Tilt Jar Set. Each wooden spoon is ergonomically designed for easy handling.

Oak and Walnut Mini Glass Jars are sold separately or can be bought with lids or triple bases.



Tilt Glass Jar

BU_GJ001 •

Mat Glass, Soda Lime
Dim 218ø × 165 mm
 8.6ø × 6.5 in
Vol 3 litres
 Approx. 101 fl oz
MOQ 1
Note Compatible with standard Tilt frames



Tilt Mini Glass Jar

BU_GJ002 •

Mat Glass, Soda Lime
Dim 125ø × 95 mm
 5ø × 3.7 in
Vol 500 ml
 17 oz
Note Compatible with Tilt Mini frames.



Tilt Oak Jar Lid

BU_OL001 •

Mat Oak, Oiled
Dim 207ø × 30 mm
 8.1ø × 1.1 in
MOQ 1



Tilt Walnut Jar Lid

BU_WL001 •

Mat Walnut, Oiled
Dim 207ø × 30 mm
 8.1ø × 1.1 in
MOQ 1



Tilt Walnut Jar Base

BU_WB001

Mat Walnut, Oiled
Dim 210ø × 19 mm
 8.3ø × 0.7 in
MOQ 1



Tilt Oak Mini Glass Jar Set

SET_GJ001

Tilt Mini Glass Jar	Tilt Oak Mini Jar Lid	Tilt Oak Mini Jar Triple Base
Mat Glass, Soda Lime	Oak, Oiled	Oak, Oiled
Dim 125ø × 95 mm 5ø × 3.7 in	116ø × 17 mm 4.6ø × 0.7 in	450 × 145 × 15 mm 17.7 × 5.7 × 0.6 in
Vol 500 ml 17 oz		
MOQ 1		
Note All components available individually		



Tilt Walnut Mini Glass Jar Set

SET_GJW01

Tilt Mini Glass Jar	Tilt Walnut Mini Jar Lid	Tilt Walnut Mini Jar Triple Base
Mat Glass, Soda Lime	Walnut, Oiled	Walnut, Oiled
Dim 125ø × 95 mm 5ø × 3.7 in	116ø × 17 mm 4.6ø × 0.7 in	450 × 145 × 15 mm 17.7 × 5.7 × 0.6 in
Vol 500 ml 17 oz		
MOQ 1		
Note All components available individually		



Tilt Frames

Tilt frames feature a precision fitted rubber ring, which gently grips the bowl and plinth surfaces, allowing for curated display with secure positioning.

Available in stainless, black powder coated, or brass finished steel.



Tilt Extra Tall Stainless Steel Frame

BU_RR6104

Mat Stainless Steel
Dim 218ø × 350 mm
8.6ø × 13.7 in
MOQ 1



Tilt Tall Stainless Steel Frame

BU_RR6103 •

Mat Stainless Steel
Dim 218ø × 265 mm
8.6ø × 10.4 in
MOQ 1



Tilt Medium Stainless Steel Frame

BU_RR6102 •

Mat Stainless Steel
Dim 218ø × 180 mm
8.6ø × 7 in
MOQ 1



Tilt Low Stainless Steel Frame

BU_RR6101 •

Mat Stainless Steel
Dim 218ø × 95 mm
8.6ø × 3.7 in
MOQ 1



Tilt Extra Tall Black Frame

BU_RR6204 •

Mat Powder Coated Steel, Black
Dim 218ø × 350 mm
8.6ø × 13.7 in
MOQ 1



Tilt Tall Black Frame

BU_RR6203 •

Mat Powder Coated Steel, Black
Dim 218ø × 265 mm
8.6ø × 10.4 in
MOQ 1



Tilt Medium Black Frame

BU_RR6202 •

Mat Powder Coated Steel, Black
Dim 218ø × 180 mm
8.6ø × 7 in
MOQ 1



Tilt Low Black Frame

BU_RR6201 •

Mat Powder Coated Steel, Black
Dim 218ø × 95 mm
8.6ø × 3.7 in
MOQ 1



Tilt Extra Tall Brass Frame

BU_RR6304

Mat Brass PVD and Stainless Steel
Dim 218ø × 350 mm
8.6ø × 13.7 in
MOQ 1



Tilt Tall Brass Frame

BU_RR6303 •

Mat Brass PVD and Stainless Steel
Dim 218ø × 265 mm
8.6ø × 10.4 in
MOQ 1



Tilt Medium Brass Frame

BU_RR6302 •

Mat Brass PVD and Stainless Steel
Dim 218ø × 180 mm
8.6ø × 7 in
MOQ 1



Tilt Low Brass Frame

BU_RR6301 •

Mat Brass PVD and Stainless Steel
Dim 218ø × 95 mm
8.6ø × 3.7 in
MOQ 1



Tilt Frames

Choreograph exceptional culinary displays with the Tilt Triple Frame. Pair a stainless steel or black triple frame with juice dispensers, glass jars or a range of luxurious plinths to create visually powerful, multi-material presentations.

Three-tier frames offer ideal high tea service platforms and can be bridged with Tilt Long Plinths.



Tilt Stainless Steel Three-Tier Frame

BU_RR6105 •

Mat Stainless Steel
Dim 242 × 218 × 553 mm
 9.5 × 8.6 × 21.8 in
MOQ 1



Tilt Black Three-Tier Frame

BU_RR6205 •

Mat Powder Coated Steel, Black
Dim 242 × 218 × 553 mm
 9.5 × 8.6 × 21.8 in
MOQ 1



Tilt Stainless Steel Triple Frame

BU_TR001 •

Mat Stainless Steel
Dim 662 × 218 × 180 mm
 26 × 8.6 × 7 in
MOQ 1



Tilt Black Triple Frame

BU_TR021 •

Mat Powder Coated Steel, Black
Dim 662 × 218 × 180 mm
 26 × 8.6 × 7 in
MOQ 1



Tilt Large

The Tilt Large range features an expanded footprint to accommodate larger serving sizes and presentation surfaces. Large frames feature a precision-fitted rubber gasket, which gently grips the surface of these larger Tilt pieces, allowing them to be used at multiple angles while offering poise at height.

Luxurious marbles and natural timbers offer exceptional display surfaces in this expanded footprint.

Tilt Large Frames are available in tall, medium, and low.

Tilt Large Plinths operate on both Tilt Large and classic Tilt frame sizes. Tilt Extra Large Plinths operate only on Tilt Large Frames.



Tilt Large Tall Black Frame

BU_RR6213

Mat Powder Coated Steel, Black
Dim 320ø × 265 mm
 12.6ø × 10.4 in
MOQ 1



Tilt Large Medium Black Frame

BU_RR6212

Mat Powder Coated Steel, Black
Dim 320ø × 180 mm
 12.5ø × 7 in
MOQ 1

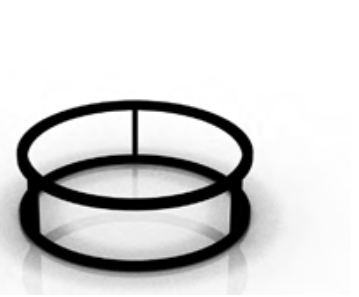

Tilt Large Low Black Frame

BU_RR6211

Mat Powder Coated Steel, Black
Dim 320ø × 95 mm
 12.6ø × 3.7 in
MOQ 1



Tilt Extra Large Round Oak Plinth

BU_OP1120

Mat Oak, Oiled
Dim 400ø × 25 mm
 15.07ø × 1 in
MOQ 1

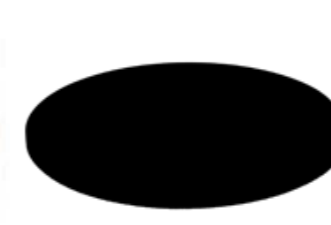

Tilt Extra Large Round Walnut Plinth

BU_WP1220

Mat Walnut, Oiled
Dim 400ø × 25 mm
 15.07ø × 1 in
MOQ 1



Tilt Large Round Oak Plinth

BU_OP1121

Mat Oak, Oiled
Dim 320ø × 25 mm
 11.6ø × 1 in
MOQ 1

Note Compatible with large glass cloches

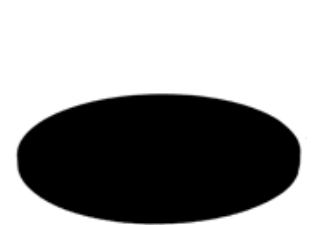

Tilt Large Round Walnut Plinth

BU_WP1219

Mat Walnut, Oiled
Dim 320ø × 25 mm
 11.6ø × 1 in
MOQ 1

Note Compatible with large glass cloches



Tilt Large Round White Marble Plinth

BU_MP1610

Mat Marble, White
Dim 320ø × 25 mm
 12.6ø × 1 in
MOQ 1



Tilt Large Round Grey Marble Plinth

BU_MP1510

Mat Marble, Grey
Dim 320ø × 25 mm
 12.6ø × 1 in
MOQ 1



Tilt Large Round Green Marble Plinth

BU_MP1710

Mat Marble, Verde Guatemala
Dim 320ø × 25 mm
 12.6ø × 1 in
MOQ 1



Tilt Mini Plinths

The Tilt Mini Plinths elevate any dining experience, adding sophistication to both casual and formal events.

Designed to complement the Tilt Mini Frame collection, they offer an elegant platform for showcasing small appetisers and canapés.



Tilt Mini Oak Plinth

BU_OP1105

Mat Oak, Oiled

Dim 125ø × 25 mm
4.92ø × 0.98 in

MOQ 1

Note Compatible with all Tilt Mini Frames



Tilt Mini Walnut Plinth

BU_WP1205

Mat Walnut, Oiled

Dim 125ø × 25 mm
4.92ø × 0.98 in

MOQ 1

Note Compatible with all Tilt Mini Frames



Tilt Mini White Marble Plinth

BU_MP1605

Mat Marble, White

Dim 125ø × 25 mm
4.92ø × 0.98 in

MOQ 1

Note Compatible with all Tilt Mini Frames



Tilt Mini Grey Marble Plinth

BU_MP1505

Mat Marble, Grey

Dim 125ø × 25 mm
4.92ø × 0.98 in

MOQ 1

Note Compatible with all Tilt Mini Frames



Tilt Mini Triple Oak Plinth

BU_OP1106

Mat Oak, Oiled

Dim 383 × 125 × 25 mm
15.08 × 4.92 × 0.98 in

MOQ 1

Note Compatible with all Tilt Mini Frames



Tilt Mini Triple Walnut Plinth

BU_WP1206

Mat Walnut, Oiled

Dim 383 × 125 × 25 mm
15.08 × 4.92 × 0.98 in

MOQ 1

Note Compatible with all Tilt Mini Frames



Tilt Mini Triple White Marble Plinth

BU_MP1606

Mat Marble, White

Dim 383 × 125 × 25 mm
15.08 × 4.92 × 0.98 in

MOQ 1

Note Compatible with all Tilt Mini Frames



Tilt Mini Triple Grey Marble Plinth

BU_MP1506

Mat Marble, Grey

Dim 383 × 125 × 25 mm
15.08 × 4.92 × 0.98 in

MOQ 1

Note Compatible with all Tilt Mini Frames



Tilt Mini Quintuple Oak Plinth

BU_OP1107

Mat Oak, Oiled

Dim 641 × 125 × 25 mm
25.24 × 4.92 × 0.98 in

MOQ 1

Note Compatible with all Tilt Mini Frames



Tilt Mini Quintuple Walnut Plinth

BU_WP1207

Mat Walnut, Oiled

Dim 641 × 125 × 25 mm
25.24 × 4.92 × 0.98 in

MOQ 1

Note Compatible with all Tilt Mini Frames



Tilt Mini Frames

The Tilt Mini Frame range is a refined and versatile solution for enhancing buffet and event presentations. Offered in three configurations — quintuple, triple, and single — and available in two heights, these frames are designed to pair with our mini jars and bowls.

Perfectly suited for a variety of settings—including bars, breakfast buffets, candy stations, VIP boxes and in-room amenities—the mini frames facilitate diverse arrangements that can accommodate an array of toppings and garnishes.

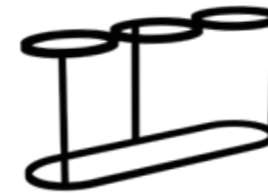

Tilt Mini Medium Stainless Steel Triple Frame

BU_TR003

Mat Stainless Steel, Polished
Dim 387 × 125 × 182 mm
 15.24 × 4.92 × 7.17 in
MOQ 1



Tilt Mini Low Triple Stainless Steel Frame

BU_TR002

Mat Stainless Steel, Polished
Dim 387 × 125 × 98 mm
 15.24 × 4.92 × 3.86 in
MOQ 1

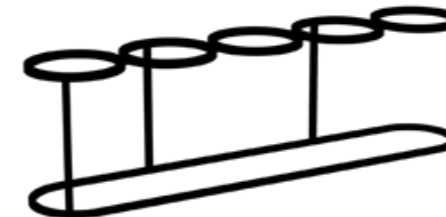

Tilt Mini Medium Quintuple Black Frame

BU_QR023

Mat Powder Coated Steel, Black
Dim 641 × 125 × 182 mm
 8.6ø × 13.7 in
MOQ 1

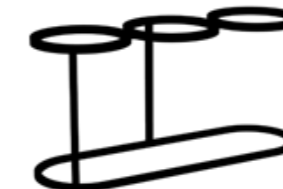

Tilt Mini Medium Triple Black Frame

BU_TR023

Mat Powder Coated Steel, Black
Dim 387 × 125 × 182 mm
 15.24 × 4.92 × 7.17 in
MOQ 1



Tilt Mini Medium Black Frame

BU_RR6232

Mat Powder Coated Steel, Black
Dim 125ø × 182 mm
 4.92ø × 7.17 in
MOQ 1

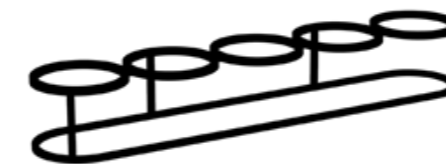

Tilt Mini Low Quintuple Black Frame

BU_QR022

Mat Powder Coated Steel, Black
Dim 641 × 125 × 98 mm
 25.24 × 4.92 × 3.86 in
MOQ 1



Tilt Mini Low Triple Black Frame

BU_TR022

Mat Powder Coated Steel, Black
Dim 387 × 125 × 98 mm
 15.24 × 4.92 × 3.86 in
MOQ 1



Tilt Mini Low Black Frame

BU_RR6231

Mat Powder Coated Steel, Black
Dim 125ø × 98 mm
 4.92ø × 3.86 in
MOQ 1



Tilt Mini Juice Dispensers

The Tilt Mini Triple Juice Dispenser is an elegant addition to any buffet setting, intelligently designed to serve chilled beverages. The streamlined silhouette harmonises a space that can often feel chaotic.

Comprising independently cooled 3 litre dispensers that can be swapped out or replenished in service, this product delivers a spill-free solution for occasions where choice and volume are essential.



**Tilt Mini Juice Dispenser
+ Stainless Steel Mini Triple Riser Set**

SET_MJDTR003

Mat Glass, Soda Lime and Stainless Steel

Dim 383 x 125 x 417 mm
15 x 5 x 16.4 in

Vol Each jar holds 3 litres
Approx. 101 fl oz

MOQ 1

Note 3 x SET_MJD
1 x BU_MJD0016: Tilt Mini Triple Drip Tray
1 x BU_TR003: Tilt Mini Med Triple Frame (Stainless Steel)



**Tilt Mini Juice Dispenser
+ Black Mini Triple Riser Set**

SET_MJDTR023

Mat Glass, Soda Lime, Stainless Steel
and Powder Coated Steel, Black

Dim 383 x 125 x 417 mm
15 x 5 x 16.4 in

Vol Each jar holds 3 litres
Approx. 101 fl oz

MOQ 1

Note 3 x SET_MJD
1 x BU_MJD0016: Tilt Mini Triple Drip Tray
1 x BU_TR023: Tilt Mini Med Triple Frame (Black)



Tilt Mini Juice Dispenser

SET_MJD

Mat Glass, Soda Lime
and Stainless Steel

Dim 125ø x 322 mm
4.92ø x 12.68 in

Vol Holds 3 litres
(approx. 101 fl oz)

MOQ 1

Note 1 x BU_MJD0017: Tilt Mini Juice Dispenser (Glass Jar)
1 x BU_MJD0010: Tilt Mini Components





Tilt Drinks Service

With its elegant curves and simple, functional features, the ice-free Tilt Juice Dispenser is a perfect addition to any group setting, quenching guests' thirst with a seamless serving experience.

The innovative ice-free cooling system keeps 8 litres of liquid (2.1 gallons) cool for up to 4 hours, ensuring seamless service across safely timed guest visits, with an intelligently designed drip tray locating easily onto the Tilt Frame for enhanced stability and reduced spills.

Hand-blown from soda lime glass, our Tilt Carafes feature a tapered neck with angled top for pouring. Ideal for serving water or juices, they can be used alone or combined with Flow Carafe Risers or Flow 2.4 Carafe Plinths to create a unique display for groups or alone for in-room or at-table dining. Add Carafe Corks to stop spills and cover drinks between services.



Tilt Juice Dispenser

SET_JD •

Note Tilt frame not included

SET_JDTR •

Note BU_RR6102 Tilt medium stainless steel frame included

Mat Glass, Soda Lime and Stainless Steel

Dim 218 x 348 x 322 mm
8.6 x 13.7 x 12.7 in

Vol Holds 8 litres
Approx 282 fl oz

MOQ 1



Tilt Large Glass Carafe

BU_CF0109 •

Mat Glass, Soda Lime

Dim 92ø x 271 mm
3.6ø x 10.7 in

Vol Holds 1 litre
(approx. 35 fl oz)

MOQ 1



Tilt Medium Glass Carafe

BU_CF0209

Mat Glass, Soda Lime

Dim 92ø x 211 mm
3.6ø x 8.3 in

Vol Holds 750 ml
(approx. fl oz)

MOQ 1



Tilt Small Glass Carafe

BU_CF0309

Mat Glass, Soda Lime

Dim 92ø x 159 mm
3.6ø x 6.3 in

Vol Holds 750 ml
(approx. fl oz)

MOQ 1



Tilt Tall Oak Carafe Riser

BU_CR0103

Mat Oak, Lacquered

Dim 116ø x 117 mm
4.6ø x 4.6 in

MOQ 1



Tilt Mid Oak Carafe Riser

BU_CR0102

Mat Oak, Lacquered

Dim 116ø x 71 mm
4.6ø x 2.8 in

MOQ 1



Tilt Low Oak Carafe Riser

BU_CR0101

Mat Oak, Lacquered

Dim 116ø x 25 mm
4.6ø x 1 in

MOQ 1



Carafe Cork

BU_CL010

Mat Cork

Dim 99 x 99 x 51 mm
3.9 x 3.9 x 2 in

MOQ 1



Flow Oak 2.4 Carafe Plinth

BU_FT0103

Mat Oak, Lacquered

Dim 530 x 162 x 20 mm
20.8 x 6.3 x 0.7 in

MOQ 1

Note Compatible with all 2.4 products



Flow Walnut 2.4 Carafe Plinth

BU_FT0203

Mat Walnut, Lacquered

Dim 530 x 162 x 20 mm
20.8 x 6.3 x 0.7 in

MOQ 1

Note Compatible with all 2.4 products

Tilt Yoghurt Dispenser

The Tilt Yoghurt Dispenser, inspired by the traditional milk churn shape, delivers both elegance and practicality. Designed to hold a full service of yoghurt, each pump dispenses a precise 1 oz (30 ml) serving.

Versatile in its setup, the dispenser can be used with the classic Tilt frame or placed on its stylish wooden rest, seamlessly blending form and function.



Tilt Yoghurt Dispenser

NQ1875_BUNDLE

Mat Powder Coated Steel, Cream, Oak and Stainless Steel
Dim 384 x 218 x 445 mm
 15.1 x 8.6 x 17.5 in
Vol Holds 4 litres
 Approx 141 fl oz

MOQ 1



Tilt Utensils

The new Tilt Buffet Utensils range is an elegant addition to any dining experience.

Available in our standard oak and walnut finishes.



Tilt Oak Spoon

BU_SP011 •

Mat Oak, Oiled
Dim 245 x 80 x 38 mm
 9.6 x 3.1 x 1.5

MOQ 1



Tilt Walnut Spoon

BU_SP001 •

Mat Walnut, Oiled
Dim 245 x 80 x 38 mm
 9.6 x 3.1 x 1.5

MOQ 1



Tilt Oak Mini Spoon

BU_SP010

Mat Oak, Oiled
Dim 155 x 35 x 20 mm
 6.1 x 1.38 x 0.79 in

MOQ 1



Tilt Walnut Mini Spoon

BU_SP000

Mat Walnut, Oiled
Dim 155 x 35 x 20 mm
 6.1 x 1.38 x 0.79 in

MOQ 1



Tilt Oak Tongs

BU_TG011

Mat Oak, Oiled
Dim 300 x 40 x 25 mm
 11.81 x 1.57 x 0.98 in

MOQ 1



Tilt Walnut Tongs

BU_TG001

Mat Walnut, Oiled
Dim 300 x 40 x 25 mm
 11.81 x 1.57 x 0.98 in

MOQ 1



Alto

Finish: Solid walnut and black metal.

Range includes: Cake stand, bowl, boards, chip pots and label holders.

Features: Removable tripod bases for multi-height display, dishwasher-safe pots.

Ideal for:
Informal presentations, grab-and-go
breakfast pastries, contemporary
afternoon tea.



Discover more



Alto Cake Stand, Bowl and Boards

Available in walnut, Alto offers flexible presentation with a range of plinths and boards with removable tripod bases for multi-height display.

A sleek collection designed to provide a competitively priced solution for ambient food display, this range is perfect for high tea presentation or grab-and-go displays.



Alto Walnut Three-Tier Cake Stand

BU_SF21346 •

Mat Walnut, Oiled
Dim 325ø × 583.5 mm
12.8ø × 23 in
MOQ 1



Alto Walnut Bowl

BU_SC21343

Mat Walnut, Oiled
Dim 325ø × 55 mm
12.8ø × 2.2 in
MOQ 1



Alto Large Walnut Board

BU_SB21352

Mat Walnut, Oiled
Dim 400ø × 20 mm
15.7ø × 0.8 in
MOQ 1



Alto Large Tall Walnut Riser

BU_SA21353 •

Mat Walnut, Oiled
Dim 400ø × 140 mm
15.7ø × 5.5 in
MOQ 1



Alto Large Low Walnut Riser

BU_SA21352

Mat Walnut, Oiled
Dim 400ø × 80 mm
15.7ø × 3.1 in
MOQ 1



Alto Small Tall Walnut Riser

BU_SA21343 •

Mat Walnut, Oiled
Dim 325ø × 140 mm
12.8ø × 5.5 in
MOQ 1



Alto Small Low Walnut Riser

BU_SA21342 •

Mat Walnut, Oiled
Dim 325ø × 80 mm
12.8ø × 3.1 in
MOQ 1



Alto Pots and Label Holders

With their black finish and bevelled base, these elegant pots are designed to complement the Alto display range.

Available in four sizes, the dishwasher-safe pots are ideal for single-serve portions and can be used on their own as an elegant highlight piece or with Alto cake stands, bowls and boards.



Alto Large Chip Pot

CP_AB003

Mat Black PVD and Stainless Steel

Dim 100ø × 100 mm
3.9ø × 3.9 in

Vol 560 ml
19 oz

MOQ 1



Alto Medium Chip Pot

CP_AB002

Mat Black PVD and Stainless Steel

Dim 85ø × 85 mm
3.3ø × 3.3 in

Vol 330 ml
11 oz

MOQ 1



Alto Small Chip Pot

CP_AB001

Mat Black PVD and Stainless Steel

Dim 66ø × 66 mm
2.6ø × 2.6 in

Vol 150 ml
5 oz

MOQ 1



Alto Mini Chip Pot

CP_AB000

Mat Black PVD and Stainless Steel

Dim 55ø × 55 mm
2.2ø × 2.2 in

Vol 100 ml
3.4 oz

MOQ 1



Alto Stainless Steel Label Holder

LH_AS001

Mat Stainless Steel

Dim 25ø × 25 mm
1ø × 1 in

MOQ 1



Alto Black Label Holder

LH_AB001 •

Mat Black PVD and Stainless Steel

Dim 25ø × 25 mm
1ø × 1 in

MOQ 1



Food & Beverage

TABLE TOP



Modern Boards

Made from solid hardwoods, our Modern, Cicchetti, Charcuterie and Canapé boards offer solutions for dining and food presentation with elevated signature Craster aesthetics.



Large Oak Modern Board

BO_CMOL
Mat Oak, Oiled
Dim 350 × 350 × 25 mm
 13.7 × 13.7 × 1 in
MOQ 1

Medium Oak Modern Board

BO_CMOM
Mat Oak, Oiled
Dim 300 × 300 × 25 mm
 11.8 × 11.8 × 1 in
MOQ 1

Small Oak Modern Board

BO_CMOS
Mat Oak, Oiled
Dim 200 × 200 × 20 mm
 7.9 × 7.9 × 0.8 in
MOQ 1



Oak Modern Board with Etched Recess

BO_CMORF
Mat Oak, Oiled
Dim 340 × 220 × 25 mm
 13.3 × 8.6 × 1 in
MOQ 1
Note Compatible with Small and Medium Copper and Brass Pots and Shaker Small Pots



Large Long Oak Modern Board

BO_CMROL
Mat Oak, Oiled
Dim 120 × 400 × 20 mm
 4.7 × 15.7 × 0.8 in
MOQ 1

Small Long Oak Modern Board

BO_CMROS
Mat Oak, Oiled
Dim 120 × 370 × 20 mm
 4.7 × 14.6 × 0.8 in
MOQ 1



Oak Steak Plate

BO_SPOM
Mat Oak, Oiled
Dim 340 × 220 × 30 mm
 13.5 × 8.6 × 1.2 in
MOQ 1
Note Compatible with Small and Medium Copper and Brass Pots and Shaker Small Pots

Cicchetti Boards

Ideal for pizzas, finger foods and sharing platters, the Cicchetti Boards take inspiration from the cuisine of Veneto.

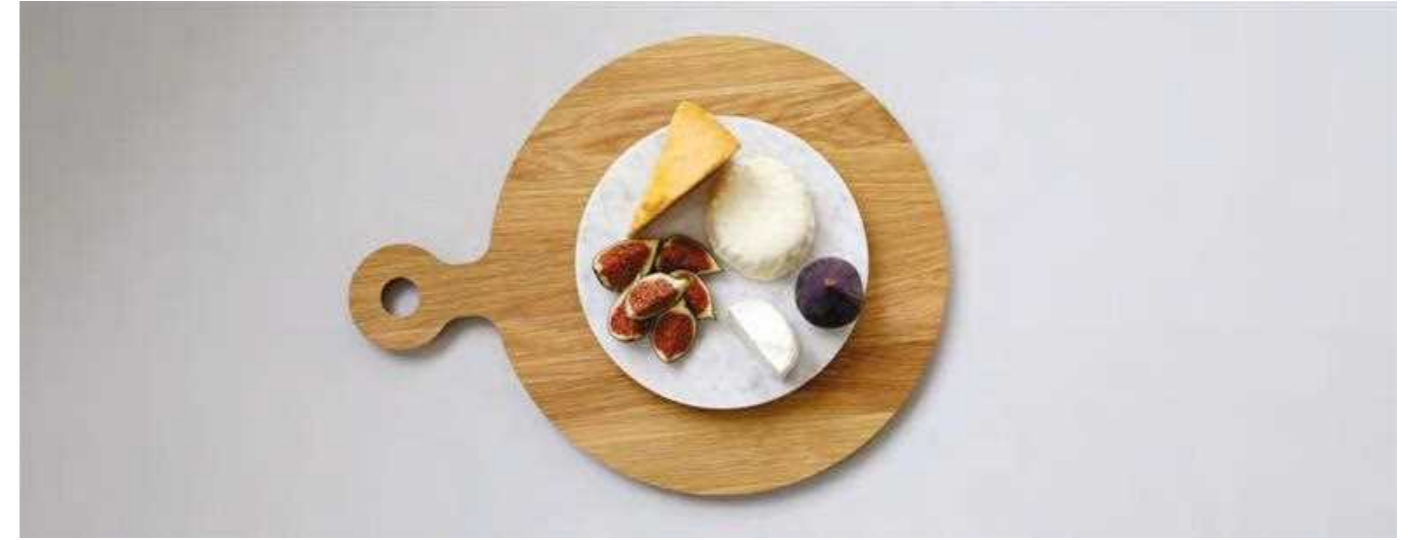

Oak Teardrop Cicchetti Board

BO_CC001
Mat Oak, Oiled
Dim 350 × 350 × 18 mm
 13.7 × 13.7 × 0.7 in
MOQ 1



Round Oak Cicchetti Board

BO_CC005
Mat Oak, Oiled
Dim 350 × 459 × 18 mm
 13.7 × 18 × 0.7 in
MOQ 1



Small Rectangular Oak Cicchetti Board with Handle

BO_CC006
Mat Oak, Oiled
Dim 313 × 170 × 18 mm
 12.3 × 6.6 × 0.7 in
MOQ 1



Large Rectangular Oak Cicchetti Board with Handle

BO_CC007
Mat Oak, Oiled
Dim 530 × 140 × 18 mm
 20.8 × 5.5 × 0.7 in
MOQ 1



Large Rectangular Oak Cicchetti Board

BO_CC004
Mat Oak, Oiled
Dim 505 × 200 × 18 mm
 19.9 × 7.9 × 0.7 in
MOQ 1



Square Oak Cicchetti Board

BO_CC002
Mat Oak, Oiled
Dim 350 × 350 × 18 mm
 13.7 × 13.7 × 0.7 in
MOQ 1

Small Rectangular Oak Cicchetti Board

BO_CC003
Mat Oak, Oiled
Dim 350 × 155 × 18 mm
 13.7 × 6.1 × 0.7 in
MOQ 1

Presentation Boards

Cut from robust oak, these Presentation Boards are ideal for casual canapé display.



Large Oak Paddle Board

BO_PBOL

Mat Oak, Oiled
Dim 510 × 200 × 18 mm
 20 × 7.9 × 0.7 in
MOQ 1

Medium Oak Paddle Board

BO_PBOM

Mat Oak, Oiled
Dim 350 × 190 × 18 mm
 13.7 × 7.4 × 0.7 in
MOQ 1

Small Oak Paddle Board

BO_PBOS

Mat Oak, Oiled
Dim 335 × 225 × 18 mm
 13.1 × 8.8 × 0.7 in
MOQ 1



Large Oak Charcuterie Board

BO_CMCHBL

Mat Oak, Oiled
Dim 500 × 200 × 15 mm
 19.7 × 7.9 × 0.6 in
MOQ 1

Medium Oak Charcuterie Board

BO_CMCHBM

Mat Oak, Oiled
Dim 350 × 190 × 15 mm
 13.8 × 7.5 × 0.6 in
MOQ 1

Background Marker Touch Up and Mineral Oil

Our Pure Mineral Oil provides protection, retaining the wood's natural colour and character while prolonging the life of your board. The oil is clear, tasteless, odourless, and food safe, making it ideal for use on wooden items including bowls, risers, and utensils. It can also be used on slate or stone.

Mineral oil can be applied with a folded kitchen paper towel.



Pure Mineral Oil Bottle, 500 ml

PC_MO1500

Mat Mineral Oil
Dim 52 × 118 × 500 mm
 2 × 4.6 × 19.7 in
MOQ 1



Background Marker Touch Up

PC_TUMPO

Colour Medium Oak
MOQ 1

PC_TUMPW

Colour Dark Walnut
MOQ 1

PC_TUMPM

Colour Mahogany
MOQ 1

PC_TUMPB

Colour Black
MOQ 1



Canapé Plinths

Elegantly-crafted walnut plinths feature scroll edges for easy handling and a smooth surface for elegant canapé presentation. These plinths are delightful as part of a large service or on their own to carry single-serve cuisine.



Large Walnut Canapé Plinth

BO_316_D

Mat Walnut, Oiled
Dim 530 × 320 × 30 mm
 20.8 × 12.6 × 1.1 in
MOQ 1



Medium Walnut Canapé Plinth

BO_316_C

Mat Walnut, Oiled
Dim 300 × 300 × 30 mm
 11.8 × 11.8 × 1.1 in
MOQ 1



Small Walnut Canapé Plinth

BO_316_B •

Mat Walnut, Oiled
Dim 310 × 155 × 30 mm
 12.2 × 6.1 × 1.1 in
MOQ 1



Long Walnut Canapé Plinth

BO_316_E

Mat Walnut, Oiled
Dim 560 × 150 × 30 mm
 22 × 5.9 × 1.1 in
MOQ 1

Chip Pots

Made from solid spun metal, with a brushed copper or brass colour exterior, these pots are ideal for single-serve portions and add warmth and material interest to the dining table.

Pots are dishwasher safe.



Large Copper Chip Pot

CP_CS003

Mat Copper PVD and
Stainless Steel

Dim 100ø × 100 mm
3.9ø × 3.9 in

Vol 560 ml
19 oz

MOQ 1



Medium Copper Chip Pot

CP_CS002

Mat Copper PVD and
Stainless Steel

Dim 85ø × 85 mm
3.3ø × 3.3 in

Vol 330 ml
11 oz

MOQ 1



Small Copper Chip Pot

CP_CS001

Mat Copper PVD and
Stainless Steel

Dim 66ø × 66 mm
2.6ø × 2.6 in

Vol 150 ml
5 oz

MOQ 1



Mini Copper Chip Pot

RP_CS000

Mat Copper PVD and
Stainless Steel

Dim 58ø × 38 mm
2.3ø × 1.5 in

Vol 100 ml
3.4 oz

MOQ 1



Large Brass Chip Pot

CP_BS003

Mat Brass PVD and
Stainless Steel

Dim 100ø × 100 mm
3.9ø × 3.9 in

Vol 560 ml
19 oz

MOQ 1



Medium Brass Chip Pot

CP_BS002

Mat Brass PVD and
Stainless Steel

Dim 85ø × 85 mm
3.3ø × 3.3 in

Vol 330 ml
11 oz

MOQ 1



Small Brass Chip Pot

CP_BS001

Mat Brass PVD and
Stainless Steel

Dim 66ø × 66 mm
2.6ø × 2.6 in

Vol 150 ml
5 oz

MOQ 1



Mini Brass Chip Pot

RP_BS000

Mat Brass PVD and
Stainless Steel

Dim 58ø × 38 mm
2.3ø × 1.5 in

Vol 100 ml
3.4 oz

MOQ 1



Shaker

Made from fine Scandinavian Aeropyl in the tradition of the 19th-century American Shaker community, this range, finished with miniature copper nails, provides chefs with a wonderfully versatile new material.

Ideal to present all manner of dry foods for single-serve, from chips to grissini sticks and bar snacks, both in gathering spaces and in guest rooms, Shaker's aesthetic is elegant and understated throughout any property.



Shaker Large Frites Pot

SH_630_D

Mat Birch Stained Black
Dim 100ø × 100 mm
3.9ø × 3.9 in
MOQ 1



Shaker Medium Frites Pot

SH_SR002

Mat Birch Stained Black
Dim 85ø × 85 mm
3.3ø × 3.3 in
MOQ 1



Shaker Small Frites Pot

SH_SR001

Mat Birch Stained Black
Dim 66ø × 66 mm
2.6ø × 2.6 in
MOQ 1
Note Compatible with Modern Oak Board with Etched Recess



Shaker Lidded Bread Basket

SH_454_A

Mat Birch Stained Black
Dim 170ø × 105 mm
6.7ø × 4.1 in
MOQ 1



Shaker Conical Bread Basket

SH_SR006

Mat Birch Stained Black
Dim 190 × 166 × 70 mm
7.5 × 6.5 × 2.8 in
MOQ 1



Shaker Large Oval Bread Basket

SH_SR005

Mat Birch Stained Black
Dim 190 × 166 × 70 mm
7.5 × 6.5 × 2.8 in
MOQ 1



Shaker Small Oval Bread Basket

SH_SR009

Mat Birch Stained Black
Dim 140 × 120 × 70 mm
5.5 × 4.7 × 2.8 in
MOQ 1



Shaker Baguette Tube

SH_SR007

Mat Birch Stained Black
Dim 122ø × 200 mm
4.8ø × 7.9 in
MOQ 1



Shaker Grissini Bread Basket

SH_SR004

Mat Birch Stained Black
Dim 60ø × 140 mm
2.3ø × 5.5 in
MOQ 1



Solo

Solo is crafted using traditional slip-casting: liquid porcelain is moulded, pressed, and hand-finished to remove imperfections. Glazed inside and high-fired for durability, every piece is dishwasher and microwave safe.

The unglazed matte exterior highlights the natural beauty of porcelain. Select forms stack, inspired by Japanese Tiffin boxes —ideal for refined, service-led plating.



Solo Cereal Bowl

BU_PA003

Mat Porcelain
Dim 128 × 128 × 64mm
 5 × 5 × 2.5 in
Vol 600 ml
 Approx. 20 fl oz
MOQ 1



Solo Large Tumbler

BU_PA007

Mat Porcelain
Dim 96 × 96 × 80mm
 3.8 × 3.8 × 3.1 in
Vol 375 ml
 Approx. 3 fl oz
MOQ 1



Solo Small Tumbler

BU_PA006

Mat Porcelain
Dim 86 × 86 × 58mm
 3.4 × 3.4 × 2.3 in
Vol 210 ml
 Approx. 7 fl oz
MOQ 1



Solo Milk Jug

BU_PA004

Mat Porcelain
Dim 78 × 78 × 72mm
 3.1 × 3.1 × 2.8 in
Vol 125 ml
 4 fl oz
MOQ 1



Solo Sauce Dish

BU_PA005

Mat Porcelain
Dim 78 × 78 × 26mm
 3.1 × 3.1 × 1 in
Vol 65 ml
 Approx. 2 fl oz
MOQ 1



Solo Jam Pot

BU_PA001

Mat Porcelain
Dim 48 × 48 × 48mm
 1.9 × 1.9 × 1.9 in
Vol 45 ml
 Approx. 2 fl oz
MOQ 1



Solo Butter Dish

BU_PA002

Mat Porcelain
Dim 76 × 76 × 10mm
 3 × 3 × 0.4 in
MOQ 1



Porcelain Condiment Pots

Introducing Craster porcelain.

Use the elegant porcelain condiment pots alone or create a statement display with a solid timber plinth, beautifully designed in oak or walnut. Pots are dishwasher safe.



Oak Porcelain Condiment Set

SET_CSO

Mat Oak, Oiled and Porcelain

Dim 260 × 100 × 65 mm
10.2 × 3.9 × 2.5 in

Vol 85 ml
3 oz

MOQ 1



Walnut Porcelain Condiment Set

SET_CSW

Mat Walnut, Oiled and Porcelain

Dim 260 × 100 × 65 mm
10.2 × 3.9 × 2.5 in

Vol 85 ml
3 oz

MOQ 1



Porcelain Amuse Bouche

Elevate small serve presentation with this delicately angled, slim-walled porcelain range.

A contemporary take on amuse bouche presentation, our intelligently-designed angled amuse bouche vessel is ideal for use with delicate, small-serve cuisine. Available in packs of six. Dishwasher safe.



Porcelain Amuse Bouche Set

SET_BU_PAB001

Mat Porcelain

Dim 98 × 58 × 25 mm
3.8 × 2.3 × 1 in

Vol 3.25 ml
0.10 oz

MOQ 1



Olive Wood Bowls

Our standalone Olive Wood Bowls have a special and vivid grain structure, making each piece unique.

Every bowl is shaped from a new piece of wood; despite our meticulous drying process, cracks can occasionally appear in the wood due to the specific nature of these natural products.



Large Olive Wood Bowl

BW_307_D

Mat Olive Wood, Oiled
Dim 300ø × 115 mm
 11.8ø × 4.5 in
MOQ 1
Note Due to the natural variations in olive wood, bowl sizes may vary significantly and exact dimensions cannot be guaranteed.



Small Olive Wood Bowl

BW_OBS

Mat Olive Wood, Oiled
Dim 115ø × 38 mm
 4.5ø × 1.5 in
MOQ 1
Note Due to the natural variations in olive wood, bowl sizes may vary significantly and exact dimensions cannot be guaranteed.



Large Olive Wood Rustic Bowl

BW_RBO •

Mat Olive Wood, Oiled
Dim 280ø × 180 mm
 11ø × 7 in
MOQ 1
Note Due to the natural variations in olive wood, bowl sizes may vary significantly and exact dimensions cannot be guaranteed.



Small Olive Wood Rustic Bowl

BW_RBOS •

Mat Olive Wood, Oiled
Dim 240ø × 185 mm
 9.4ø × 7.3 in
MOQ 1
Note Due to the natural variations in olive wood, bowl sizes may vary significantly and exact dimensions cannot be guaranteed.



Patisserie

Handmade from carefully selected, solid hardwoods, each Patisserie Riser enables beautiful pastry display. Inspired by the robust horizontal forms of Le Corbusier's architecture, our Patisserie Risers offer stackable configurations.



Large Oak Patisserie Riser

BO_BBOL •

Mat Oak, Oiled
Dim 210 × 210 × 170 mm
8.3 × 8.3 × 6.7 in

MOQ 1



Medium Oak Patisserie Riser

BO_BBOM •

Mat Oak, Oiled
Dim 210 × 210 × 140 mm
8.3 × 8.3 × 5.5 in

MOQ 1



Small Oak Patisserie Riser

BO_BBOS •

Mat Oak, Oiled
Dim 210 × 210 × 100 mm
8.3 × 8.3 × 3.9 in

MOQ 1



Long Oak Patisserie Riser

BO_BBORL •

Mat Oak, Oiled
Dim 400 × 210 × 80 mm
15.7 × 8.3 × 3.1 in

MOQ 1

Patisserie Three Step Riser



Oak Three-Step Riser

BO_BBTS •

Mat Oak, Oiled

Dim	Upper Step:	Middle Step:	Lower Step:
	400 × 250 × 90 mm	342 × 250 × 53 mm	300 × 250 × 24 mm
	15.7 × 9.8 × 3.5 in	13.4 × 9.8 × 2 in	11.8 × 9.8 × 0.9 in

MOQ 1



Patisserie Grand

The Patisserie Grand collection is carved of solid oak and walnut, selected for their grain beauty.



Tall Oak Patisserie Grand

BO_BB006
Mat Oak, Oiled
Dim 325 x 325 x 180 mm
 12.7 x 12.7 x 7 in
MOQ 1



Mid Oak Patisserie Grand

BO_BB004
Mat Oak, Oiled
Dim 325 x 325 x 115 mm
 12.7 x 12.7 x 4.5 in
MOQ 1



Low Oak Patisserie Grand

BO_BB002
Mat Oak, Oiled
Dim 325 x 325 x 80 mm
 12.7 x 12.7 x 3.1 in
MOQ 1



Tall Long Oak Patisserie Grand

BO_BB005
Mat Oak, Oiled
Dim 530 x 325 x 115 mm
 20.8 x 12.7 x 4.5 in
MOQ 1



Mid Long Oak Patisserie Grand

BO_BB003
Mat Oak, Oiled
Dim 530 x 325 x 80 mm
 20.8 x 12.7 x 3.1 in
MOQ 1



Low Long Oak Patisserie Grand

BO_BB001
Mat Oak, Oiled
Dim 530 x 325 x 40 mm
 20.8 x 12.7 x 1.5 in
MOQ 1



Tall Walnut Patisserie Grand

BO_BB012
Mat Walnut, Oiled
Dim 325 x 325 x 180 mm
 12.7 x 12.7 x 7 in
MOQ 1



Mid Walnut Patisserie Grand

BO_BB011
Mat Walnut, Oiled
Dim 325 x 325 x 115 mm
 12.7 x 12.7 x 4.5 in
MOQ 1



Low Walnut Patisserie Grand

BO_BB010
Mat Walnut, Oiled
Dim 325 x 325 x 80 mm
 12.7 x 12.7 x 3.1 in
MOQ 1



Tall Long Walnut Patisserie Grand

BO_BB009
Mat Walnut, Oiled
Dim 530 x 325 x 115 mm
 20.8 x 12.7 x 4.5 in
MOQ 1



Mid Long Walnut Patisserie Grand

BO_BB008
Mat Walnut, Oiled
Dim 530 x 325 x 80 mm
 20.8 x 12.7 x 3.1 in
MOQ 1



Low Long Walnut Patisserie Grand

BO_BB007
Mat Walnut, Oiled
Dim 530 x 325 x 40 mm
 20.8 x 12.7 x 1.5 in
MOQ 1

Cake Stands

A fresh, elegant take on a classic product with signature Craster twists. Organically shaped and turned from solid oak and walnut, our range of cake stands can be used with our glass cloches for covered display.



Large Oak Cake Stand

BU_CS007 •

Mat Oak, Lacquered
Dim 320ø × 210 mm
 12.6ø × 8.2 in
MOQ 1



Medium Oak Cake Stand

BU_CS006 •

Mat Oak, Lacquered
Dim 320ø × 136 mm
 12.6ø × 5.3 in
MOQ 1



Small Oak Cake Stand

BU_CS005 •

Mat Oak, Lacquered
Dim 157ø × 80 mm
 6.1ø × 3.1 in
MOQ 1



Large Walnut Cake Stand

BU_CS003 •

Mat Walnut, Lacquered
Dim 320ø × 210 mm
 2.6ø × 8.2 in
MOQ 1



Medium Walnut Cake Stand

BU_CS002 •

Mat Walnut, Lacquered
Dim 320ø × 136 mm
 12.6ø × 5.3 in
MOQ 1



Small Walnut Cake Stand

BU_CS001 •

Mat Walnut, Lacquered
Dim 157ø × 80 mm
 6.1ø × 3.1 in
MOQ 1



Large Glass Cloche

BU_GC001 •

Mat Glass, Soda Lime
Dim 296ø × 145 mm
 11.6ø × 5.7 in
MOQ 1
Note Compatible with Large and Medium Cake Stands, Tilt Plinths



Small Glass Cloche

BU_GC002 •

Mat Glass, Soda Lime
Dim 140ø × 106 mm
 5.5ø × 4.1 in
MOQ 1
Note Compatible with Small and Small Drum Cake Stands



Tall Large Glass Cloche

BU_GC003

Mat Glass, Soda Lime
Dim 296ø × 225 mm
 11.6ø × 8.86 in
MOQ 1
Note Compatible with Large and Medium Cake Stands, Tilt Large Plinths



Extra-Tall Large Glass Cloche

BU_GC004

Mat Glass, Soda Lime
Dim 296ø × 305 mm
 11.6ø × 12.01 in
MOQ 1
Note Compatible with Large and Medium Cake Stands, Tilt Large Plinths

Rustic Stands

Made from solid oak, our range of Rustic Display Stands have been designed to showcase and celebrate natural fresh produce.



Rustic Oak Five-Tier Floor Stand

RU_476_E

Mat Oak, Oiled
Dim 550 x 550 x 1800 mm
 21.7 x 21.7 x 70.9 in
MOQ 1
Note Assembly required

Rustic Bread Baskets, Risers and Trays

Formed of solid oak, Rustic Bread Baskets, Risers and Trays have been intelligently designed to present fine fresh breads and pastries on the dining table or buffet stand.



Rustic Regular Oak Three-Tier Stand

RU_476_D •

Mat Oak, Oiled
Dim **Upper Tier:**
 395 x 395 x 330 mm
 14.9 x 16.1 x 11.2 in
Middle Tier:
 362 x 395 x 210 mm
 13.9 x 16.1 x 7.5 in
Lower Tier:
 329 x 395 x 90 mm
 13 x 16.1 x 3.5 in
MOQ 1

Rustic Narrow Oak Three-Tier Stand

RU_476_H

Mat Oak, Oiled
Dim **Upper Tier:**
 97.5 x 395 x 330 mm
 7.8 x 15.6 x 13 in
Middle Tier:
 169.5 x 395 x 210 mm
 6.7 x 15.6 x 8.3 in
Lower Tier:
 141.5 x 395 x 90 mm
 5.6 x 15.6 x 3.5 in
MOQ 1

Rustic Mini Oak Three-Tier Stand

RU_476_G •

Mat Oak, Oiled
Dim **Upper Tier:**
 280 x 280 x 220 mm
 11 x 11 x 8.7 in
Middle Tier:
 52 x 280 x 140 mm
 10 x 11 x 5.5 in
Lower Tier:
 224 x 280 x 60 mm
 8.8 x 11 x 2.3 in
MOQ 1

Rustic Oak Two-Tier Counter Stand

RU_476_F

Mat Oak, Oiled
Dim 336 x 450 x 600 mm
 23.6 x 13.2 x 17.3 in
MOQ 1
Note Assembly required

Rustic Large Oak Deli Style Tray

RU_223_G

Mat Oak, Unoilied
Dim 500 x 300 x 188 mm
 19.7 x 11.8 x 7.4 in
MOQ 1

Rustic Medium Oak Deli Style Tray

RU_223_F

Mat Oak, Unoilied
Dim 400 x 300 x 60 mm
 15.7 x 11.8 x 2.4 in
MOQ 1

Rustic Small Oak Deli Style Tray

RU_223_E

Mat Oak, Unoilied
Dim 330 x 330 x 50 mm
 13 x 13 x 2 in
MOQ 1

Rustic Large Oak Box Riser

RU_334_B •

Mat Oak, Unoilied
Dim 200 x 200 x 200 mm
 7.9 x 7.9 x 7.9 in
MOQ 1
Note Cube risers can also be turned over to accommodate tall objects such as baguettes.

Rustic Small Oak Box Riser

RU_334_A

Mat Oak, Unoilied
Dim 150 x 150 x 150 mm
 5.9 x 5.9 x 5.9 in
MOQ 1
Note Cube risers can also be turned over to accommodate tall objects such as baguettes.

Food & Beverage

FURNITURE





Fare

- Configurable F&B distribution and display system.
- Designed for all-day operational efficiency.
- Gastronorm footprint for modular use.
- Use as standalone trolleys or expanded stations using a drop-in bridge.
- Metal frame is enhanced by reversible, replaceable hardwood or HPL panels for extended durability.
- Accessories like speed rails and concealing panels maximise functionality and optimise front-of-house use.

Ideal for:

Breakout lunches, mid-morning coffee and pastries, drop-in coffee station, Bloody Mary cart, drinks station, front bar.







Discover more

Fare Trolley System

The Fare Trolley collection offers multiple configuration options.

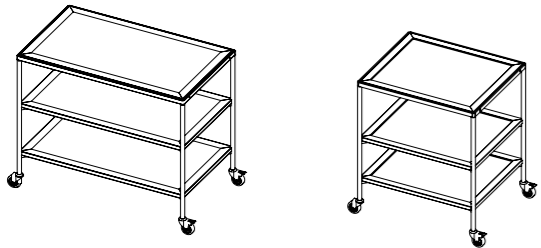
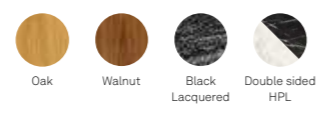
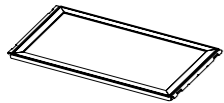
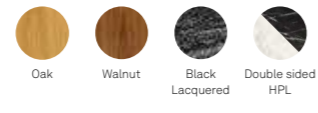
Select from solid timber or HPL options and extend presentation surfaces using the bridges, which fit between two trolleys on the short or long side.

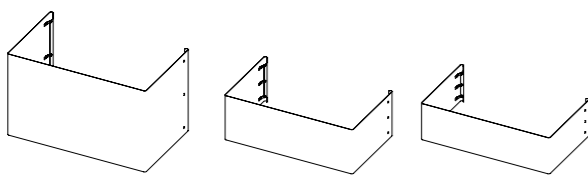
Additional accessories, such as speed rails and pots, maximise surface area, and mesh panels provide flexible, concealed storage or display.

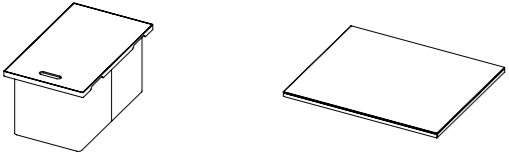
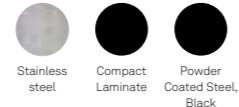
	Fare range	Material
Trolley	 <p>Fare Trolley 3.1 Fare Trolley 2.1</p>	 <p>Oak Walnut Black Lacquered Double sided HPL</p>
Bridge		 <p>Oak Walnut Black Lacquered Double sided HPL</p>
Accessories	 <p>Speed Rail Cutlery Pot Push Handle</p>	 <p>Powder Coated Steel, Black</p>
Meshes	 <p>Full Three Side Mesh Upper Three Side Mesh Lower Three Side Mesh</p>	 <p>Poly Mesh</p>
Drop Ins	 <p>Ice Well Drop-In Hot/Cold Drop-In</p>	 <p>Stainless steel Compact Laminate Powder Coated Steel, Black</p>



We've really taken our current Fare systems and our mobile F&B offering to a whole new level – our ice well and hot holding drop-ins are an essential, functional addition to the range.

James Auld, Product Design Manager at Craster



Fare Trolley System

The Fare Trolley and Bridge are designed to optimise F&B presentations, with the flexible slot-in bridge fitting on top of the trolley for transport and storage and easily bridging two trolleys to provide additional surface display.

Available in solid timber and HPL options. Accessories operate across both 3.1 and 2.1 trolleys.

Fare Trolley 3.1



Fare 3.1 Oak Trolley

TO_MOD31_OAKN

Mat Oak, Lacquered and Powder Coated Steel, Black
Dim 1100 x 650 x 880 mm
 43.3 x 25.6 x 34.6 in
MOQ 2
Note Max weight = 35 kg per shelf



Fare 3.1 Walnut Trolley

TO_MOD31_WALN

Mat Walnut, Lacquered and Powder Coated Steel, Black
Dim 1100 x 650 x 880 mm
 43.3 x 25.6 x 34.6 in
MOQ 2
Note Max weight = 35 kg per shelf



Fare 3.1 Black Trolley

TO_MOD31_OAKB

Mat Black, Lacquered and Powder Coated Steel, Black
Dim 1100 x 650 x 880 mm
 43.3 x 25.6 x 34.6 in
MOQ 1
Note Max weight = 35 kg per shelf



Fare 3.1 HPL Black and White Marble Trolley

TO_MOD31_B4245

Mat Double-Sided HPL and Powder Coated Steel, Black
Dim 1100 x 650 x 880 mm
 43.3 x 25.6 x 34.6 in
MOQ 2
Note One side features White Marble HPL, one side features Black Marble HPL. Replaces B41 finish. Max weight = 35 kg per shelf



Fare Oak Bridge

TO_MODB31_OAKN

Mat Oak, Lacquered
Dim 1100 x 650 x 28 mm
 43.3 x 25.6 x 1.1 in
MOQ 2
Note Max weight = 20 kg per shelf



Fare Walnut Bridge

TO_MODB31_WALN

Mat Walnut, Lacquered
Dim 1100 x 650 x 28 mm
 43.3 x 25.6 x 1.1 in
MOQ 2
Note Max weight = 20 kg per shelf



Fare Black Bridge

TO_MODB31_OAKB

Mat Black, Lacquered
Dim 1100 x 650 x 28 mm
 43.3 x 25.6 x 1.1 in
MOQ 1
Note Max weight = 20 kg per shelf



Fare HPL Black and White Marble Bridge

TO_MODB31_B4245

Mat Double-Sided HPL
Dim 1100 x 650 x 28 mm
 43.3 x 25.6 x 1.1 in
MOQ 2
Note One side features White Marble HPL, one side features Black Marble HPL. Replaces B41 finish. Max weight = 35 kg per shelf

Fare Trolley 2.1



Fare 2.1 Black Trolley

TO_MOD21_OAKB

Mat Black, Lacquered and Coated Steel, Black
Dim 791 x 669 x 897 mm
 31.14 x 26.34 x 35.31 in
MOQ 1
Note Max weight = 25 kg per shelf



Fare 2.1 Oak Trolley

TO_MOD21_OAKN

Mat Oak, Lacquered and Powder Coated Steel, Black
Dim 791 x 669 x 897 mm
 31.14 x 26.34 x 35.31 in
MOQ 2
Note Max weight = 25 kg per shelf



Fare 2.1 Walnut Trolley

TO_MOD21_WALN

Mat Walnut, Lacquered and Powder Coated Steel, Black
Dim 791 x 669 x 897 mm
 31.14 x 26.34 x 35.31 in
MOQ 2
Note Max weight = 25 kg per shelf



Fare 2.1 Laminate Black and White Marble

TO_MOD21_B4245

Mat Double-Sided HPL and Powder Coated Steel, Black
Dim 791 x 669 x 897 mm
 31.14 x 26.34 x 35.31 in
MOQ 2
Note Max weight = 25 kg per shelf



Fare Trolley Accessories

Fare Trolley Accessories offer additional functionality to the trolley system, with speed rails and pots slotting on to the top of the trolley that are ideal for bottles, cutlery or merchandising, and mesh panels providing covered solutions, which roll up for easy storage.



Fare Trolley Speed Rail

TO_MOD_SRGNMSPCB

Mat Powder Coated Steel, Black
Dim 650 x 123 x 212 mm
 25.6 x 4.8 x 8.4 in
MOQ 1
Note Max weight = 10 kg



Fare Trolley Cutlery Pot

TO_MOD_CPMSPCB

Mat Powder Coated Steel, Black
Dim 125 x 78 x 152 mm
 4.9 x 3.1 x 6 in
MOQ 1
Note Max weight = 3 kg



Fare Trolley Push Handle

TO_MOD_PHGNMSPCB

Mat Powder Coated Steel, Black
Dim 650 x 93 x 25 mm
 25.6 x 3.6 x 1 in
MOQ 1



Fare Trolley Full Three Side Mesh

TO_MOD_MP31F3MEB

Mat Poly Mesh, Elastic, Press Studs
Dim 2716 x 667 mm
 107 x 26.3 in
MOQ 1
Note Operates only with 3.1 trolley size.



Fare Trolley Upper Three Side Mesh

TO_MOD_MP31U3MEB

Mat Poly Mesh, Elastic, Press Studs
Dim 2716 x 317 mm
 107 x 12.5 in
MOQ 1
Note Operates only with 3.1 trolley size.

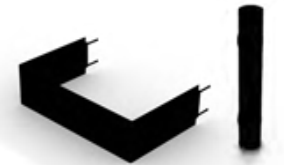

Fare Trolley Lower Three Side Mesh

TO_MOD_MP31L3MEB

Mat Poly Mesh, Elastic, Press Studs
Dim 2716 x 395 mm
 107 x 15.5 in
MOQ 1
Note Operates only with 3.1 trolley size.



Fare Ice Well / Heating and Cooling

Fare flexibility showcases signature Craster lightness and dexterity to front-of-house theatre.

Gastronorm drop-in solutions expand the Fare range's agility. Create stunning hot, cool, and ambient cuisine displays with dual-function hot and cold units or expand mobile cocktail bars with drainable ice well units.

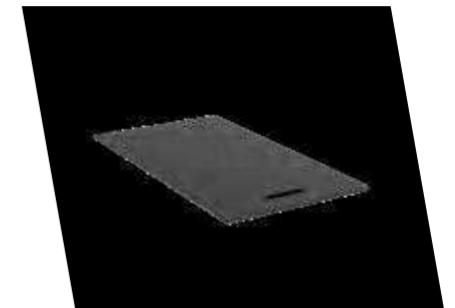
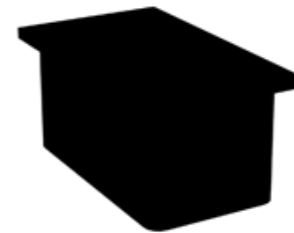

Fare Ice Well Drop-In (+ Lid)

TO_MOD_DI11IWD

Mat Stainless Steel
Dim 624 × 373 × 313 mm
 24.57 × 14.7 × 12.3 in
MOQ 1



Fare Ice Well Lid

TO_MOD_DI11IWD

Mat Compact Laminate
Note Comes with the Ice Well

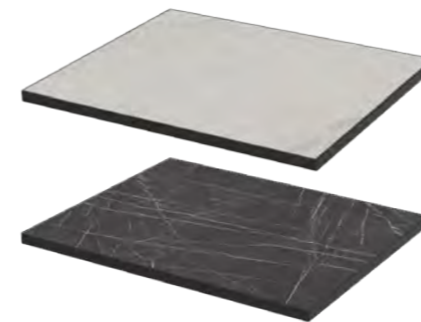

Fare 2/3 Filler Top (for use with drop-ins on 3.1 trolley)

TO_MOD_FP31LAM23

Mat Double Sided HPL - Black Marble / White Marble
Dim 326 × 624 × 25 mm
 12.8 × 24.6 × 0.98 in
MOQ 1
Note Compatible with Fare Trolley 1.1 Ice Well Drop In.

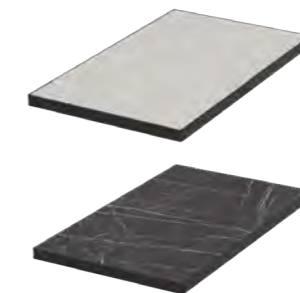

Fare 1/2 Filler Top (for use with drop-ins on 2.1 trolley)

TO_MOD_FP21LAM12

Mat Double Sided HPL - Black Marble / White Marble
Dim 373 × 624 × 25 mm
 14.7 × 24.6 × 0.98 in
MOQ 1
Note Compatible with Fare Trolley 1.1 Ice Well Drop In.

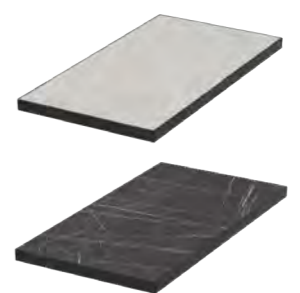

Fare 1/3 Filler Top (For use with 2 drop-ins on 3.1 trolley)

TO_MOD_FP31LAM13

Mat Double Sided HPL - Black Marble / White Marble
Dim 326 × 624 × 25 mm
 12.8 × 24.6 × 0.98 in
MOQ 1
Note Compatible with Fare Trolley 1.1 Ice Well Drop In.

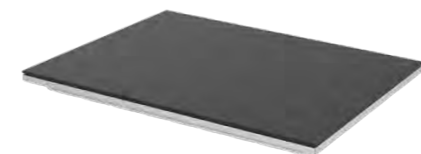

Fare Trolley 2.1 Hot Holding Drop-In

TO_MOD_DI21HO

Mat Stainless Steel, Dekton
Dim 746 × 624 × 49 mm
 29.37 × 24.57 × 1.93 in
MOQ 1
Note For use with Fare Trolley 2.1 only - Not for cooking



Stak

- Built around the Gastronorm footprint.
- Adjustable shelves that tilt.
- Discreet raised edges to secure Flow trays.
- Bridging capability between frames.
- Height adjustable.
- Combines F&B buffet and events furniture in a single system.
- Helps reduce hospitality inventory across multiple properties.

Ideal for:
Back bar, vertical buffet, room divider,
grab-and-go.



Discover more

Stak Shelving Unit

The Stak Shelving Unit adds agility to front-of-house displays with a unique, intuitive construction. Each shelf within the frame can be angled or flat to offer dynamic presentation and storage surfaces, and bridges connect shelving units to lengthen merchandising areas. Wheels and cable management provide further flexibility to the Stak system.

Coverage panels and signage accessories available on request.

Stak range

Material

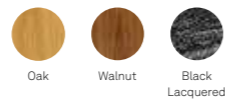
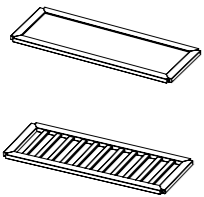
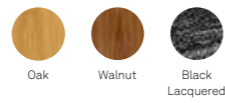
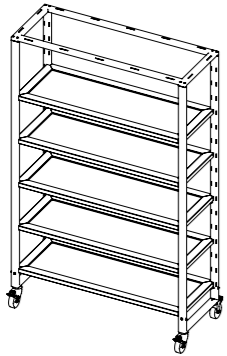

Cable clip



Nylon

Stak Shelving Unit

Shelves / Bridge

Accessories



Our Stak Shelving System is so versatile—it can be a grab-and-go station or a back bar and so much more.

Jane Murray, Head of Product at Craster

Stak Shelving Unit

The Stak System is composed of shelving components, bridges and accessories. Start by selecting a shelving unit, then build out the front-of-house display by compiling more within the Stak suite.

Contact Craster for signage accessories.



Stak Oak Shelving Unit

SV_MOD21_ON

Mat Oak, Lacquered and Powder Coated Steel, Black
Dim 1231 x 450 x 2013 mm
 48.5 x 17.7 x 79.3 in
MOQ 1
Note Max weight = 25 kg per shelf



Stak Walnut Shelving Unit

SV_MOD21_WN

Mat Walnut, Lacquered and Powder Coated Steel, Black
Dim 1231 x 450 x 2013 mm
 48.5 x 17.7 x 79.3 in
MOQ 1
Note Max weight = 25 kg per shelf



Stak Black Shelving Unit

SV_MOD21_OB

Mat Black, Lacquered and Powder Coated Steel, Black
Dim 1231 x 450 x 2013 mm
 48.5 x 17.7 x 79.3 in
MOQ 1
Note Max weight = 25 kg per shelf

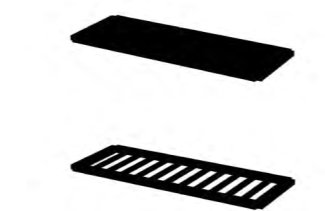

Stak Oak Shelf / Bridge

SV_MOD21_SHON

Mat Oak, Lacquered
Dim 1179 x 444 x 30 mm
 46.4 x 17.4 x 1.2 in
MOQ 1
Note Max weight = 25 kg per shelf



Stak Walnut Shelf / Bridge

SV_MOD21_SHWN

Mat Walnut, Lacquered
Dim 1179 x 444 x 30 mm
 46.4 x 17.4 x 1.2 in
MOQ 1
Note Max weight = 25 kg per shelf



Stak Black Shelf / Bridge

SV_MOD21_SHOB

Mat Black, Lacquered
Dim 1179 x 444 x 30 mm
 46.4 x 17.4 x 1.2 in
MOQ 1
Note Max weight = 25 kg per shelf



Stak Cable Clip

SV_MOD_CC

Mat Nylon
Dim 54 x 23 x 23 mm
 2.1 x 0.9 x 0.9 in
MOQ 1

Stak Oak Slatted Shelf / Bridge

SV_MOD21_SLTSHON

Mat Oak, Lacquered
Dim 1179 x 444 x 30 mm
 46.4 x 17.4 x 1.2 in
MOQ 1
Note For use with Stak Shelving Unit;
 Max weight = 20 kg per shelf

Stak Walnut Slatted Shelf / Bridge

SV_MOD21_SLTSHWN

Mat Walnut, Lacquered
Dim 1179 x 444 x 30 mm
 46.4 x 17.4 x 1.2 in
MOQ 1
Note For use with Stak Shelving Unit;
 Max weight = 20 kg per shelf

Stak Black Slatted Shelf / Bridge

SV_MOD21_SLTSHOB

Mat Black, Lacquered
Dim 1179 x 444 x 30 mm
 46.4 x 17.4 x 1.2 in
MOQ 1
Note For use with Stak Shelving Unit;
 Max weight = 20 kg per shelf



Stak + Fare: A Mobile F&B Toolkit

Stak + Fare redefine flexibility in hospitality, transforming spaces effortlessly with minimal inventory.

A single set of frames seamlessly adapts to multiple uses—from back bar to outdoor dining, grab-and-go to banqueting—ensuring operational agility without compromising aesthetics.

The Stak adjustable shelving and bridging system pairs with Fare modular trolleys and surfaces, allowing teams to reconfigure layouts in real time.

The result? A dynamic, space-efficient setup that evolves with service needs, reducing storage while maintaining a cohesive look.

Designed for premium hospitality, this intelligent, mobile system brings efficiency, elegance, and adaptability to every venue.

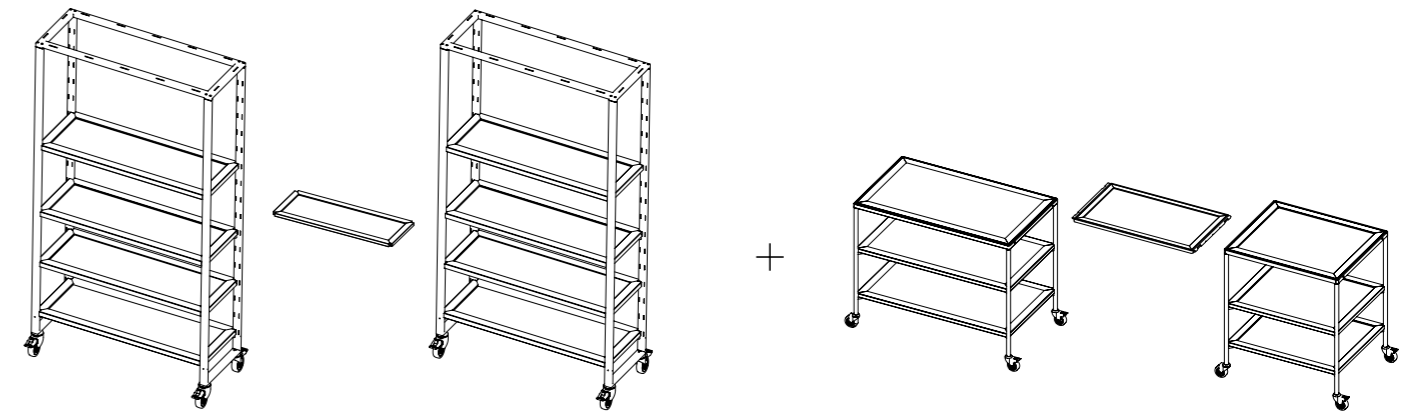

Stak

Fare

One System, Endless Possibilities

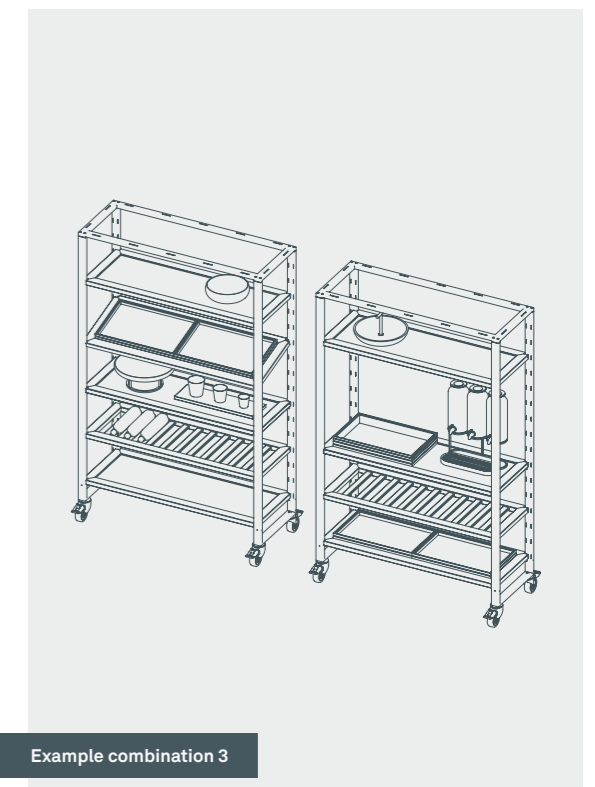
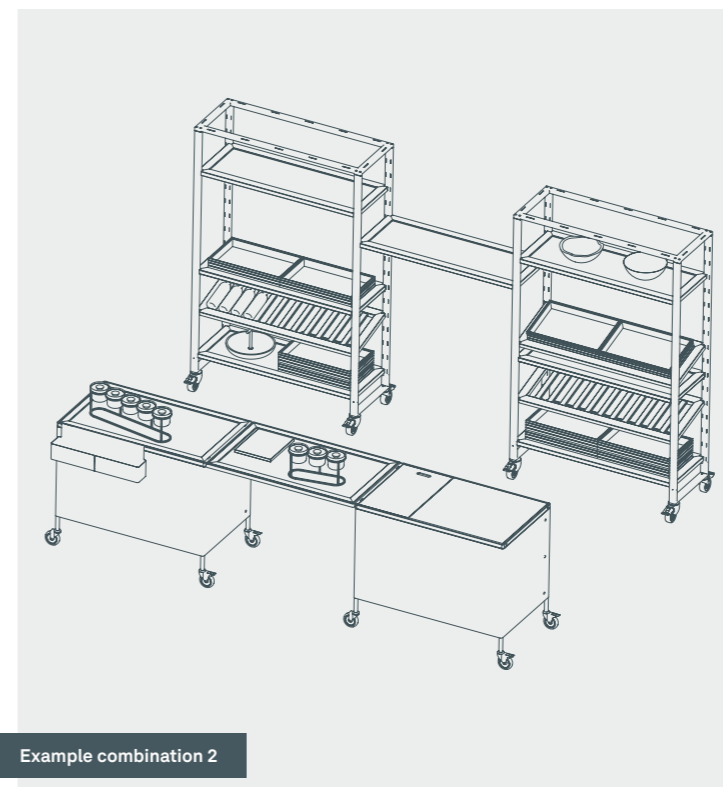
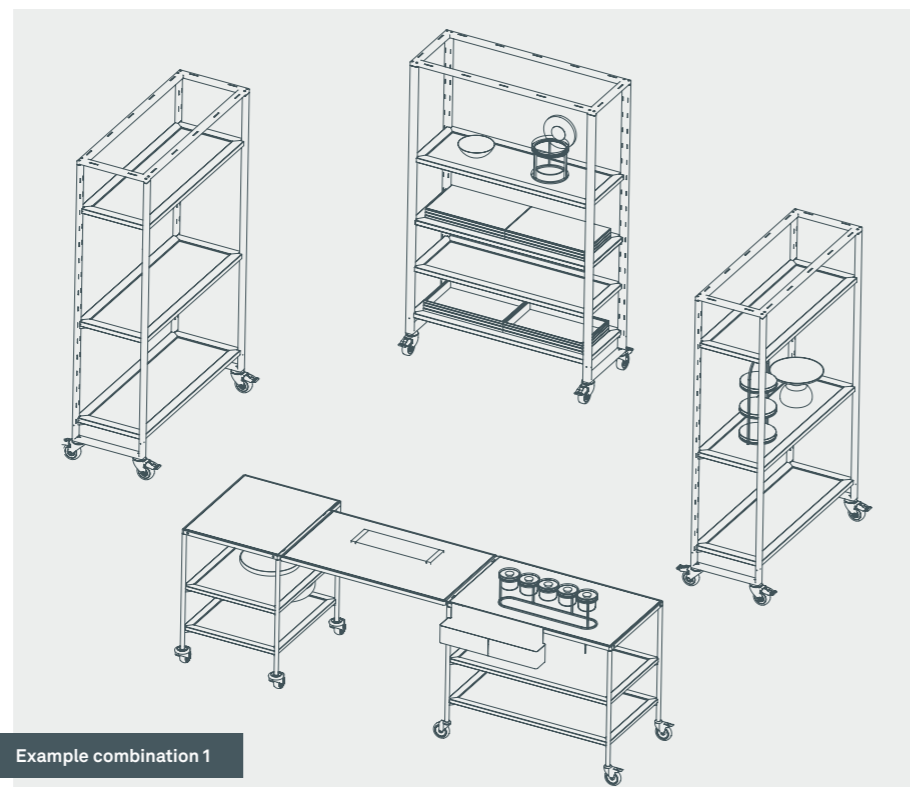

Watch the video

Food & Beverage

IN-ROOM DINING





Trays

Craster's origins. Lightweight yet durable, our range of tray styles, with and without legs, are ideal for in-room dining and breakfast in bed. Breakfast preparation racks and tray stands are available to complete an in-room food and beverage offering. Our Trays are available as standard in the materials noted per design. For bespoke materials, or sizes, please contact your Craster representative. All custom designs are subject to an MOQ of 96 units.



Rectangular Modern Tray

TA_CMML
Mat Mahogany, Lacquered
 TA_CMOL
Mat Oak, Lacquered
 TA_CMBOL •
Mat Black, Lacquered
Dim 600 x 400 x 40 mm
 23.6 x 15.7 x 1.6 in
MOQ 1
Note Fits: TO_GNL12 / TO_GNL2



Square Modern Tray

TA_CMMM
Mat Mahogany, Lacquered
 TA_CMOM
Mat Oak, Lacquered
Dim 400 x 400 x 40 mm
 15.7 x 15.7 x 1.6 in
MOQ 1



Modern Tray with Steel Handles

TA_CMSSM
Mat Mahogany, Lacquered
 TA_CMSSO
Mat Oak, Lacquered
 TA_CMSSBO
Mat Black, Lacquered
Dim 626 x 400 x 40 mm
 24.6 x 15.7 x 1.6 in
MOQ 1
Note Fits: TO_GNL12 / TO_GNL24



Large Classic Butler Tray

TA_BUTML
Mat Mahogany, Lacquered
 TA_BUTWL
Mat Walnut, Lacquered
Dim 610 x 405 x 69 mm
 24 x 15.9 x 2.7 in
MOQ 1
Note Fits: TO_GNL12 / TO_GNL24



Mahogany Jersey Butler Tray

TA_JERML
Mat Mahogany, Lacquered
Dim 610 x 444 x 57 mm
 24 x 17.4 x 2.2 in
MOQ 1



Mahogany Self-Service Tray

TA_SELML
Mat Mahogany, Lacquered
Dim 640 x 445 x 38 mm
 25.2 x 17.5 x 1.5 in
MOQ 1

Medium Mahogany Classic Butler Tray

TA_BUTMM
Mat Mahogany, Lacquered
Dim 468 x 303 x 69 mm
 18.4 x 11.9 x 2.7 in
MOQ 1

Materials and Colours



Oak



Walnut



Mahogany



Black

Trays

Craster Trays provide light and yet sturdy serving surfaces that will accommodate both traditional English and Continental breakfasts.

Legs are perfectly designed to lock when folded and also when extended.



Modern Breakfast Tray with Legs

TA_ML001
Mat Stained Wenge, Lacquered
Dim Open: 626 x 400 x 285 mm
 24.6 x 15.7 x 11.2 in
Dim Closed: 626 x 400 x 73 mm
 24.6 x 15.7 x 2.9 in
MOQ 1



Classic Breakfast Tray with Legs

TA_BTW
Mat Walnut, Lacquered
Dim Open: 600 x 450 x 304 mm
 23.6 x 17.7 x 12 in
Dim Closed: 600 x 450 x 92 mm
 23.6 x 17.7 x 3.6 in
MOQ 1



Butler Tray Stand

SR_BTSM
Mat Mahogany, Lacquered
SR_BTSSBO
Mat Black, Lacquered
SR_BTSTW
Mat Walnut, Lacquered
Dim 565 x 355 x 715 mm
 22.2 x 14 x 28.1 in
MOQ 1
Note Fits: All trays except for Medium Classic Butler Tray and Square Modern Tray



Single Steel Tray Racks

TO_GNL12
Mat Powder Coated Steel, Grey
Dim 690 x 478 x 1674 mm
 27.1 x 18.8 x 65.9 in
MOQ 1

Double Steel Tray Racks

TO_GNL24
Mat Powder Coated Steel, Grey
Dim 1355 x 478 x 1674 mm
 53.3 x 18.8 x 65.9 in
MOQ 1
Note Fits: TA_CMML / TA_CMBOL / TA_CMOL / TA_CMSSBO / TA_BUTML / TA_BUTWL / TA_BUTOL and fully prepared room service trays
 Clearance between runners is 120 mm / 4.7 in

Folding Tray Table

Designed as a contactless delivery solution for in-room dining, poolside service and lounge or restaurant table extension. The versatile Folding Tray Table has powerful magnets that connect it to the base and can easily detach for ease of storage.

Available with locking magnets in tall or without in tall or short sizes.



Watch the video



Folding Tray Table, Tall – Locking

SET_LT_WN002
Mat Walnut, Lacquered
Dim 400 x 600 x 749 mm
 15.8 x 23.6 x 29.5 in
MOQ 1



Folding Tray Table, Tall – Non-locking

SET_FT_WN002
Mat Walnut, Lacquered
Dim 400 x 600 x 749 mm
 15.8 x 23.6 x 29.5 in
MOQ 1



Folding Tray Table, Short – Non-locking

SET_FT_WN001
Mat Walnut, Lacquered
Dim 400 x 600 x 459 mm
 15.8 x 23.6 x 18.1 in
MOQ 1

Food & Beverage

CONTRACT



Wave Tray

Understated elegance complements the underlying innovation behind the Wave Tray. Designed with a robust non-slip rubber overmoulding, the tray surface will never peel, meaning reduced replacements and a dishwasher-safe, hard-performing finish.

The tray's miniature locating feet are intelligently engineered to allow for aeration when stacked, with no water buildup or residue, enabling reduced maintenance and a consistent, high-quality experience.

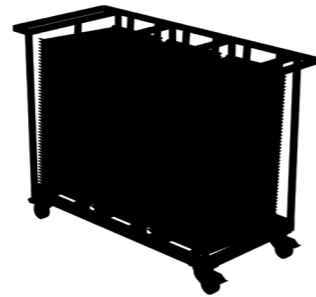

Wave Tray

TA_SGW
Mat ABS
Dim 460 x 318 x 25 mm
 18.1 x 12.5 x 1 in
MOQ 1
Note Features: Anti-slip functionality



Triple Tray Redistribution Trolley

NQ439_C
Mat Brushed Stainless Steel
Dim 1305W x 568D x 916H mm
 51.3 x 22.3 x 36.1 in
MOQ 4
Note Stores 150 Wave trays

Service Trolleys

Available with or without folding sides, our durable trolleys feature a reinforced frame and are ideal for front-of-house service. Custom glass inserts are available upon request.

Trolleys are available in natural and black lacquered oak.



Trolley with Folding Sides

TO_LDtblk
Mat Black, Lacquered
MOQ 1
TO_LDT
Mat Oak, Lacquered
MOQ 1
Dim 1922 x 585 x 954 mm
 75.7 x 23 x 37.5 in
Note Fits: Craster Service Trays
 Features: Rubber Bumpers, Locking Castors, Brushed Stainless Steel Handle

Black Service Tray Trolley

TO_LDTBNF
Mat Black, Lacquered
MOQ 5
TO_LDTNF
Mat Oak, Lacquered
MOQ 5
Dim 1075 x 585 x 954 mm
 42.3 x 23 x 37.5 in
Note Fits: Craster Service Trays
 Features: Rubber Bumpers, Locking Castors, Brushed Stainless Steel Handle

Black Modern Tray Trolley

TO_CtTOB
Mat Black, Lacquered
MOQ 1
TO_CtTO
Mat Oak, Lacquered
MOQ 5
Dim 915 x 535 x 959 mm
 36 x 21 x 37.8 in
Note Fits: Craster Modern Trays
 Features: Rubber Bumpers, Locking Castors, Brushed Stainless Steel Handle
 Assembly required

Conference, Events, Banqueting

FURNITURE





Line

Features: Lightweight tops and a compact, folding leg system for hygiene-focused, linenless table design.

Intuitive: Locking system with ergonomic grip allows single-person setup, breakdown, and changeover —no tools needed.

Sizes and shapes: Available in 1800mm and 1500mm; shapes include rectangular, classroom, trapezoid, and half-round for versatile configurations.

Components: Includes tabletops, legs, optional modesty panels, optional cable management, and mandatory trolleys.

Construction: HPL tops with durable Reef edges; legs and undersides match in colour, with recommended pairings and custom options available.

Storage and transport: Trolleys store eight tops and legs, offering high stacking density for efficient transport and storage. Legs fold to 43mm (1.7in) width; table tops slot beneath the trolley for efficient, compact storage.



Discover more

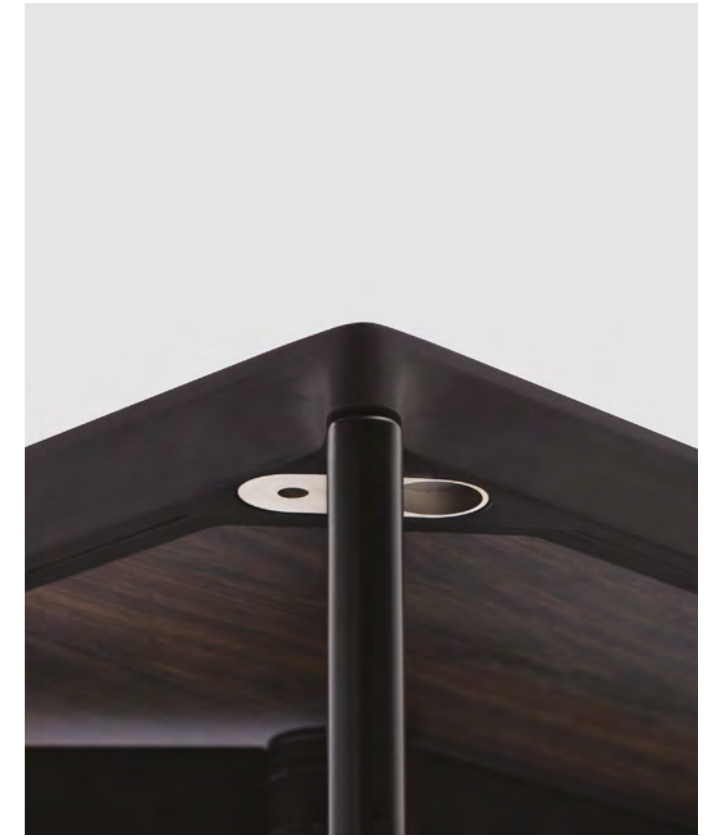
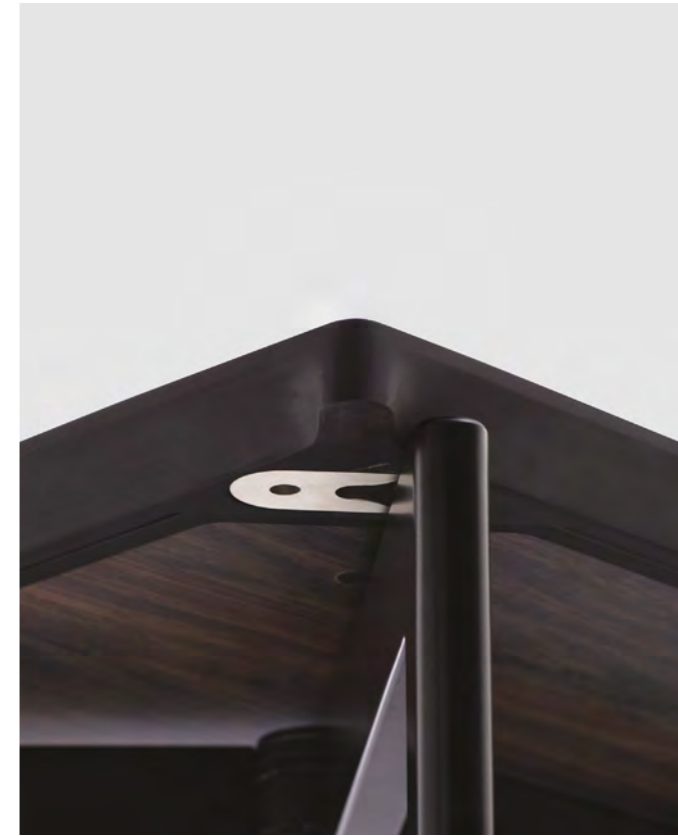
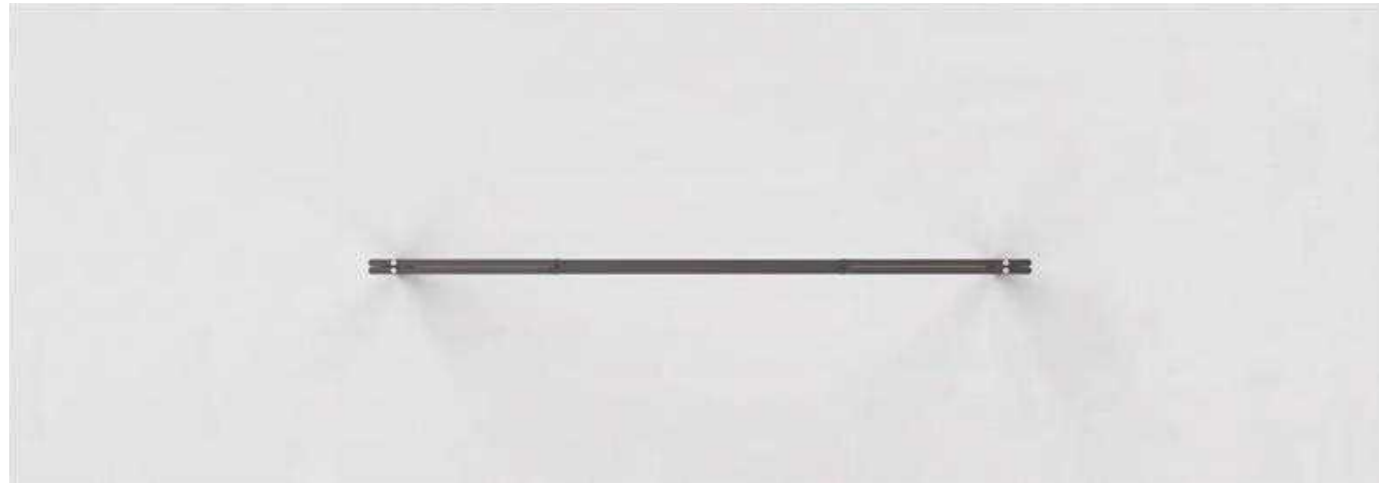

Intuitive Set-Up

Intuitive locking system and ergonomic grip for seamless set-up, breakdown and changeover. No tools required.

Wipe-Clean Hygiene

ISO 22196 compliant laminate tops offer wipe-clean ease.

Compact Storage

Legs collapse to 42mm (1.7 inches), with tops slotting underneath on the trolley for class-leading storage density back-of-house.



Line Table System

The Line Table System is available in two sizes – 1800mm and 1500mm – and in four different shapes – rectangular, classroom, trapezoid and half round – to create various configurations to suit any space requirement. Line consists of five different elements: table tops, legs, modesty panels (optional), cable management (optional) and trolleys.

Also available in dimensions 1800 x 600 mm and 1500 x 600 mm.

Please contact your Craster representative for further information.

1800 Range

1800 x 900 mm
71 x 35.4 in

1500 Range

1500 x 750 mm
59 x 29.5 in

Table Tops

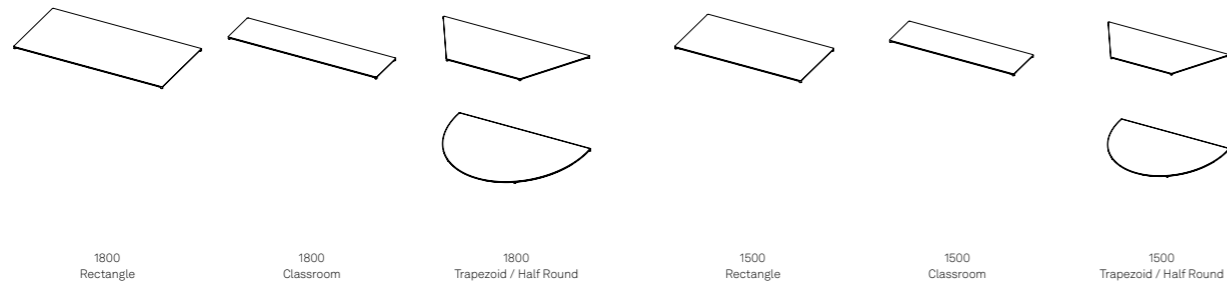

Legs



Storage Trolleys

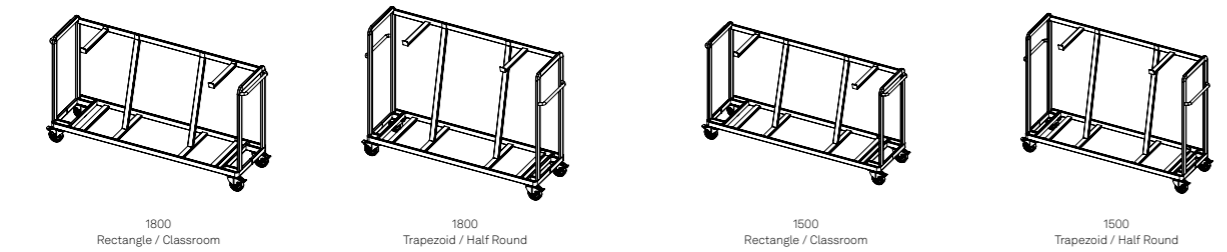

Modesty Panels



Cable Management

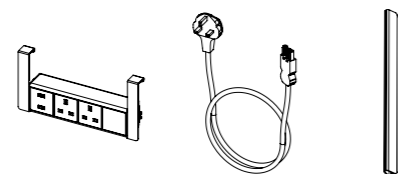



Line Table Tops

Line Table Top sizes and shapes are shown below. Table top finish customisation is available – see below for options.

Also available in dimensions 1800 × 600 mm and 1500 × 600 mm.

Please contact your Craster representative for further information.



Line 1800 Rectangle Top

CB_TR1890
(*B11, *B13, *D15, *B42, *D45, *B01)

Mat HPL, PU Edge
Dim 1800 × 900 × 25 mm
71 × 35.4 × 1 in
MOQ 10



Line 1800 Classroom Top

CB_TC1845
(*B11, *B13, *D15, *B42, *D45, *B01)

Mat HPL, PU Edge
Dim 1800 × 450 × 25 mm
71 × 17.7 × 1 in
MOQ 10



Line 1800 Trapezoid Top

CB_TT1890
(*B11, *B13, *D15, *B42, *D45, *B01)

Mat HPL, PU Edge
Dim 1800 × 780 × 25 mm
71 × 30.7 × 1 in
MOQ 10



Line 1800 Half Round Top

CB_TH1890
(*B11, *B13, *D15, *B42, *D45, *B01)

Mat HPL, PU Edge
Dim 1800 × 900 × 25 mm
71 × 35.4 × 1 in
MOQ 10



Line 1500 Rectangle Top

CB_TR1575
(*B01, *B11, *B13, *D15, *B42, *D45)

Mat HPL, PU Edge
Dim 1500 × 750 × 25 mm
59 × 29.5 × 1 in
MOQ 10



Line 1500 Classroom Top

CB_TC1545
(*B01, *B11, *B13, *D15, *B42, *D45)

Mat HPL, PU Edge
Dim 1500 × 450 × 25 mm
59 × 17.7 × 1 in
MOQ 10



Line 1500 Trapezoid Top

CB_TT1575
(*B11, *B13, *D15, *B42, *D45, *B01)

Mat HPL, PU Edge
Dim 1500 × 650 × 25 mm
59 × 25.6 × 1 in
MOQ 10



Line 1500 Half Round Top

CB_TH1575
(*B11, *B13, *D15, *B42, *D45, *B01)

Mat HPL, PU Edge
Dim 1500 × 750 × 25 mm
59 × 29.5 × 1 in
MOQ 10

Table Tops and Edge

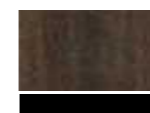

B11
Tobacco + Black



B13
Light Walnut + Black



D15
Acacia + Grey



B42
Dark Marble + Black



D45
White Marble + Grey



B01
Érable Wenge + Black



Line Table Legs

Line Table Legs are shown in Black (B00) below. Table leg finish customisation is available – see below for options.



Line 1800 Rectangle Legs

CB_LR1890 (*B00, *D00)

Mat	Powder Coated Steel	
Dim	Open:	Folded:
	1800 × 900 × 722 mm	2174 × 42 × 722 mm
	71 × 35.4 × 28.4 in	85.6 × 1.7 × 28.4 in
MOQ	20	
Note	Fits: 1800 Rectangle products	



Line 1800 Classroom Legs

CB_LC1845 (*B00, *D00)

Mat	Powder Coated Steel	
Dim	Open:	Folded:
	1800 × 450 × 722 mm	1987 × 42 × 722 mm
	71 × 17.7 × 28.4 in	78.2 × 1.7 × 28.4 in
MOQ	20	
Note	Fits: 1800 Classroom products	



Line 1800 Trapezoid / Half Round Legs

CB_LT1890 (*B00, *D00)

Mat	Powder Coated Steel	
Dim	Open:	Folded:
	1800 × 780 × 722 mm	1993 × 42 × 722 mm
	71 × 30.7 × 28.4 in	78.5 × 1.7 × 28.4 in
MOQ	20	
Note	Fits: 1800 Trapezoid products	



Line 1500 Rectangle Legs

CB_LR1575 (*B00, *D00)

Mat	Powder Coated Steel	
Dim	Open:	Folded:
	1500 × 750 × 722 mm	1812 × 42 × 722 mm
	59 × 29.5 × 28.4 in	71.3 × 1.7 × 28.4 in
MOQ	20	
Note	Fits: 1800 Rectangle products	



Line 1500 Classroom Legs

CB_LC1545 (*B00, *D00)

Mat	Powder Coated Steel	
Dim	Open:	Folded:
	1500 × 450 × 722 mm	1687 × 42 × 722 mm
	59 × 17.7 × 28.4 in	66.4 × 1.7 × 28.4 in
MOQ	20	
Note	Fits: 1500 Classroom products	



Line 1800 Trapezoid / Half Round Legs

CB_LT1890 (*B00, *D00)

Mat	Powder Coated Steel	
Dim	Open:	Folded:
	1500 × 650 × 722 mm	1658 × 42 × 722 mm
	59 × 25.6 × 28.4 in	65.3 × 1.7 × 28.4 in
MOQ	20	
Note	Fits: 1500 Trapezoid products	

Legs



B00
Black



D00
Grey



Line Modesty Panels

Line Table Modesty Panels are shown in Black (B00) below. Modesty panel customisation is available – see below for options.



Line 1800 Rectangle / Classroom Modesty Panel

CB_MRCF5 (*B00, *D00)

Mat PET Fiber
Dim 1686 × 280 × 10 mm
 66.4 × 11 × 0.4 in
MOQ 40



Line 1500 Rectangle / Classroom Modesty Panel

CB_MRBE5 (*B00, *D00)

Mat PET Fiber
Dim 1386 × 280 × 10 mm
 54.6 × 11 × 0.4 in
MOQ 40

Modesty Panel



B00
Black



D00
Light Grey

Line Cable Management

Line Table power units have been designed to fit discreetly beneath tables, with a subtle cable management sleeve to reduce trip hazards and unsightly wires. Equipped with male and female sockets, each unit can be daisy-chained together, with magnetic clips provided to channel cables discreetly along table frames. Intelligently designed USB-A and USB-C outlets for mobile and laptop charging may be toggled in and out and replaced without affecting adjacent sockets.

Available in North American, EU (Schuko), UK/IRL, and Japanese sockets as standard. Other regional sockets available upon request.



Line Under Desk Power Set

CB_PSUUK

MOQ 1
Note 2 plugs, A+C USB port
 Includes 1 × 1.5 Metres cable, 1 × cable sleeve

CB_PDUK

MOQ 1
Note 2 plugs, A+C USB port
 Includes 1 × daisy chain cable, 5 × magnetic clips.
 Available in regional options



Line Cable Management Sleeve

CB_CAAA6B00

Mat Rigid UPVC
Dim 57 × 27 × 658 mm
 2.2 × 1.1 × 25.9 in
MOQ 1

Materials and Colours

Line Table tops are made from HPL with a durable Reef edge; table legs are available in complementing colours. Craster recommends the material and colour selection below. Bespoke options are available upon request.

Our standard top comes as Erable and Black (B01). For bespoke colours, a minimum order quantity may apply.

Table Tops and Edge



B11
Tobacco + Black



B13
Light Walnut + Black



D15
Acacia + Grey



B42
Dark Marble + Black



D45
White Marble + Grey



B01
Érable Wenge + Black

Legs



B00
Black



D00
Grey

Modesty Panel



B00
Black



D00
Light Grey

Line 1800 Rectangle—B11 Tobacco + Black



Line 1500 Rectangle—B13 Light Walnut + Black



Line 1800 Classroom—D15 Acacia + Grey



Line 1500 Classroom—B42 Dark Marble + Black



Line 1800 Trapezoid—D45 White Marble + Grey



Line 1500 Trapezoid—B01 Érable Wenge + Black



Line 1800 Half Round—B11 Tobacco + Black



Line 1800 Rectangle—B13 Light Walnut + Black



Line Trolleys

Line Table Trolleys conveniently store eight tops and legs, enabling the Line system's convenient transport before and after changeover.



Line 1800 Rectangle / Classroom Trolley

CB_SRCA3B00

Mat Mild Steel
Dim 2339 × 550 × 1210 mm
 92 × 21.6 × 47.6 in
MOQ 2
Note Each Trolley can fit 8 tops and legs



Line 1800 Trapezoid / Half Round Trolley

CB_STCF3B00

Mat Mild Steel
Dim 2158 × 550 × 1385 mm
 84.9 × 21.6 × 54.5 in
MOQ 2
Note Each Trolley can fit 8 tops and legs



Line 1500 Rectangle / Classroom Trolley

CB_SRBA3B00

Mat Mild Steel
Dim 1977 × 550 × 1060 mm
 77.8 × 21.6 × 41.7 in
MOQ 2
Note Each Trolley can fit 8 tops and legs



Line 1500 Trapezoid / Half Round Trolley

CB_STBE3B00

Mat Mild Steel
Dim 1823 × 550 × 1310 mm
 71.8 × 21.6 × 51.6 in
MOQ 2
Note Each Trolley can fit 8 tops and legs



Link

Introducing **Link**, a sleek, versatile events table for ambitious event space designs.

Supports: Full F&B services, presentations, and seating areas, combining front-of-house elegance with back-of-house functionality.

Complements: The Line system for a seamless look across spaces.

Features: Slender obround legs with a central folding mechanism for easy storage and setup in three heights.

Shapes: Available in rectangular, round, and square.

Customisation: Linenless design with durable HPL or toughened glass tops for flexible, hygiene-conscious, wipe-clean solutions. Choose table shape, top material/finish, and leg height (short, medium, tall).

Nesting arrangements: Mix and match different heights for versatile setups.

Trolleys: Store up to six tops and legs, ensuring safe transport and storage of glass and HPL tops with excellent stacking density and craftsmanship.







Discover more

Link Table System

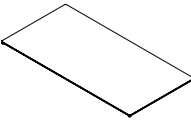
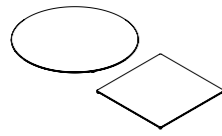
The innovative Link Table System blends front-of-house poise with back-of-house functionality in a beautiful concept. Available in three shapes—rectangular, round and square—Link tables can be combined with different height legs to create nesting arrangements.

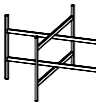
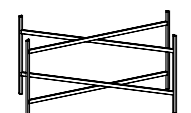
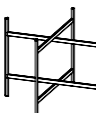
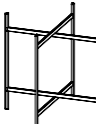
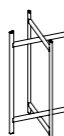
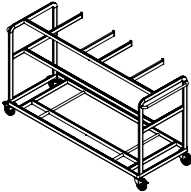
Select a shape and material for the top and finish by choosing a leg height (short, medium, tall). The Link 600 series is an ideal cocktail table footprint. Note that 600 series tops and legs do not operate with other Link products.

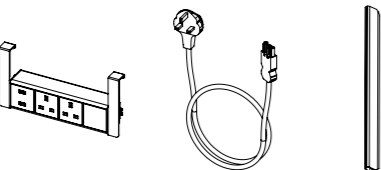
	800 Range	600 Range	
Table Tops	1600 × 800 mm 63 × 31.5 in  800 Rectangle	1130ø / 800 × 800 mm 44.5ø / 31.5 × 31.5 in  800 Round / Square	600ø × 25 mm 23.6ø × 1 in  600 Round
Short Legs	 800 Short		
Medium Legs	  800 Medium		
Tall Legs	 800 Tall		 600 Tall
Storage Trolleys	  800 Round / Square		
Cable Management			



Link Reef Edge Table Tops

A highly resistant innovation, the Reef table top edge ensures longevity in the aesthetic and operation of conference and events ranges. The protective Reef edge offers the perfect solution for frequent set-up, breakdown, and back-of-house storage. Combined with laminate tops, Reef edges provide an unparalleled ease of care.

Our other HPL finishes from Line are available for Rise and Link, dependent on order quantity.



Link Reef Edge Square Table Top

CB_TSQ800 (*B11, *D41)
Mat HPL, Reef Edge
Dim 800 × 800 × 22 mm
 31.5 × 31.5 × 0.9 in
MOQ 10



Link Reef Edge Round Table Top

CB_TRO800 (*B11, *D41)
Mat HPL, Reef Edge
Dim 1130ø × 22 mm
 44.5ø × 0.9 in
MOQ 10

CB_TRO400 (*B42, *B11)

Mat HPL, Reef Edge
Dim 600ø × 25 mm
 23.6ø × 1 in
MOQ 10



Reef Edge Table Tops



B11

Tobacco + Black



B42

Dark Marble + Black

Link Glass Table Tops

Our toughened glass tops are available in clear or grey glass.



Link Glass Rectangle Table Top

CB_TRE800 (*50, *20)
Mat Glass
Dim 800 × 1600 × 22 mm
 31.5 × 63 × 0.9 in
MOQ 10



Link Glass Square Table Top

CB_TSQ800 (*50, *20)
Mat Glass
Dim 800 × 800 × 22 mm
 31.5 × 31.5 × 0.9 in
MOQ 10

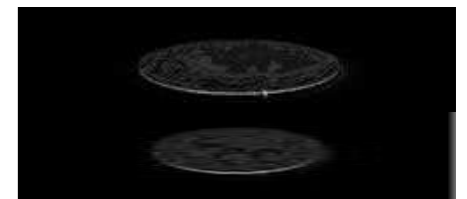

Link Glass Round Table Top

CB_TRO800 (*50, *20)
Mat Glass
Dim 1130ø × 22 mm
 44.5ø × 0.9 in
MOQ 10

CB_TRO400 (*50, *20)

Mat Glass
Dim 600ø × 25 mm
 23.6ø × 1 in
MOQ 10



Glass Table Tops



50
Grey



20
Clear



Link Table Legs

With a slender elliptical leg profile and central folding mechanism, Link Table Legs have been intelligently designed to demount quickly for easy storage while retaining an exceptional display front-of-house.

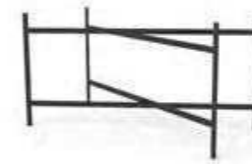

Link Rectangle Medium Table Leg

CB_LRE890B00

Mat	Powder Coated Steel	
Dim	Open:	Folded:
	1600 × 800 × 880 mm	1782 × 42 × 880 mm
	63 × 31.5 × 34.6 in	70.1 × 1.7 × 34.6 in
MOQ	10	



Link Square / Round Tall Table Leg

CB_LSQ811B00

Mat	Powder Coated Steel	
Dim	Open:	Folded:
	800 × 800 × 1080 mm	1131 × 42 × 1080 mm
	31.5 × 31.5 × 42.5 in	44.5 × 1.7 × 42.5 in
MOQ	10	



Link Square / Round Medium Table Leg

CB_LSQ890B00

Mat	Powder Coated Steel	
Dim	Open:	Folded:
	800 × 800 × 880 mm	1131 × 42 × 880 mm
	31.5 × 31.5 × 34.6 in	44.5 × 1.7 × 34.6 in
MOQ	10	



Link Square / Round Short Table Leg

CB_LSQ874B00

Mat	Powder Coated Steel	
Dim	Open:	Folded:
	800 × 800 × 720 mm	1131 × 42 × 720 mm
	31.5 × 31.5 × 28.3 in	44.5 × 1.7 × 28.3 in
MOQ	10	



Link Round Tall Cocktail Table Leg

CB_LSQ411B00

Mat	Powder Coated Steel	
Dim	Open:	Folded:
	430 × 430 × 1080 mm	600 × 42 × 1080 mm
	16.9 × 16.9 × 42.5 in	23.6 × 1.7 × 42.5 in
MOQ	10	



Legs



B00
Black

Link Trolleys



Link Rectangle Trolley

CB_SRE800B00

Mat	Powder Coated Steel	
Dim	2105 × 755 × 1185 mm	
	82.9 × 29.7 × 46.6 in	
MOQ	1	
Note	Each Trolley can fit 5 tops and legs	



Link Square / Round Trolley

CB_SSQ800B00

Mat	Powder Coated Steel	
Dim	1305 × 755 × 1185 mm	
	51.4 × 29.7 × 46.6 in	
MOQ	1	
Note	Each Trolley can fit 5 tops and legs	

Rise

Introducing **Rise**, designed for modular, easy-to-assemble service with a focus on beauty and efficiency.

Universal locating system: Mix and match any table top and legs to create tailored display solutions.

Leg finishes: Available in natural, white, painted black oak, stainless, or black steel.

Interchangeable tops: HPL table tops with protective Reef edges for durability and easy cleaning.

Customisation: Choose size (800 or 700 series), top shape and material, leg height (short, medium, tall), and leg finish.

Ease of use: Designed for single-person set-up, breakdown, and storage.

Rise trolleys: Store up to 10 elements, providing high-density, ergonomic storage and transport solutions.









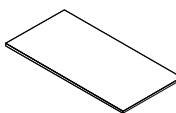
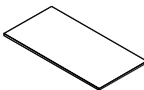
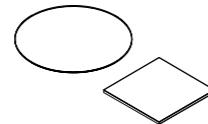
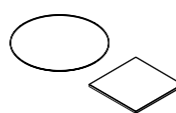
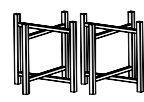
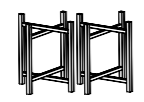
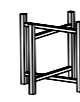

Discover more

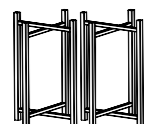
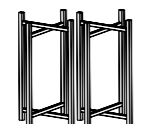
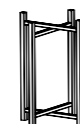
Rise Table System

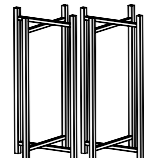
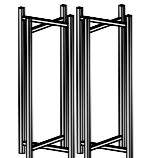
Using a universal locating system, the Rise Table System allows you to mix and match any top or legs to create the perfect solution for your buffet.

Select a size series (800 or 700), then select a shape and material for the top and finish by choosing a leg height (short, medium, tall) and a leg finish (stained wenge, painted black ash, and stainless or black steel).

	800 Double	700 Double	800	700
Table Tops	 800 Double Top	 700 Double Top	 800 Top	 700 Top
Short Legs	 800 Short	 700 Short	 800 Short	 700 Short
Medium Legs	 800 Medium	 700 Medium	 800 Medium	 700 Medium
Tall Legs	 800 Tall	 700 Tall	 800 Tall	 700 Tall
Storage Trolleys				



Rise Reef Edge Table Tops

The aesthetic and longevity of the Rise System is ensured by the hard-wearing Reef edge, which offers the perfect solution for frequent set-up, breakdown, and back-of-house storage. Combined with laminate tops, Reef edges offer wipe-clean ease.

Our other HPL finishes from Line are available for Rise and Link, dependent on order quantity.



Rise Reef Edge Rectangle Table Top

CB_UT8140
Mat Érable Wenge HPL, Black Reef Edge
MOQ 10

CB_UT81 (*B11, *B42, *D45)

Mat HPL, Reef Edge
MOQ 10
Dim 800 × 1600 × 25 mm
 31.5 × 63 × 1 in
Note Fits: 800 products

CB_UT71 (*B11, *B42, *D45, *40)

Mat HPL, Reef Edge
Dim 700 × 1400 × 25 mm
 27.6 × 65.1 × 1 in
MOQ 10
Note Fits: 700 products



Rise Reef Edge Square Table Top

CB_UT8040
Mat Érable Wenge HPL, Black Reef Edge
MOQ 1

CB_UT80 (*B11, *B42, *D45)

Mat HPL, Reef Edge
MOQ 10
Dim 800 × 800 × 25 mm
 31.5 × 31.5 × 1 in
Note Fits: 800 products

CB_UT70 (*B11, *B42, *D45, *40)

Mat HPL, Reef Edge
Dim 700 × 700 × 25 mm
 27.6 × 27.6 × 1 in
MOQ 10
Note Fits: 700 products



Rise Reef Edge Round Table Top

CB_UT83 (*B11, *B42, *D45, *40)

Mat HPL, Reef Edge
Dim 1130ø × 25 mm
 44ø × 1 in
MOQ 10
Note Fits: 800 products

CB_UT73 (*B11, *B42, *D45, *40)

Mat HPL, Reef Edge
Dim 990ø × 25 mm
 39ø × 1 in
MOQ 10
Note Fits: 700 products

Rise Veneer Table Tops

Formed of layers of oak veneer and stained to a dark wenge with solid hardwood edging, Rise Veneer Table Tops form an elegant solution for the Rise system.



Rise Veneer Rectangle Table Top

CB_UT8101
Mat Veneer
Dim 800 × 1600 × 25 mm
 31.5 × 63 × 1 in
MOQ 10
Note Fits: 800 products

CB_UT7101

Mat Veneer
Dim 700 × 1400 × 25 mm
 27.6 × 55.1 × 1 in
MOQ 30
Note Fits: 700 products



Rise Veneer Square Table Top

CB_UT8001
Mat Veneer
Dim 800 × 800 × 25 mm
 31.5 × 31.5 × 1 in
MOQ 30
Note Fits: 800 products

CB_UT7001

Mat Veneer
Dim 700 × 700 × 25 mm
 27.6 × 27.6 × 1 in
MOQ 30
Note Fits: 700 products

Table Tops and Edge



B11
Tobacco + Black



B42
Dark Marble + Black



D45
White Marble + Grey



B01
Érable Wenge + Black

Rise Glass Table Tops

Toughened glass tops enhance the hard-wearing features of Rise. Available in clear, frosted, or grey glass.



Rise Glass Rectangle Table Top

CB_UT81 (*50, *30, *20)
Mat Glass
Dim 800 × 1600 × 22 mm
 31.5 × 63 × 0.9 in
MOQ 5
Note Fits: 800 products

CB_UT71

CB_UT71 (*50, *30, *20)
Mat Glass
Dim 700 × 1400 × 22 mm
 27.5 × 55.1 × 0.9 in
MOQ 5
Note Fits: 700 products



Rise Glass Square Table Top

CB_UT8020
Mat Clear Glass
MOQ 1
CB_UT80 (*50, *30)
Mat Glass
MOQ 5
Dim 800 × 800 × 22 mm
 31.5 × 31.5 × 0.9 in
Note Fits: 800 products

CB_UT70

CB_UT70 (*50, *30, *20)
Mat Glass
Dim 700 × 700 × 22 mm
 27.5 × 27.6 × 0.9 in
MOQ 5
Note Fits: 700 products



Rise Glass Round Table Top

CB_UT83 (*50, *30, *20)
Mat Glass
Dim 1130ø × 22 mm
 44.5ø × 0.9 in
MOQ 5
Note Fits: 800 products
CB_UT73 (*50, *30, *20)
Mat Glass
Dim 990ø × 22 mm
 39ø × 0.9 in
MOQ 5
Note Fits: 700 products

Glass Table Tops



50
Grey



30
Frosted



20
Clear

Rise Table Legs

Rise Table Legs are available in three heights, with material options of stained wenge, painted black ash, and stainless or black steel.

Link trolleys are compatible with Rise system, see page 177 for options.



Rise 800 Tall Table Leg

CB_UL8401
Mat Stained Wenge
MOQ 30
CB_UL8410
Mat Stainless Steel
MOQ 30
CB_UL8420
Mat Black Powder Coated Steel
MOQ 30
Dim **Open:** 787 × 787 × 1090 mm
 31 × 31 × 42.9 in
Folded: 826 × 73/95 × 1090 mm
 32.5 × 2.9/3.7 × 42.9 in
Note Fits: 800 products



Rise 800 Medium Table Leg

CB_UL8201
Mat Stained Wenge
MOQ 30
CB_UL8210
Mat Stainless Steel
MOQ 30
CB_UL8220
Mat Black Powder Coated Steel
MOQ 30
Dim **Open:** 787 × 787 × 890 mm
 31 × 31 × 35 in
Folded: 826 × 73/95 × 890 mm
 32.5 × 2.9/3.7 × 35 in
Note Fits: 800 products



Rise 800 Short Table Leg

CB_UL8101
Mat Stained Wenge
MOQ 30
CB_UL8110
Mat Stainless Steel
MOQ 30
CB_UL8120
Mat Black Powder Coated Steel
MOQ 1
Dim **Open:** 787 × 787 × 690 mm
 31 × 31 × 27.2 in
Folded: 826 × 73/95 × 690 mm
 32.5 × 2.9/3.7 × 27.2 in
Note Fits: 800 products



Rise 700 Tall Table Leg

CB_UL74 (*01, *10, *20)
Mat See options below
Dim **Open:** 696 × 696 × 1090 mm
 27.4 × 27.4 × 42.9 in
Folded: 734 × 73/95 × 1090 mm
 28.9 × 2.9/3.7 × 42.9 in
MOQ 30
Note Fits: 700 products



Rise 700 Medium Table Leg

CB_UL72 (*01, *10, *20)
Mat See options below
Dim **Open:** 696 × 696 × 890 mm
 27.4 × 27.4 × 35 in
Folded: 734 × 73/95 × 890 mm
 28.9 × 2.9/3.7 × 35 in
MOQ 30
Note Fits: 700 products



Rise 700 Short Table Leg

CB_UL71 (*01, *10, *20)
Mat See options below
Dim **Open:** 696 × 696 × 690 mm
 27.4 × 27.4 × 27.2 in
Folded: 734 × 73/95 × 690 mm
 28.9 × 2.9/3.7 × 27.2 in
MOQ 30
Note Fits: 700 products

Legs



01
Stained Wenge



10
Stainless Steel



20
Powder Coated Steel,
Black

Bedroom



Tea Service

Simple, elegant hospitality tea and coffee presentation pieces in lavish materials.



Walnut Three-Piece Luxury Tea Set

TA_LTSFW

Mat	Walnut, Lacquered		
Dim	Large Tray: 427 × 292 × 25 mm 16.8 × 11.5 × 1 in	Small Tray: 280 × 162 × 25 mm 11 × 6.4 × 1 in	Tea Caddy: 280 × 77 × 87 mm 11 × 3 × 3.4 in
MOQ	1		



Large Walnut Tea Tray

TA_LTSFW.1

Mat	Walnut, Lacquered
Dim	427 × 292 × 25 mm 16.8 × 11.5 × 1 in
MOQ	1



Small Walnut Tea Tray

TA_LTSFW.2

Mat	Walnut, Lacquered
Dim	280 × 162 × 25 mm 11 × 6.4 × 1 in
MOQ	1



Walnut Tea Caddy

TA_LTSFW.3

Mat	Walnut, Lacquered
Dim	280 × 77 × 87 mm 11 × 3 × 3.4 in
MOQ	1



Amenities Presentation

Craster's select range of exquisite products for the bedroom and bathroom environment. Strong, durable materials mean these products can withstand moisture-rich environments.



Walnut Tissue Box

AP_364_W
Mat Walnut, Lacquered
Dim 132 x 132 x 137 mm
 5.2 x 5.2 x 5.4 in
MOQ 1



Faux Leather Tissue Box

AP_367_H
Mat Espresso Brown Faux Leather / Suede inner
Dim 138 x 138 x 140 mm
 5.4 x 5.4 x 5.5 in
MOQ 100



Stainless Steel Tissue Box

AP_317_J 
Mat Stainless Steel
Dim 122 x 122 x 135 mm
 4.8 x 4.8 x 5.3 in
MOQ 504



Bedroom Faux Leather Shoe Box

AP_LB003
Mat Espresso Brown Faux Leather / Suede inner
Dim 372 x 236 x 146 mm
 14.65 x 9.29 x 5.76 in
MOQ 20



Faux Leather Laundry Box

AP_LB005
Mat Espresso Brown Faux Leather / Suede inner
Dim 380 x 300 x 130 mm
 14.9 x 11.8 x 5.1 in
MOQ 50



Faux Leather Box

AP_LB004 
Mat Espresso Brown Faux Leather / Suede inner
Dim 200 x 265 x 55 mm
 7.8 x 10.4 x 2.2 in
MOQ 50
Note Customisable inserts available



Faux Leather Waste Bin

AP_367_G 
Mat Espresso Brown Faux Leather with Stainless Steel rim and removable fire resistant metal liner
Dim 209 x 209 x 257 mm
 8.2 x 8.2 x 10.1 in
MOQ 25



Waste Bin with Lid - Stainless Steel - NO LINER

AP_SS002.1
Mat Stainless Steel
Dim 175 x 175 x 220 mm
 6.89 x 6.89 x 8.66 in
MOQ 1



Stainless Steel Soap Dish

AP_317_K
Mat Stainless Steel
Dim 100 x 60 x 20 mm
 3.9 x 2.4 x 0.8 in
MOQ 540

Luggage Racks

Luggage racks combine rigid construction and beautifully finished materials. The integrated backboard prevents luggage from damaging the walls.



Shaker Bins and Storage

Made from fine Scandinavian Aeropyl in the tradition of 19th-century American Shaker community, the Shaker range adds a touch of luxury to the bedroom or bathroom.



Bedroom Luggage Rack with Backboard

SR_LUGB0	SR_LUGBW	SR_LUGBBLK
Mat Oak	Mat Walnut	Mat Black
Dim 655 x 417 x 530 mm 25.8 x 16.4 x 20.9 in		
MOQ 40		
Note Materials available depending on order quantity		

Bedroom Luggage Rack

SR_LUGO	SR_LUGW	SR_LUGBLK
Mat Oak	Mat Walnut	Mat Black
Dim 655 x 417 x 466 mm 25.8 x 16.4 x 18.3 in		
MOQ 40		
Note Materials available depending on order quantity		

Materials and Colours



Oak



Walnut



Black



Shaker Large Luxury Waste Bin

SH_LWBW
Mat Birch Stained Walnut
MOQ 1
Dim 325 x 247 x 305 mm 12.7 x 9.7 x 12 in



Shaker Small Luxury Waste Bin

SH_LW001	SH_LW002
Mat Birch Stained Walnut	Mat Birch Stained Black
MOQ 60	MOQ 60
Dim 240 x 180 x 225 mm 9.4 x 7.1 x 8.8 in	

Materials and Colours



Walnut



Black





craster



To discover more, visit us online
or contact the team.

Craster Ltd.
Great Western Studios
65 Alfred Road
London W2 5EU

(UK) +44 (0)203 004 4750
(USA) +1 732 543 7862
info@craster.com
www.craster.com



Please recycle this Craster publication.

- Separate cover and binding from pages before recycling. Pages are widely recyclable.
- Consult your local recycling guidelines for cover and binding.

PRINTED ON FSC CERTIFIED PAPER

