

**2025/26**

# **MULTISERVICE HOSPITALITY EQUIPMENT**

**Attrezzature complete per l'ospitalità**



# Guida alla Lettura

## IT

Forcar Multiservice è il catalogo di Fimar Group dedicato a tutti quegli articoli per l'ospitalità non solo del mondo Ho.Re.Ca. ma anche a scuole, ospedali, strutture sanitarie e militari.

Fa parte di questo catalogo anche tutta la nostra linea dedicata all'acciaio Inox dove potrete trovare tavoli, lavelli, armadi e rubinetteria tutti rigorosamente Made in Italy.

Dal 1994 fanno parte del brand Forcar: carrelli e mobili di servizio, espositori termici, elementi riscaldanti e di mantenimento, articoli per la macelleria, teglie, bacinelle e cassette pizza, articoli per la prima colazione e per il buffet, ceppi e sterilizza coltelli.

Come ad ogni nuova edizione la nostra proposta diventa sempre più ricca, cerca il bollino novità e scopri le nostre nuove vetrine riscaldate, i carrelli porta teglie ed infine la linea le cassettiere per i tavoli inox.



Cerca il bollino novità e scopri le tutte!

Look for the new sticker and discover them all!

Cherchez la vignette de la nouveauté et découvrez-les tous!

Achten sie auf den neuheitsaufkleber und entdecken sie sie alle!

## EN

Forcar Multiservice is the Fimar Group catalogue dedicated to hospitality products for the Ho.Re.Ca. sector, as well as schools, hospitals, healthcare facilities and the military.

This catalogue also features our entire stainless steel range, including tables, sinks, cabinets, taps, and fittings, all of which are rigorously Made in Italy.

Since 1994, the Forcar brand has included trolleys and service furniture, thermal display units, heating and heat-preserving elements, butcher's items, pans, basins, pizza containers, breakfast and buffet items, chopping blocks, and knife sterilisers.

With each new edition, our range grows, so look out for the tag to discover our new heated display cabinets, tray trolleys, and finally, our stainless steel table drawer range.



FR

Le catalogue Forcar Multiservice du groupe Fimar est consacré à tous les articles d'accueil, pas seulement pour le secteur Ho.Re.Ca., mais aussi pour les écoles, les hôpitaux, les établissements de santé et les installations militaires.

Il comprend également toute la gamme en inox, avec des tables, des éviers, des armoires, des robinets et des raccords, tous rigoureusement fabriqués en Italie.

Depuis 1994, la marque Forcar propose des chariots et meubles de service, des présentoirs thermiques, des éléments de chauffage et de maintien, des articles de boucherie, des poêles, des bassines et des bacs à pizza, des articles de petit-déjeuner et de buffet, des bûches et des stérilisateurs de couteaux.

Comme à chaque nouvelle édition, notre offre s'étoffe. Cherchez l'étiquette « nouveauté » pour découvrir nos nouvelles vitrines chauffantes, nos chariots à plateaux et notre ligne de tiroirs de table en acier inox.

DE

Forcar Multiservice ist der Katalog der Fimar-Gruppe, der sich mit allen Artikeln für das Gastgewerbe befasst, nicht nur für die Ho.Re.Ca.-Welt, sondern auch für Schulen, Krankenhäuser, das Gesundheitswesen und militärische Einrichtungen.

Zu diesem Katalog gehört auch unsere gesamte Edelstahl-Linie, in der Sie Tische, Spülbecken, Schränke und Armaturen finden, die alle streng in Italien hergestellt werden.

Seit 1994 gehören zur Marke Forcar: Wagen und Servicemöbel, Wärmeschränke, Heiz- und Aufbewahrungselemente, Artikel für die Metzgerei, Pfannen, Schüsseln und Pizzabehältern, Frühstücks- und Buffetartikel, Holzblöcke und Messer-Sterilisationsgeräte.

Mit jeder neuen Ausgabe wird unser Angebot reicher und reicher, achten Sie auf den Neuheutenaufkleber und entdecken Sie unsere neuen Wärmeschränke, Tablettwagen und schließlich die Linie der Tischschubladen aus Edelstahl.

NEUTRO INOX  
STEEL FURNITURE

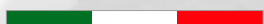

MADE IN ITALY

# Consigli sulla pulizia e la cura di macchinari in acciaio inox

IT

Una corretta pulizia e manutenzione dell'acciaio inox su apparecchiature professionali contribuirà a mantenere il macchinario efficiente e in ottime condizioni di igiene garantendone un prolungato utilizzo.

L'acciaio inossidabile (o inox) è così chiamato per la sua alta resistenza alla corrosione; tuttavia il sottile strato protettivo che riveste il metallo, può essere danneggiato meccanicamente o chimicamente (ad esempio con graffi, incisioni, tagli o l'utilizzo di prodotti corrosivi vedi tabella di seguito).

Alcuni suggerimenti per mantenere inalterato l'acciaio inox:

1. Utilizza una soluzione di detergente delicato mescolando acqua tiepida e un detergente neutro. Evita di utilizzare detergenti aggressivi o abrasivi, in quanto potrebbero danneggiare la superficie in acciaio inox.
2. Immergi un panno morbido o una spugna nella soluzione detergente e pulisci delicatamente la superficie dell'acciaio inox. Assicurati di seguire il grano dell'acciaio inox per evitare graffi sulla superficie.
3. Per le zone più ostinate o per eventuali macchie, puoi utilizzare un detergente specifico per l'acciaio inox ad uso alimentare (vedi la sezione dedicata alla pulizia delle macchine sul catalogo Fimar).
4. Dopo aver rimosso lo sporco, risciacqua bene il macchinario con acqua pulita per eliminare completamente i residui del detergente.
5. Asciuga la superficie con un panno pulito e asciutto per evitare la formazione di macchie d'acqua.
6. Oltre alla pulizia regolare, è consigliabile effettuare una manutenzione periodica sulla macchina refrigerante per assicurarsi che funzioni in modo ottimale. Controlla i filtri, le guarnizioni e le condizioni generali del macchinario.
7. Durante la pulizia, presta attenzione a non danneggiare le parti elettriche o meccaniche del macchinario. Si consiglia di consultare sempre un tecnico specializzato o un servizio di manutenzione autorizzato.

EN

Proper cleaning and maintenance of stainless steel on professional equipment will help to keep the machinery efficient and in excellent hygienic condition and ensure its continued use.

Stainless steel is named for its high resistance to corrosion; however, the thin protective layer that covers the metal can be damaged mechanically or chemically (e.g. by scratches, incisions, cuts or the use of corrosive products see table below).

Some tips for maintaining stainless steel:

1. Use a mild detergent solution by mixing warm water and a neutral detergent. Avoid using harsh or abrasive cleaners, as they may damage the stainless steel surface.
2. Dip a soft cloth or sponge into the cleaning solution and gently wipe the stainless steel surface. Be sure to follow the grain of the stainless steel to avoid scratches on the surface.
3. For stubborn areas or any stains, you can use a detergent specifically for stainless steel for food use (see the section on machine cleaning in the Fimar catalogue).
4. After removing the dirt, rinse the machine well with clean water to completely remove any residues of the detergent.
5. Dry the surface with a clean, dry cloth to prevent water spots from forming.
6. In addition to regular cleaning, it is advisable to carry out periodic maintenance on refrigerating equipment to ensure that it functions optimally. Check the filters, seals and general condition of the equipment.
7. When cleaning, take care not to damage the electrical or mechanical parts of the machine. Always consult a specialised technician or an authorised maintenance service.

## FR

Un nettoyage et un entretien adéquats de l'acier inox sur les équipements professionnels permettront de maintenir l'efficacité et l'hygiène des machines et d'assurer leur utilisation continue.

L'acier inoxydable (ou inox) est appelé ainsi en raison de sa grande résistance à la corrosion ; toutefois, la fine membrane protectrice qui recouvre le métal peut être endommagée mécaniquement ou chimiquement (par exemple, par des rayures, des incisions, des coupures ou l'utilisation de produits corrosifs - voir le tableau ci-dessous).

Quelques conseils pour l'entretien de l'acier inox:

1. Utilisez une solution détergente douce en mélangeant de l'eau tiède et un détergent neutre. Évitez d'utiliser des nettoyeurs agressifs ou abrasifs, car ils risquent d'endommager la surface de l'acier inoxydable.
2. Trempez un chiffon doux ou une éponge dans la solution de nettoyage et essuyez délicatement la surface en acier inox. Veillez à suivre le grain de l'acier inox afin d'éviter les rayures sur la surface.
3. Pour les zones tenaces ou les taches, vous pouvez utiliser un détergent spécifique pour l'acier inoxydable à usage alimentaire (voir la section sur le nettoyage des appareils dans le catalogue Fimar).
4. Après avoir éliminé la saleté, rincez bien la machine à l'eau claire pour éliminer complètement les résidus de détergent.
5. Séchez la surface avec un chiffon propre et sec pour éviter la formation de taches d'eau.
6. Outre le nettoyage régulier, il est conseillé d'effectuer un entretien périodique de la machine frigorifique pour garantir son fonctionnement optimal. Vérifiez les filtres, les joints et l'état général de la machine.
7. Lors du nettoyage, veillez à ne pas endommager les parties électriques ou mécaniques de la machine. Consultez toujours un technicien spécialisé ou un service d'entretien autorisé.

## DE

Die ordnungsgemäße Reinigung und Pflege von Edelstahl bei professionellen Geräten trägt dazu bei, die Effizienz und Hygiene der Maschinen zu erhalten und ihre weitere Nutzung zu gewährleisten.

Die dünne Schutzschicht, die das Metall bedeckt, kann jedoch mechanisch oder chemisch beschädigt werden (z. B. durch Kratzer, Einschnitte, Schnitte oder die Verwendung von ätzenden Produkten, siehe Tabelle unten).

Einige Tipps zur Pflege von Edelstahl:

1. Verwenden Sie eine milde Reinigungslösung, indem Sie lauwarmes Wasser und ein neutrales Reinigungsmittel mischen. Verwenden Sie keine scharfen oder scheuernden Reinigungsmittel, da diese die Edelstahloberfläche beschädigen können.
2. Tauchen Sie ein weiches Tuch oder einen Schwamm in die Reinigungslösung und wischen Sie die Edelstahloberfläche vorsichtig ab. Achten Sie darauf, der Textur des Edelstahls zu folgen, um Kratzer auf der Oberfläche zu vermeiden.
3. Für hartnäckige Stellen oder Flecken können Sie ein spezielles Reinigungsmittel für Edelstahl für den Lebensmittelbereich verwenden (siehe den Abschnitt über die Reinigung von Geräten im Fimar-Katalog).
4. Spülen Sie die Maschine nach dem Entfernen der Verschmutzung gut mit klarem Wasser ab, um eventuelle Rückstände des Reinigungsmittels vollständig zu entfernen.
5. Trocknen Sie die Oberfläche mit einem sauberen, trockenen Tuch ab, um die Bildung von Wasserflecken zu vermeiden.
6. Neben der regelmäßigen Reinigung ist es ratsam, die Kühlgräte regelmäßig zu warten, um einen optimalen Betrieb zu gewährleisten. Überprüfen Sie die Filter, Dichtungen und den allgemeinen Zustand der Maschine.
7. Achten Sie bei der Reinigung darauf, dass die elektrischen oder mechanischen Teile der Maschine nicht beschädigt werden. Wenden Sie sich immer an einen Fachtechniker oder einen anerkannten Wartungsdienst.

# Schema reazione acciaio inox

SCHEMATIC REACTION OF STAINLESS STEEL  
SCHÉMA SYNTHÉTIQUE DE LA RÉACTION DE L'ACIER INOX  
ÜBERSICHTSDIAGRAMM DER REAKTION VON EDELSTAHL



In condizioni normali di uso non esisitono problemi di corrosione  
Under normal conditions of use there are no corrosion issues  
Dans des conditions normales d'utilisation, il n'y a pas de problèmes de corrosion  
Unter normalen einsatzbedingungen gibt es keine korrosionsprobleme



Possibilità di corrosione evidente, verificare attentamente le condizioni di impiego  
Risk of corrosion, carefully verify the conditions of use  
Risque de corrosion évident, vérifiez soigneusement les conditions d'utilisation  
Gefahr einer deutlichen korrosion, überprüfen sie sorgfältig die nutzungsbedingungen





















Sicuri fenomeni corrosivi - non usare  
Certain corrosive reactions - do not use  
Certaines reactions corrosives - ne pas utiliser  
Bestimmte korrosionsreaktionen - nicht verwenden

SOSTANZA / SUBSTANCES / SUBSTANCES / SUBSTANZEN	
ACIDO CLORIDRICO (tutte le concentrazioni) HYDROCHLORIC ACID (all concentrations) ACIDE CHLORHYDRIQUE (toutes les concentrations) SALZSÄURE (alle Konzentrationen)	
ACIDO FLUORIDRICO (tutte le concentrazioni) HYDROFLUORIC ACID (all concentrations) ACIDE FLUORYDRIQUE (toutes les concentrations) FLUORWASSERSTOFFSÄURE (alle Konzentrationen)	
ACIDO MURIATICO (cloridrico commerciale) MURIATIC ACID (commercial hydrochloric) ACIDE MURIATIQUE (acide chlorhydrique dans le commerce) CHLORWASSERSTOFF (handels blische Salzsäure)	
ACIDO NITRICO fino a 10°C - 80°C NITRIC ACID up to 10°C - 80°C ACIDE NITRIQUE jusqu' 10°C - 80°C SALPETERSÄURE bis 10°C - 80°C	
ACIDO SOLFORICO FUMANTE (oleum) 50°C FUMING SULPHURIC ACID (oleum) 50°C ACIDE SULFURIQUE FUMANT (oleum) 50°C DAMPFENDE SCHWEFELSÄURE (Oleum) 50°C	
ACQUARAGIA TURPENTINE WHITE SPIRIT TERPENTIN	
ALCOOL ALCOHOL ALCOOL ALKOHOL	
BENZINA BENZENE ESSENCE BENZIN	
BICARBONATO DI SODIO (tutte le concentrazioni) SODIUM BICARBONATE (all concentrations) BICARBONATE DE SOUDE (toutes les concentrations) NATRIUMHYDROGENKARBONAT (alle Konzentrationen)	

SOSTANZA / SUBSTANCES / SUBSTANCES / SUBSTANZEN	
CANDEGGINA BLEACH EAU DE JAVEL CHLORBLEICHE	
CARBONATO DI SODIO (soda solvay) fino a 20% SODIUM CARBONATE (solvay soda) up to 20% SOUDE (sel solvay) jusqu'à 20% NATRIUMKARBONAT (Soda) bis 20%	
DILUENTI (acetone, toluolo, ecc.) THINNERS (acetone, toluol, etc.) DILUANTS (acetone, toluone, etc.) VERDUNNUNGSMITTEL (Aceton, Toluolo, usw.)	
GAS DI CLORO UMIDO DAMP CHLORINE GAS GAZ DE CHLORE HUMIDE FEUCHTES CHLORGAS	
SAPONE SOAP SAVON SEIFE	
SODA CAUSTICA fino a 20% CAUSTIC SODA up to 20% SOUDE CAUSTIQUE jusqu'à 20% ÄTZNATRON bis 20%	
SOLFATO DI RAME 10% COPPER SULPHATE 10% SULFATE DE CUIVRE 10% KUPFERSULFAT 10%	
SOLVENTI (trielina, benzolo, ecc.) SOLVENTS (triethylene, benzol, etc.) SOLVANTS (trichloroéthylène, benzene, etc.) LÖSUNGSMITTEL (Trichlorethylen, Benzol, usw.)	
VERNICI PAINTS VERNIS LACKE	

# Icone

ICONS  
ICÔNES  
SYMBÔLE

	IT	EN	FR	DE
	INFORMAZIONI	INFORMATION	INFORMATION	INFO
	NUMERO PIANI	NUMBER OF SHELVES	NOMBRE D'ÉTAGÈRES	STELLFLÄCHENANZAHL
	CARICO MASSIMO TOTALE	TOTAL MAXIMUM LOAD	TOTAL CHARGE MAXIMALE	GESAMT MAXIMALE BELASTUNG
	DIMENSIONI MACCHINA	MACHINE DIMENSIONS	DIMENSIONS DES MACHINES	MASCHINEN ABMESSUNGEN
	POTENZA	POWER	PUISSANCE	LEISTUNG
	PIASTRE/FUOCHI	PLATES/BURNERS	CUSINIÈRES/BRÛLEURS	KOCHFLÄCHEN/KOCHSTELLEN
	DIMENSIONI DEL PIANO DI LAVORO	DIMENSIONS OF THE WORKTOP	DIMENSIONS DU PLAN DE TRAVAIL	ABMESSUNGEN DER ARBEITSPLATTE
	NUMERO VASCHE	NUMBER OF BOWLS	NOMBRE DE CUVES	ANZAHL DER WANNEN
	ALIMENTAZIONE MONOFASE	SINGLE-PHASE POWER SUPPLY	ALIMENTATION MONOPHASÉE	EINPHASIGE STROMVERSORGUNG
	TEMPERATURA DI LAVORO	WORKING TEMPERATURE	TEMPÉRATURE DE FONCTIONNEMENT	BETRIEBSTEMPERATUR
	TIPO DI GAS	TYPE OF GAS	TYPE DE GAZ	GASTYP
	NUMERO DI TEGLIE / VASSOI	NUMBER OF TRAYS	NOMBRE DE PLAQUES / PLATEAUX	ANZAHL DER BLECHE / TRAYS
	NUMERO PIATTI	NUMBER OF PLATES	NOMBRE DE PLATS	ANZAHL DER TELLER
	CAPACITÀ NOMINALE	NOMINAL CAPACITY	CAPACITÉ NOMINALE	NENNKAPAZITÄT
	DIMENSIONI DI IMBALLO	PACKAGING DIMENSIONS	DIMENSIONS DES EMBALLAGES	VERPACKUNGSMASSE
	PESO NETTO	NET WEIGHT	POIDS NET	NETTOGEWICHT
	PESO LORDO	GROSS WEIGHT	POIDS BRUT	BRUTTOGEWICHT
	PREZZO	PRICE	PRIX	PREIS



# INDICE

INDEX  
TABLE DES  
MATIÈRES  
INHALT

CATEGORIE	IT	EN	FR	DE	
	CONDIZIONI GENERALI DI VENDITA	GENERAL SALES CONDITIONS	CONDITIONS GÉNÉRALES DE VENTE	ALLGEMEINE VERKAUFSBEDINGUNGEN	16
<b>CARRELLI E MOBILI DI SERVIZIO IN LEGNO</b>	CARRELLI GUÉRIDON	GUÉRIDON TROLLEYS	CHARIOTS GUÉRIDON	GUÉRIDON WAGEN	19
<b>WOODEN SERVICE TROLLEYS AND SERVING FURNITURE</b>	CARRELLI DI SERVIZIO IN LEGNO	WOODEN SERVICE TROLLEYS	CHARIOTS DE SERVICE EN BOIS	SERVIERWAGEN AUS HOLZ	20
<b>CHARIOTS ET MEUBLES DE SERVICE EN BOIS</b>	CARRELLI FLAMBÈ	FLAMBÈ TROLLEYS	CHARIOTS FLAMBÉS	FLAMBÉ WAGEN	30
<b>SERVIERWAGEN UND SERVICEMÖBEL AUS HOLZ</b>	MOBILI DI SERVIZIO IN LEGNO	WOODEN SERVING FURNITURE	MEUBLES DE SERVICE EN BOIS	SERVICEMÖBEL AUS HOLZ	32
<b>CARRELLI DI SERVIZIO IN ACCIAIO INOX AISI 304</b>	CARRELLI DI SERVIZIO IN ACCIAIO INOX	STAINLESS STEEL SERVICE TROLLEYS	CHARIOTS DE SERVICE EN ACIER INOX	SERVIERWAGEN AUS EDELSTAHL	38
<b>SERVICE TROLLEYS IN STAINLESS STEEL AISI 304</b>					
<b>CHARIOTS DE SERVICE EN ACIER INOX AISI 304</b>	CARRELLI DI SERVIZIO MULTIUSO IN PLASTICA	MULTIPURPOSE PLASTIC SERVICE TROLLEYS	CHARIOTS POLYVALENTE EN PLASTIQUE	MEHRZWECK-SERVICEWAGEN AUS KUNSTSTOFF	49
<b>SERVIERWAGEN AUS EDELSTAHL AISI 304</b>					
<b>CARRELLI ED ESPOSITORI REFRIGERATI E TERMICI IN LEGNO</b>	CARRELLI REFRIGERATI IN LEGNO	WOODEN REFRIGERATED TROLLEYS	CHARIOTS RÉFRIGÉRÉS EN BOIS	GEKÜHLTE SERVIERWAGEN AUS HOLZ	51
	ESPOSITORI REFRIGERATI IN LEGNO	WOODEN REFRIGERATED DISPLAYS	VITRINES RÉFRIGÉRÉES EN BOIS	GEKÜHLTE VITRINE AUS HOLZ	54
<b>WOODEN THERMAL AND REFRIGERATED TROLLEYS AND DISPLAYS</b>	CARRELLI TERMICI A BAGNOMARIA IN LEGNO	WOODEN BAIN-MARIE TROLLEYS	CHARIOTS CHAUDES BAIN-MARIE EN BOIS	BAIN-MARIE WAGEN AUS HOLZ	57
<b>CHARIOTS ET VITRINES RÉFRIGÉRÉS ET CHAUFFÉS EN BOIS</b>	ESPOSITORI TERMICI A BAGNOMARIA IN LEGNO	WOODEN HEATED BAIN-MARIE DISPLAYS	VITRINES CHAUDES BAIN-MARIE EN BOIS	BEHEIZTE BAIN-MARIE VITRINE AUS HOLZ	60
<b>GEKÜHLTE UND BEHEIZTE SERVIERWAGEN UND VITRINEN AUS HOLZ</b>	CARRELLO TERMICO, IDEALE PER BOLLITI E ARROSTI	HEATED TROLLEYS, IDEAL FOR BOILED AND ROASTED MEATS	CHARIOTS CHAUFFANTS, IDÉAUX POUR BOUILLIR ET RÔTIR	BEHEIZTE SERVIERWAGEN, IDEAL FÜR GEKOCHTES UND GEBRATENES FLEISCH	63
	MENSOLE IN LEGNO PER UNIONE	CONNECTION WOODEN SHELF	ÉTAGÈRES EN BOIS POUR RACCORDS	VERBINDUNGSREGALE AUS HOLZ	64
<b>CARRELLI REFRIGERATI E TERMICI, VASCHE DA INCASSO, IN ACCIAIO INOX</b>	VASCHE REFRIGERATE IN ACCIAIO INOX	STAINLESS STEEL REFRIGERATED BOWLS	CUVES RÉFRIGÉRÉES EN ACIER	KÜHLWANNEN AUS EDELSTAHL	67
<b>REFRIGERATED AND HEATED TROLLEYS, BUILT-IN BOWLS, MADE OF STAINLESS STEEL</b>	VASCHE TERMICHE A BAGNOMARIA IN ACCIAIO INOX	STAINLESS STEEL HEATED BAIN-MARIE BOWLS	CUVES BAIN-MARIE EN ACIER INOX	BAIN-MARIE HEIZWANNEN AUS EDELSTAHL	68
<b>CHARIOTS RÉFRIGÉRÉS ET CHAUFFÉS, BACS INTÉGRÉS, EN ACIER INOX</b>	CARRELLI REFRIGERATI IN ACCIAIO INOX	REFRIGERATED STAINLESS STEEL TROLLEYS	CHARIOTS RÉFRIGÉRÉS EN ACIER INOX	GEKÜHLTE SERVIERWAGEN AUS EDELSTAHL	69
<b>GEKÜHLTE UND BEHEIZTE SERVIERWAGEN, EINGEBAUTE BEHÄLTER, AUS EDELSTAHL</b>	CARRELLI TERMICI IN ACCIAIO INOX	HEATED STAINLESS STEEL TROLLEYS	CHARIOTS CHAUFFANTS EN ACIER INOX	BEHEIZTE SERVIERWAGEN AUS EDELSTAHL	70

CATEGORIE	IT	EN	FR	DE	
ELEMENTI RISCALDANTI E VETRINE NEUTRE	TAVOLE CALDE	HEATED TABLES	TABLES CHAUDES	BEHEIZTE TISCHE	79
	PIANI CALDI	HEATED TOPS	PLANS DE TRAVAIL CHAUDS	BEHEIZTE ARBEITSFLÄCHE	82
HEATING ELEMENTS AND NEUTRAL DISPLAYS	LAMPADE A RAGGI INFRAROSSI	INFRARED LAMPS	LAMPES INFRAROUGES	INFRAROT-LAMPEN	83
	VETRINE RISCALDANTI	HEATED DISPLAYS	VITRINES CHAUFFÉES	BEHEIZTE VITRINEN	87
ELÉMENTS CHAUFFANTS ET VITRINES NEUTRES	VETRINE NEUTRE	NEUTRAL DISPLAYS	VITRINES NEUTRES	NEUTRALE VITRINEN	88
	MOBILETTI SCALDAPIATTI	PLATES HEATING CABINETS	ARMOIRES CHAUFFE-PLATS	TELLERWÄRMER	91
HEIZELEMENTE UND NEUTRALE VITRINEN	VETRINE RISCALDANTI CON GRIGLIE	HEATED DISPLAY CASES WITH GRIDS	VITRINES CHAUFFÉES AVEC GRILLES	BEHEIZTE VITRINEN MIT GITTER	92
	CARRELLI PORTAVASSOI	TRAY TROLLEYS	CHARIOTS À PLATEAUX	SERVIERWAGEN FÜR PLATTEN	95
CARRELLI PER LA CUCINA	CARRELLI PORTATEGLIE	GASTRONOM PANS TROLLEYS	CHARIOTS À PLAQUES	SERVIERWAGEN FÜR GASTRONOMIE BLECHE	100
KITCHEN TROLLEYS	CARRELLI PORTATEGLIE RISCALDATI	HEATED CUPBOARD TROLLEYS	CHARIOTS CHAUFFÉS BACS	BEHEIZTE TRANSPORTBEHÄLTER	104
CHARIOTS POUR LA CUISINE	CARRELLI PORTATEGLIE REFRIGERATI	REFRIGERATED PANS TROLLEY	CHARIOTS POUR PLAQUES RÉFRIGÉRÉS	GEKÜHLTE SERVIERWAGEN	105
KÜCHENWAGEN	PORTAPIATTI DA BANCO, PORTAPIATTI DA PARETE E CARRELLI	TABLE TOP PLATE RACK, WALL PLATE RACK AND TROLLEYS	ÉTAGÈRE À ASSIETTES DE TABLE, PORTE-ASSIETTES À MURO ET CHARIOTS	TISCH-TELLERSTÄNDER, WANDTELLERHALTER. UND TELLERWAGEN	107
	CARRELLI PER TRASPORTO PIATTI	DISH TRANSPORT TROLLEYS	CHARIOTS POUR TRANSPORTER LA VAISSELLE	GESCHIRRWAGEN	109
CARRELLI PORTAPIATTI E CESTELLI	CARRELLI PORTAPIATTI ARMADIATI	CABINET PLATE TROLLEYS	CHARIOTS PORTE-ASSIETTES SUR ÉLÉMENT FERMÉ	TELLERWAGEN MIT SCHRANKELEMENT	110
	CARRELLI PORTAPIATTI RISCALDATI	HEATED PLATE STORAGE TROLLEYS	CHARIOTS CHAUFFÉS À ASSIETTES	BEHEIZTE TELLERWAGEN	111
PLATE AND BASKETS TROLLEYS	CARRELLI PORTAPIATTI REFRIGERATI	REFRIGERATED PLATE STORAGE TROLLEYS	CHARIOTS RÉFRIGÉRÉS À ASSIETTES	GEKÜHLTE TELLERWAGEN	112
CHARIOTS POUR PANIERS ET ASSIETTES	CARRELLI PORTAPIATTI PER TRASPORTO E RITIRO	PLATES TRANSPORT AND COLLECTION TROLLEYS	CHARIOTS DE COLLECTE, DE DISTRIBUTION ET DE STOCKAGE DE PLATEAUX	WAGEN ZUM SAMMELN, VERTEILEN UND LAGERN VON TABLETTS	113
SERVIERWAGEN FUER TELLER UND KÖRBE	SCOLAPIATTI E BICCHIERI	PLATE AND GLASSES DRAINER	ÉGOUTTOIR POUR VERRES ET ASSIETTES	HÄNGE-ABTROPFER FÜR TELLER UND GLÄSER	114
	CARRELLI PORTACESTELLI	BASKET TROLLEYS	CHARIOT À PANIERS	KORBWAGEN	116
CARRELLI PORTACASSETTE PER IMPASTI PIZZA	TROLLEY FOR PIZZA DOUGH CONTAINERS	CHARIOT À BACS POUR PÂTE À PIZZA	WAGEN FÜR PIZZATEIGBEHÄLTER	117	
CESTELLI PER LAVASTOVIGLIE	DISHWASHER BASKETS	PANIERS POUR LAVE-VAISSELLE	KÖRBE FÜR GESCHIRRSPÜLER	118	
CARRELLI E ARTICOLI PER IL SERVIZIO IN CAMERA	CARRELLI PER LA COLAZIONE	BREAKFAST TROLLEYS	CHARIOTS DE PETIT DÉJEUNER	FRÜHSTÜCKSWAGEN	121
	CARRELLI PORTAVALIGIE E PORTABITI	LUGGAGE TROLLEYS AND CLOTHES RACKS	CHARIOTS À BAGAGES ET PORTE-VÊTEMENTS	KOFFERWAGEN UND KLEIDERSTÄNDER	123
TROLLEYS AND EQUIPMENT FOR ROOM SERVICE	CARRELLI PER TRASPORTO PESANTE	TROLLEYS FOR HEAVY TRANSPORT	CHARIOTS POUR CHARGES LOURDES	WAGEN FÜR DEN SCHWERTRANSPORT	127
CHARIOTS ET ARTICLES POUR LE ROOM SERVICE	ASTE DELIMITA CORSIE	RETRACTABLE BARRIERS	DÉLIMITEUR DE ZONE	BEGRENZUNG	128
WAGEN UND AUSRÜSTUNG FÜR DEN ZIMMERSERVICE					

CATEGORIE	IT	EN	FR	DE	
<b>CARRELLI PORTABIANCHERIA, RIFORNIMENTO FRIGOBAR, PULIZIA E MULTIUSO</b> <b>LAUNDRY, MINIBAR, CLEANING AND MULTI-PURPOSE TROLLEYS</b> <b>CHARIOTS À LINGE, RECHARGE MINIBAR, NETTOYAGE ET POLYVALENT</b> <b>WÄSCHEREI-, MINIBAR-, REINIGUNG- UND MEHRZWECKWAGEN</b>	CARRELLI PORTABIANCHERIA	LAUNDRY TROLLEYS	CHARIOTS À LINGE	WÄSCHEWAGEN	<b>131</b>
	CARRELLI PER RIFORNIMENTO FRIGOBAR	TROLLEYS FOR MINI-BAR REFUELLING	CHARIOTS DE REMPLISSAGE POUR MINIBARS	WAGEN FÜR DIE MINIBARFÜLLUNG	<b>133</b>
	CESTONE E CARRELLI CON CESTO PER BIANCHERIA	BASKET AND TROLLEYS WITH LAUNDRY BASKET	PANIERI ET CHARIOTS AVEC PANIER À LINGE	KORB UND WAGEN MIT WÄSCHEKORB	<b>133</b>
	CARRELLI PER PULIZIA	CLEANING TROLLEYS	CHARIOTS DE NETTOYAGE	REINIGUNGSWAGEN	<b>135</b>
<b>ARTICOLI VARI PER LA MACELLERIA</b> <b>ITEMS FOR THE MEAT PROCESSING</b> <b>ARTICLES POUR LA TRANSFORMATION DE LA VIANDE</b> <b>ARTIKEL FÜR DIE FLEISCHVERARBEITUNG</b>	LAVAMANI	HAND WASHER	LAVE-MAINS	HANDWÄSCHER	<b>141</b>
	GREMBIULI E GUANTI	APRONS AND GLOVES	TABLIERS ET GANTS	SCHÜRZEN UND HANDSCHUHE	<b>143</b>
	STERILIZZATORI ELETTRICI PER COLTELLI	ELECTRIC STERILIZERS FOR KNIVES	DISPOSITIFS ÉLECTRIQUES DE DÉSINFECTION POUR COUTEAUX	ELEKTRISCHE ENTKEIMUNGSGERÄTE FÜR MESSER	<b>144</b>
	CEPPI	BUTCHER BLOCKS	BLOCS DE BOUCHERIE	METZGERBLOCKS	<b>146</b>
	TAGLIERI E RASCHIETTO	CUTTING BOARDS AND SCRAPER	PLANCHES À DÉCOUPER ET RACLOIR	SCHNEIDEBRETTER UND ABSTREIFER	<b>148</b>
	ELETTROINSETTICIDI	ELECTRO-INSECTICIDES	ELECTRO-INSECTICIDES	ELEKTROINSEKT-KILLER	<b>149</b>
	SCAFFALATURA MODULARE	MODULAR SHELVING	RAYONNAGE MODULAIRE	MODULAR REGALE	<b>150</b>
<b>ATTREZZATURA PER LA COLAZIONE</b> <b>BREAKFAST EQUIPMENT</b> <b>ÉQUIPEMENT DE PETIT-DÉJEUNER</b> <b>FRÜHSTÜCKSAUSRÜSTUNG</b>	CHAFING DISHES	CHAFING DISHES	CHAFING DISHES	CHAFING DISHES	<b>152</b>
	ZUPPIERA ELETTRICA	ELECTRIC SOUP TUREEN	SOUPIÈRE ÉLECTRIQUE	ELEKTRISCHE SUPPENSCHÜSSEL	<b>158</b>
	DISTRIBUTORI CAFFÈ, BEVANDE E CEREALI	COFFEE, DRINKS AND CEREALS DISPENSERS	DISTRIBUTEURS DE CAFÉ, DE BOISSONS ET DE CÉRÉALES	KAFFEE-, GETRÄNKE- UND MÜSLISPENDER	<b>158</b>
	BOLLITORE E COLTELLO ELETTRICO	KETTLE AND KNIFE ELECTRIC	BOUILLLOIRE ET COUTEAU ÉLECTRIQUE	WASSERKOCHER UND ELEKTRISCHES MESSER	<b>160</b>
	FORNELLO E PADELLA FLAMBÈ	COOKER AND PAN FLAMBÈ	CUISINIÈRE ET CASSEROLE À FLAMBER	HERD UND FLAMMPFANNE	<b>161</b>
<b>ARTICOLI VARI PER CUCINA E PIZZERIA</b> <b>ITEMS FOR COOKING AND PIZZERIA</b> <b>ARTICLES POUR LA CUISINE ET POUR LA PIZZERIA</b> <b>KOCH- UND PIZZERIAARTIKEL</b>	BACINELLE, TEGLIE, VASCHE PER GELATO, VASSOI, APRISCATOLE, MORSO PER PROSCIUTTO, SPATOLE, PALETTE, PINZE, ROTELLE, TAGLIERI, CONTENITORI IMPASTI PER PIZZA, BILANCE	CONTAINERS, PANS, ICE CREAM CONTAINERS, TRAYS, CAN OPENERS, HAM CLAMPS, SPATULAS, SLIDES, CLAMPS, ROLLS, CHOPPING BOARDS, PIZZA DOUGH CONTAINERS, SCALES	BACS, PLAQUES, BACS À CRÈME GLACÉE, PLATEAUX, OUVRE-BOÎTES, OUVRE-BOÎTES, ÉTAU À JAMBON, SPATULES, PALETTES, PINCES, ROUES, PLANCHES À DÉCOUPER, RÉCIPENTS À PÂTE DE PIZZA, BALANCES	BEHÄLTER, BLECHE, EISBEHÄLTER, SCHALEN, DOSENÖFFNER, SCHINKENKLAMMERN, SPATEL, SCHAUFELN, KLAMMERN, ROLLEN, SCHNEIDEBRETTER, PIZZATEIGBEHÄLTER, WAAGEN	<b>162</b>
<b>PATTUMIERE-PORTARIFIUTI</b> <b>GARBAGE AND DUST BINS</b> <b>POUBELLES</b> <b>MÜLL- UND ABFALLBEHÄLTER</b>	PATTUMIERE-PORTARIFIUTI	GARBAGE AND DUST BINS	POUBELLES	MÜLL- UND BFALLBEHÄLTER	<b>181</b>
<b>FORCAR INOX - NEUTRO</b> <b>STEEL FURNITURE</b>	TAVOLI DA LAVORO	WORKING TABLES	-	-	<b>187</b>
	ARMADI IN ACCIAIO INOX CON ANTE SCORREVOLI	SLIDING DOORS STAINLESS STEEL CABINETS	-	-	<b>195</b>
	PENSILI	WALL CUPBOARDS	-	-	<b>196</b>
	MENSOLE IN ACCIAIO INOX	STAINLESS STEEL SHELVES	-	-	<b>199</b>
	LAVELLI	SINKS	-	-	<b>200</b>
	GRUPPI DOCCIA	SHOWER MIXERS	-	-	<b>210</b>
	MISCELATORE MONOFORO	SINGLE HOLE MIXER	-	-	<b>212</b>
	RUBINETTI PER LAVAMANI	TAPS FOR HAND WASHERS	-	-	<b>214</b>

# Indice

INDEX  
TABLE DES MATIÈRES  
INHALTSVERZEICHNIS



CODICE / CODE	
AC5118	128
ACCASGDATS 	189
ACF5190	129
AV4500	171
AV4510	171
AV4515	171
AV4561	161
AV4580	161
AV4581	161
AV4582	169
AV4583	169
AV4620	181
AV4650	181
AV4651	181
AV4652	183
AV4654	183
AV4666	182
AV4667	182
AV4668	182
AV4669	182
AV4671	181
AV4674	185
AV4675	185
AV4676	185
AV4678	185
AV4679	185
AV4680	182



CODICE / CODE	
AV4681	183
AV4682	185
AV4898	141
AV4900	141
AV4901	141
AV4905	173
AV4909	178
AV4910	177
AV4911	175
AV4912	175
AV4913	177
AV4914	177
AV4916	177
AV4918	179
AV4919	175
AV4920	173
AV4921	173
AV4922	172
AV4925	172
AV4926	172
AV4927	172
AV4928	172
AV4929	172
AV4930	172
AV4931	173
AV4932	174
AV4933	174





CODICE / CODE	
AV4934	174
AV4938	178
AV4939	178
AV4941	174
AV4946	175
AV4948	173
AV4949	174
AV4952	178
AV4953	178
AV4954	174
AV4956	178
AV4957	178
AV4959	176
AV4960	172
AV4961	172
AV4965	173
AV4966	173
AV4967	178
AV4970	176
AV4971	176
AV4972	176
AV4973	179
AV4974	179
AV4975	179
B8001	158
BI4719	85
BI4719D	85

CODICE / CODE	
BL4545	170
BM11	80
BM1780	79
BM1782	79
BM1784	79
BM1786	79
BM21	80
BM31	80
BM7700	81
BMP7720	81
BMS1781	79
BMS1785	79
BMS1883	79
BMV11	80
BMV21	80
BMV31	80
BOERO	215
BP4548	170
CA1165	45
CA1380	39
CA1381	39
CA1382	39
CA1383	39
CA1384	39
CA1385	39
CA1386	45
CA1387	45

CODICE / CODE	
CA1388	46
CA1389	46
CA1390	40
CA1390C	46
CA1390S	48
CA1391	40
CA1391C	46
CA1391S	48
CA1391S2	48
CA1392P	44
CA1393P	44
CA1394P	44
CA1395P	44
CA1396	46
CA1399	114
CA1400	114
CA1401	114
CA1410	40
CA1411	40
CA1412	40
CA1413	40
CA1414	41
CA1415	41
CA1416	41
CA1417	41
CA1424	41
CA1425	41
CA1426	41
CA1427	41
CA1430	42
CA1430L60 	42

CODICE / CODE	
CA1431	42
CA1431L60 	42
CA1432	43
CA1432L60 	43
CA1433	43
CA1433L60 	43
CA1435	107
CA1435G	107
CA1436	107
CA1436G	107
CA1437	107
CA1437G	107
CA1438	107
CA1438G	107
CA1439	108
CA1439A	110
CA1439AG	110
CA1439G	108
CA1439P	108
CA1439R	112
CA1439RG	112
CA1440	108
CA1440A	110
CA1440AC	111
CA1440ACG	111
CA1440AG	110
CA1440G	108
CA1450	95
CA1450P	96
CA1451R	97
CA1455	98

CODICE / CODE	
CA1455V12	99
CA1460	95
CA1460P	96
CA1461R	97
CA1465	98
CA1470	95
CA1470P	96
CA1471R	97
CA1475	98
CA1476	100
CA1477	100
CA1478	100
CA1479	100
CA1480	102
CA1480D	102
CA1482	103
CA1482T20	103
CA1483	103
CA1486R	101
CA1489R	101
CA1492R	101
CA1493	103
CA1505 	131
CA1510 	131
CA1515 	131
CA1520	139
CA1525	132
CA1530	132
CA1580	134
CA1584	134
CA1599	134

CODICE / CODE	
CA1599E	134
CA1602	184
CA1603	184
CA1604	136
CA1604E	136
CA1606E	139
CA1613	137
CA1614	137
CA1615	138
CA1616	138
CA1650	102
CA1655	102
CA1656	102
CA3203	133
CA631	113
CA656	113
CA901 	19
CA9012R 	19
CAR2779	69
CAR2780	69
CAR2780BT	69
CB1443	117
CB1444	117
CB1449	117
CB970 	121
CB980 	121
CCL	146
CCP	147
CD6502	156
CD6504	156
CD6505	157

CODICE / CODE		
CD7905		155
CD9801		155
CF1200	● ●	31
CF1201	● ●	31
CF1202	● ●	31
CG1439A		110
CG1439AC		111
CG1439R		112
CL2000	● ●	22
CL2001	● ●	23
CL2150	● ●	22
CL2151	● ●	23
CL2255	● ●	25
CL2260	● ●	25
CL2750	● ●	30
CL2751	● ●	30
CL2752	● ●	30
CL2770N	● ● ○ ● ●	63
CL2774N	● ● ○ ● ●	59
CL2777N	● ● ○ ● ●	57
CL2778N	● ● ○ ● ●	58
CL2785	● ●	25
CL903	● ● ○ ●	19
CLC2012	● ● ○ ●	24
CLC2013	● ● ○ ●	24
CLP2002	● ● ○ ●	20
CLP2002L40	● ●	21
CLP2003	● ● ○ ●	20
CLP2003L40	● ●	21
CLR2786N	● ● ○ ● ●	53
CLR2787N	● ● ○ ● ●	52

CODICE / CODE		
CLR2788N	● ● ○ ● ●	51
CO4099		128
CP1008		49
CP1010		49
CP1441		109
CP1441C		109
CP1442		113
CP1445		116
CP1446		116
CP1447		116
CP1448		116
CPB1472		127
CPB1474		127
CPC600		122
CPE		146
CR1696		133
CST300		122
CT1756		76
CT1758		76
CT1758TD		71
CT1760		76
CT1760C		70
CT1760TD		71
CT1762		76
CT1765		72
CT1765TD		73
CT1766		74
CT1766TD		75
CT1770		72
CT1770TD		73
CT1771		74

CODICE / CODE		
CT1771TD		75
CTS1757		77
CTS1759		77
CTS1761		77
CUP1000		29
CUP800		28
DC10301		160
DC10302		160
DC10502		158
DCN1706		159
DS10401		159
DS10402		159
ELC2828	● ● ○ ● ●	62
ELC2832	● ● ○ ● ●	60
ELC2834	● ● ○ ● ●	61
ELR2825	● ● ○ ● ●	56
ELR2826	● ● ○ ● ●	55
ELR2827	● ● ○ ● ●	54
F15-F17-F20		151
FT30		149
GA5144		128
GD		201
GDASR		190
GDAT		188
GDATS		187
GDCC		194
GDO		211
GDSC		195
GDWB		199
GDWC		197
GNF		166

CODICE / CODE		
GNI		163
GNP		167
GNS		168
GNT		165
GS373		151
G-HR290		105
G-HR540		105
G-VRI211		67
G-VRI311		67
G-VRI311F		67
G-VRI411		67
G-VRI411F		67
HE290		104
HE540		104
HLA		86
HLC		86
HLE		86
HLF		86
HTH125F		93
HTH165F		93
KCP		146
LC50		142
LC50MM		142
LM40		142
LM48		142
LM48M		141
LMM		141
LMMC		141
LP1000	● ● ○ ●	29
LP1050	● ● ○ ●	29
LP800	● ● ○ ●	28

CODICE / CODE		
LP850		28
MIS		212
ML3100SS		33
ML3150ST		33
ML3202SS		34
ML3204SS		35
ML3212SS		34
ML3212SSP		36
ML3214SS		35
ML3214SSP		37
ML5050		32
MS1860RF2		91
MS1862RF2		91
MS1866RF2		91
PC4750		82
PC4752		82
PC4754		82
PC5050		82
PC6040		82
PC8060		82
PCC4710		83
PCI4711		83
PCI4712		83
PCI4713		83
PCI4717		85
PCI4718		85
PCI4718D		85
PEDA		214
PI4714		84
PI4715		84

CODICE / CODE		
PI4716		84
PIA4714		84
PIA4715		84
PIA4716		84
PT15		99
PU5144		128
PU5195		129
PV2001		124
PV2001I		124
PV2002		125
PV2002I		125
PV2003		125
PV2003I		125
PV2021		124
PV2021I		124
PV4056		123
PV4056R		123
PV4064		123
PV4064R		123
PVC4760		82
PVC4763		82
PVC4765		82
PVI4024		126
PZ30N		149
R62-88-97-106-115 124-133-150		151
RASK		148
RTR137L		92
RTR97L		92
RTR97L2		92
RUB30M		213
SP1397		115

CODICE / CODE		
SPB1398		115
ST4060		126
SUV10		145
SUV14		145
SUVN		144
SUVN2P		144
T906		160
TCE20101B		153
TCE20102B		154
TCE20104B		154
TP		148
VBC211		68
VBC311		68
VBC411		68
VBE50		90
VBE85		90
VBN4751		89
VBN4752		89
VBN4753		89
VBN4756		88
VBN4781		89
VBN4782		89
VBN4783		89
VBN4786		88
VBR4751		87
VBR4752		87
VBR4753		87
VBR4756		88
VBR4781		87
VBR4782		87
VBR4783		87

CODICE / CODE		
VBR4786		88
VG		168
VL4748		90
VL4749		90
VPH100		93
VPH120		93
VPH160		93



# Condizioni generali di vendita

## IT

**COSTO DELL' IMBALLO:** compreso nel prezzo per le macchine. Per ricambi ed accessori è previsto un contributo di € 8,00; cassa in legno con coperchio per piastre refrattarie, il contributo è di € 54,00.

**COSTO FISSO GESTIONE ORDINI:** € 10,00 solo per ordini di importo inferiore a € 100,00.

**ORDINI:** gli ordini devono essere trasmessi esclusivamente in forma scritta; nuovi ordini o eventuali modifiche trasmesse in forma orale non verranno accettate.

**CONDIZIONI DI PAGAMENTO:** Si richiede il pagamento con bonifico bancario per: 1. Prime forniture. - 2. Al superamento del fido. - 3. Invio di ricambi.

**DILAZIONI DI PAGAMENTO:** da definire.

Sulle somme pagate in ritardo rispetto alla scadenza pattuita, saranno addebitati gli interessi di mora al tasso legale. Eventuali note di accredito saranno detratte nella fattura successiva.

**PREZZI:** non sono impegnativi, possono subire variazioni senza obbligo di preavviso, in tal caso saranno confermati all'ordine. Tutti i prezzi sono esclusi di IVA.

**TERMINI DI CONSEGNA:** 1. Per l'Italia, possibile spedizione in 24 ore per macchine disponibili a magazzino. 2. Per macchine da produrre considerare circa 25 giorni salvo imprevisti.

**TRASPORTO:** FRANCO FABBRICA, la merce viaggia a rischio e pericolo del committente, per cui Fimar S.p.a. non è responsabile per eventuali danni subiti dalla merce durante il trasporto. Eventuali contestazioni dovranno essere effettuate all'atto della consegna entro i termini di legge.

**ASSISTENZA TECNICA:** a carico del rivenditore per tutta la durata della garanzia di anni uno. Fimar S.p.a. si impegna a fornire, in garanzia, tutti i componenti di ricambio ritenuti difettosi. Il prezzo di vendita fatturato all'utilizzatore finale comprenderà non solo il prezzo dei prodotti finiti venduti, ma anche la gestione da parte del rivenditore della garanzia a copertura di essi. Fimar S.p.a. non dovrà sostenere alcuna spesa diretta o indiretta sostenuta dal rivenditore per la gestione della garanzia. La garanzia decade sul prodotto danneggiato o compromesso da un uso scorretto o comunque non conforme.

**INSTALLAZIONE:** installazione ed istruzione sull'utilizzo delle macchine e dei suoi accessori sono a carico del rivenditore.

**RIPARAZIONI:** nel caso in cui un preventivo di riparazione non venga accettato verranno addebitati € 25,00 quale concorso spese dei costi di gestione.

**GARANZIA:** 12 mesi.

**RESI:** per eventuali resi autorizzati di merce con imballo integro, sarà trattenuta una quota pari al 15% del valore, con un minimo di € 50.

**ASSICURAZIONE:** tutte le nostre macchine sono coperte da assicurazione (responsabilità civile verso terzi) Escluso U.S.A. e CANADA.

**CATALISTINO:** la presente documentazione annulla tutte le precedenti. I dati tecnici, le illustrazioni e le immagini riportate nella presente, sono puramente indicativi. La Ditta si riserva il diritto di modificare le caratteristiche tecniche ed estetiche o sospendere, in ogni momento, la propria produzione senza obbligo di preavviso.

**IMMAGINI ED ILLUSTRAZIONI:** tutte le immagini realizzate dal produttore sono coperte da copyright. L'utilizzo o la riproduzione delle medesime sono soggette ad autorizzazione da parte della Ditta proprietaria del marchio e detentrica dei diritti di proprietà materiale ed intellettuale. I prezzi o i dati tecnici potranno subire variazioni nel caso di errori tipografici o di cambiamenti in corso d'opera.

**MARCHI E BREVETTI:** è fatto espresso divieto di utilizzare i marchi e/o i brevetti registrati dalla Fimar S.p.a. Si precisa che tutti i macchinari e gli accessori non marcati CE presentano caratteristiche specifiche che non li rendono idonei alla vendita all'interno dei paesi dell'Unione Europea.

**RICHIESTA DI DOCUMENTAZIONE TECNICA AGGIUNTIVA:** Copia conforme all'originale della Certificazione CE: € 20,00 + spese di spedizione - Copia cartacea del Manuale d'Uso e Manutenzione: € 40,00 + spese di spedizione.

MOD177V01 - FINITO DI STAMPARE NEL SETTEMBRE 2025

## EN

**PACKAGING COSTS:** included in the price for equipment. Spare parts and accessories are subject to a surcharge of €8.00. Wooden crate with lid for refractory plates is subject to a surcharge of €54.00.

**FIXED COST OF ORDER MANAGEMENT:** € 10.00 only on orders of less than € 100.00.

**ORDERS:** Orders must be transmitted in written form only; new orders or any changes transmitted in verbal form will not be accepted.

**PAYMENT TERMS:** Payment by bank transfer is required for: 1. First deliveries. - 2. On exceeding the credit limit. - 3. Shipment of spare parts.

**PAYMENT DEFERRALS:** To be defined.

Interest at the legal rate shall be charged on sums paid late with respect to the agreed due date. Any credit notes will be deducted from the next invoice.

**PRICES:** these are not binding, they may vary without prior notice, in which case they will be confirmed on the order. Prices are VAT excluded.

**DELIVERY TERMS:** 1. For Italy, possible shipment within 24 hours for machines in stock. 2. For machines to be produced, please allow approximately 25 days, barring unforeseen circumstances.

**SHIPMENT:** EX WORKS, goods travel at the customer's risk, therefore Fimar S.p.a. is not responsible for any damage suffered by the goods during transport. Any claims must be made at the time of delivery within the legal terms.

**TECHNICAL ASSISTANCE:** charged to the dealer for the entire duration of the warranty of one year. Fimar S.p.a. undertakes to supply, under warranty, all spare parts deemed defective. The sales price invoiced to the end user shall include not only the price of the finished products sold, but also the dealer's handling of the warranty covering them. Fimar S.p.a. shall not incur any direct or indirect expenses borne by the retailer for the management of the warranty. The warranty shall be void if the product is damaged or impaired by incorrect or otherwise non-compliant use.

**INSTALLATION:** installation and instruction in the use of the machine and its accessories are the responsibility of the dealer.

**REPAIRS:** in the event that a repair quote is not accepted, € 25.00 will be charged as a contribution towards operating costs.

**WARRANTY:** 12 months.

**RETURNS:** for any authorised returns of goods with undamaged packaging, a fee of 15% of the value will be withheld, with a minimum of € 50.

**INSURANCE:** all our machines are covered by insurance (third party liability) Excluding U.S.A. and CANADA.

**CATALOGUE:** this document invalidates all previous ones. The technical data, illustrations and pictures in this document are purely indicative. The Company reserves the right to modify the technical and aesthetic characteristics or discontinue its production at any time without prior notice.

**IMAGES AND ILLUSTRATIONS:** All images taken by the manufacturer are covered by copyright. Their use or reproduction is subject to authorisation by the company that owns the trademark and holds the material and intellectual property rights. Prices or technical data may be subject to change in the event of typographical errors or changes.

**TRADEMARK AND PATENTS:** It is expressly forbidden to use the trademarks and/or patents registered by Fimar S.p.a.. Please note that all machinery and accessories that are not CE marked have specific characteristics that make them unsuitable for sale within the countries of the European Union.

**REQUEST FOR ADDITIONAL TECHNICAL DOCUMENTATION:** Copy conforming to the original of the CE Certification: € 20.00 + shipping costs - Hard copy of the Use and Maintenance Manual: € 40.00 + shipping costs.

MOD177V01 - PRINTED IN SEPTEMBER 2025

FR

**FRAIS D'EMBALLAGE:** inclus dans le prix des machines. Pour les pièces détachées et les accessoires, il faut compter une contribution de 8,00 €; pour la caisse en bois pour les plaques réfractaires avec couvercle, la contribution est de 54,00 €.

**FRAIS FIXES DE GESTION DES COMMANDES:** 10,00 € uniquement pour les commandes inférieures à 100,00 €.

**COMMANDES:** Les commandes doivent être transmises uniquement par écrit; les nouvelles commandes ou les modifications transmises oralement ne seront pas acceptées.

**CONDITIONS DE PAIEMENT:** Le paiement par virement bancaire est exigé pour: 1. les premières livraisons - 2. en cas de dépassement de la limite de crédit - 3. L'envoi de pièces détachées.

**RETARDS DE PAIEMENT:** à définir.

Les sommes payées en retard par rapport à la date d'échéance convenue sont majorées d'un intérêt au taux légal. Les avoirs éventuels seront déduits de la facture suivante.

**PRIX:** ils ne sont pas contractuels, ils peuvent varier sans préavis, auquel cas ils seront confirmés lors de la commande. Tous les prix s'entendent hors TVA.

**CONDITIONS DE LIVRAISON:** 1) Pour l'Italie, expédition possible dans les 24 heures pour les machines en stock. 2) Pour les machines à produire, il faut compter environ 25 jours, sauf imprévus.

**TRANSPORT:** EX WORKS, la marchandise voyage aux risques et périls du client, par conséquent Fimar S.p.a. n'est pas responsable des éventuels dommages subis par la marchandise pendant le transport. Toute réclamation doit être faite au moment de la livraison dans les délais légaux.

**ASSISTANCE TECHNIQUE:** à la charge du revendeur pendant toute la durée de la garantie d'un an. Fimar S.p.a. s'engage à fournir, sous garantie, toutes les pièces de rechange jugées défectueuses. Le prix de vente facturé à l'utilisateur final comprend non seulement le prix des produits finis vendus, mais aussi la prise en charge par le revendeur de la garantie qui les couvre. Fimar S.p.a. ne supportera pas les frais directs ou indirects encourus par le revendeur pour la gestion de la garantie. La garantie est annulée si le produit est endommagé ou détérioré à la suite d'une utilisation incorrecte ou non conforme.

**INSTALLATION:** l'installation et la formation à l'utilisation de l'appareil et de ses accessoires sont à la charge du revendeur.

**RÉPARATIONS:** en cas de refus d'un devis de réparation, 25,00 € seront facturés à titre de participation aux frais d'exploitation.

**GARANTIE:** 12 mois.

**RETOURS:** pour tout retour autorisé de marchandises dans un emballage intact, une retenue de 15% de la valeur sera effectuée, avec un minimum de 50 €.

**ASSURANCE:** toutes nos machines sont couvertes par une assurance (responsabilité civile), à l'exclusion des États-Unis et du Canada.

**CATALOGUE LISTE:** Ce document annule tous les documents précédents. Les données techniques, les illustrations et les photos contenues dans ce document sont purement indicatives. La société se réserve le droit de modifier les caractéristiques techniques et esthétiques ou d'arrêter la production à tout moment et sans préavis.

**IMAGES ET ILLUSTRATIONS:** Toutes les images prises par le fabricant sont couvertes par le droit d'auteur. Leur utilisation ou leur reproduction est soumise à l'autorisation de la société propriétaire de la marque et détentrice des droits matériels et de propriété intellectuelle. Les prix ou les données techniques peuvent être modifiés en cas d'erreurs typographiques ou de changements.

**MARQUES ET BREVETS:** Il est expressément interdit d'utiliser les marques et/ou les brevets déposés par Fimar S.p.a.. Il est à noter que les machines et les accessoires non marqués CE présentent des caractéristiques spécifiques qui les rendent impropres à la vente dans les pays de l'Union européenne.

**DEMANDE DE DOCUMENTATION TECHNIQUE SUPPLÉMENTAIRE:** Copie conforme à l'original de la certification CE: 20,00 € + frais d'expédition - Copie papier du manuel d'utilisation et d'entretien: 40,00 € + frais d'expédition.

MOD177V01 - IMPRESSION TERMINÉE EN SEPTEMBRE 2025

DE

**VERPACKUNGSKOSTEN:** im Gerätepreis enthalten. Für Ersatzteile und Zubehör werden 8,00 € als Beitrag erhoben; für die Holzkiste für feuerfeste Platten mit Deckel beträgt der Beitrag 54,00 €.

**FESTE KOSTEN FÜR DIE BESTELLUNGSVERWALTUNG:** 10,00 € nur für Bestellungen unter 100,00 €.

**AUFTRÄGE:** Aufträge sind ausschließlich in schriftlicher Form zu übermitteln; mündlich übermittelte Neuaufträge oder Änderungen werden nicht angenommen.

**ZAHLUNGSBEDINGUNGEN:** Die Zahlung per Banküberweisung ist erforderlich: 1. bei der ersten Lieferung - 2. bei Überschreitung des Kreditlimits. - 3. bei Versand von Ersatzteilen.

**ZAHLUNGSVERZÖGERUNGEN:** zu bestimmen.

Auf verspätet gezahlte Beträge werden Verzugszinsen in Höhe des gesetzlichen Zinssatzes erhoben. Eventuelle Gutschriften werden mit der nächsten Rechnung verrechnet.

**PREISE:** Sie sind unverbindlich und können ohne vorherige Ankündigung geändert werden; in diesem Fall werden sie auf der Bestellung bestätigt. Alle Preise verstehen sich ohne Mehrwertsteuer.

**LIEFERBEDINGUNGEN:** 1. für Italien, möglicher Versand innerhalb von 24 Stunden für Geräte auf Lager. 2) Für Geräte, die hergestellt werden sollen, beträgt die Lieferzeit etwa 25 Tage, sofern keine unvorhergesehenen Umstände eintreten.

**TRANSPORT:** AB WERK, die Ware reist auf Risiko des Kunden, daher ist Fimar S.p.a. nicht für eventuelle Schäden an der Ware während des Transports verantwortlich. Eventuelle Reklamationen müssen zum Zeitpunkt der Lieferung innerhalb der gesetzlichen Fristen geltend gemacht werden.

**TECHNISCHE UNTERSTÜTZUNG:** zu Lasten des Händlers für die gesamte Dauer der Garantie von einem Jahr. Fimar S.p.a. verpflichtet sich, im Rahmen der Garantie alle Ersatzteile zu liefern, die als defekt gelten. Der dem Endverbraucher in Rechnung gestellte Verkaufspreis umfasst nicht nur den Preis für die verkauften Endprodukte, sondern auch die Abwicklung der Garantie durch den Händler. Fimar S.p.a. übernimmt keine direkten oder indirekten Kosten, die dem Wiederverkäufer durch die Abwicklung der Garantie entstehen. Die Garantie erlischt, wenn das Produkt durch unsachgemäßen oder anderweitig nicht konformen Gebrauch beschädigt oder beeinträchtigt wird.

**INBETRIEBNAHME:** Die Inbetriebnahme und die Einweisung in den Gebrauch des Geräts und seines Zubehörs liegen in der Verantwortung des Händlers.

**REPARATUREN:** Falls ein Kostenvoranschlag für eine Reparatur nicht akzeptiert wird, werden 25,00 € als Beitrag zu den Betriebskosten berechnet.

**GARANTIE:** 12 Monate.

**RÜCKGABE:** Für jede genehmigte Rücksendung von Waren mit unbeschädigter Verpackung wird eine Gebühr von 15 % des Wertes einbehalten, mindestens jedoch 50 €.

**VERSICHERUNG:** Alle unsere Geräte sind versichert (Haftpflicht), ausgenommen USA und KANADA.

**KATALOG-PREISLISTE:** Dieses Dokument ersetzt alle vorherigen Dokumente. Die technischen Daten, Illustrationen und Bilder in diesem Dokument sind rein indikativ. Das Unternehmen behält sich das Recht vor, die technischen und ästhetischen Merkmale zu ändern oder die Produktion jederzeit und ohne Vorankündigung einzustellen.

**BILDER UND ILLUSTRATIONEN:** Alle vom Hersteller aufgenommenen Bilder sind urheberrechtlich geschützt. Ihre Verwendung oder Vervielfältigung unterliegt der Genehmigung des Unternehmens, das Eigentümer der Marke und Inhaber der materiellen und geistigen Eigentumsrechte ist. Preise oder technische Daten können im Falle von Druckfehlern oder Änderungen geändert werden.

**MARKEN UND PATENTE:** Es ist ausdrücklich verboten, die von Fimar S.p.a. eingetragenen Marken und/oder Patente zu verwenden. Wir weisen darauf hin, dass alle Maschinen und Zubehörteile, die nicht mit der CE-Kennzeichnung versehen sind, besondere Merkmale aufweisen, die sie für den Verkauf in den Ländern der Europäischen Union ungeeignet machen.

**ANFORDERUNG VON ZUSÄTZLICHEN TECHNISCHEM DOKUMENTEN:** Kopie, die dem Original der CE-Zertifizierung entspricht: € 20,00 + Versandkosten - Ausdruck der Bedienungs- und Wartungsanleitung: 40,00 € + Versandkosten.

MOD177V01 - DRUCKFERTIGSTELLUNG IM SEPTEMBER 2025



# Carrelli e mobili di servizio in legno

WOOD TROLLEYS  
AND SERVICE FURNITURE  
CHARIOTS ET MEUBLES  
DE SERVICE EN BOIS  
WAGEN UND SERVICEMÖBEL AUS HOLZ

## CA901 - CA9012R



CA901CA



CA9012R



## CL903



CL903B



**IT** Carrelli Guéridon. Struttura portante in tubo di acciaio inox AISI 304 - ripiani in nobilitato con bordo in gomma - ruote multidirezionali ø 95 mm (2 ruote mod. CA9012R - 4 ruote mod. CA901).

**EN** Guéridon trolleys. Tubular stainless steel AISI 304 supporting structure - melamine shelves with rubber edges - multidirectional wheels ø 95 mm (2 wheels mod. CA9012R - 4 wheels mod. CA901).

**FR** Chariots Guéridon. Structure portante en tube d'acier inox AISI 304 - étagères en mélaminé avec bord en caoutchouc - roues multidirectionnelles ø 95 mm (2 roues mod. CA9012R - 4 roues mod. CA901).





**DE** Guéridon Wagen. Stützrahmen aus Edelstahlrohr AISI 304 - Melaminböden mit Gummikante - 2 multidirektionale Räder ø 95 mm (2 Räder Mod. CA9012R - 4 Räder Mod. CA901).





**IT** Carrelli Guéridon. Struttura portante in legno massello - ripiani in nobilitato con bordo in gomma (escluso CL903B - CL903N) - ruote multidirezionali ø 95 mm.

**EN** Guéridon trolleys. Solid wood supporting structure - melamine shelves with rubber edges (not for CL903B - CL903N) - multidirectional wheels ø 95 mm.

**FR** Chariots Guéridon. Structure portante en bois massif - étagères en mélaminé avec bord en caoutchouc (à l'exclusion du code CL903B CL903N) - roues multidirectionnelles ø 95 mm.

**DE** Guéridon Wagen. Stützrahmen aus Massivholz- Einlegeböden aus Melamin mit Gummikante (ohne den Code CL903B - CL903N) - Mehrwegräder ø 95 mm.

	CA901 noce-walnut	CA901CA carbon	CA9012R noce-walnut	CA9012RCA carbon
	70 x 50 x 78(h) cm			
	2			
	40 Kg			
	375 €		355 €	

	CL903 noce-walnut	CL903CA carbon	CL903B laccato bianco laquered white	CL903N laccato nero laquered black
	70 x 50 x 78(h) cm			
	2			
	40 Kg			
	375 €		710 €	

Carrelli Guéridon  
Guéridon trolleys

OPTIONAL



## CLP2002



CLP2002N

IT Carrelli di servizio in legno. Struttura in legno massello - ripiani in multistrato di betulla - maniglie di spinta integrate nel piano superiore - ringhiere di contenimento sui piani inferiori - ruote multidirezionali ø 95 mm.

EN Wooden service trolleys. Solid wood structure - birch multi-layered wood shelves - integrated push handles in the upper shelf - retaining rails on the lower shelves - multidirectional wheels ø 95 mm.

## CLP2003



CLP2003B

FR Chariots de service en bois. Structure en bois massif - étagères en bouleau multicouche - poignées de poussée intégrées à l'étagère supérieur - profilés de retenue aux étagères inférieures - roues multidirectionnelles ø 95 mm.

DE Servicewagen aus Holz. Massivholzstruktur - Ablageflächen aus Birkensperholz - Schubgriffe eingebaut an der obersten Fläche - Mehrwegräder ø 95 mm.



NOCE/WALNUT



CARBON

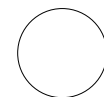

LACCATO BIANCO  
LAQUERED WHITE



LACCATO NERO  
LAQUERED BLACK

	CLP2002 noce-walnut	CLP2002CA carbon	CLP2002B laccato bianco laquered white	CLP2002N laccato nero laquered black	CLP2003 noce-walnut	CLP2003CA carbon	CLP2003B laccato bianco laquered white	CLP2003N laccato nero laquered black
	110 x 55 x 82(h) cm				110 x 55 x 89(h) cm			
	2				3			
	80 Kg				80 Kg			
	750 €		940 €		990 €		1.270 €	

# CLP2002L40



CLP2002L40CA

**IT** Carrelli di servizio in legno. Struttura in legno massello - ripiani in multistrato di betulla - maniglie di spinta integrate nel piano superiore - ruote multidirezionali ø 95 mm.

**EN** Wooden service trolleys. Solid wood structure - birch multi-layered wood shelves - integrated push handles in the upper shelf - multidirectional wheels ø 95 mm.

# CLP2003L40







CLP2003L40CA

**FR** Chariots de service en bois. Structure en bois massif - étagères en bouleau multicouche - poignées de poussée intégrées à l'étagère supérieur - roues multidirectionnelles ø 95 mm.

**DE** Servicewagen aus Holz. Massivholzstruktur - Ablageflächen aus Birkensperrholz - Schubgriffe eingebaut an der obersten Fläche - Mehrwegräder ø 95 mm.



	CLP2002L40 noce-walnut	CLP2002L40CA carbon	CLP2003L40 noce-walnut	CLP2003L40CA carbon
				
	110 x 40 x 82(h) cm		110 x 40 x 89(h) cm	
	2		3	
	80 Kg		80 Kg	
	655 €		835 €	

OPTIONAL



# CL2000



CL2000

IT Carrelli di servizio in legno. Struttura in legno multistrato di betulla  
- ripiani in nobilitato - cornice perimetrale e maniglia in legno massello  
- ruote multidirezionali di serie cromate ø 100 mm.

# CL2150



CL2150

EN Wooden service trolleys. Birch plywood frame - veneered shelves  
- solid wood perimeter frame and handle - standard chromed multi-directional wheels ø 100 mm.



A1299

	CL2000 noce-walnut	CL2000CA carbon	CL2150 noce-walnut	CL2150CA carbon	A1299 noce-walnut	A1299CA carbon
	86 x 55 x 85(h) cm				Vetrinetta con struttura in legno e cupola in plexiglass Display with wooden structure and Plexiglas dome	
	2		3		CL2000 CL2150	CL2000CA CL2150CA
	80 Kg				70 x 50 x 22(h) cm	
	840 €		970 €		400 €	

# CL2001



CL2001CA

# CL2151



CL2151CA



NOCE/WALNUT



CARBON

FR Chariots de service en bois - cadre en contreplaqué de bouleau  
- étagères plaquées - cadre périmétrique et poignée en bois massif  
- roues chromées multidirectionnelles standard ø 100 mm.





DE Servierwagen aus Holz - Struktur aus Birkensperrholz - furnierte Böden - Struktur und Griff aus Massivholz - verchromte Standard-Räder ø 100 mm.



A1298



A1290

	CL2001 noce-walnut	CL2001CA carbon	CL2151 noce-walnut	CL2151CA carbon	A1298 noce-walnut	A1298CA carbon	A1290 noce-walnut	A1290CA carbon
								
	106 x 55 x 85(h) cm				Vetrinetta con struttura in legno e cupola in plexiglass Display with wooden structure and Plexiglas dome		Espositore ghiacciaia provvisto di 8 contenitori eutectici Icebox display with 8 eutectic containers	
	2		3		CL2001 CL2151	CL2001CA CL2151CA	CL2001 CL2151	CL2001CA CL2151CA
	80 Kg				90 x 50 x 22(h) cm		90 x 48,5 x 23(h) cm	
	885 €		1.025 €		430 €		930 €	

OPTIONAL



## CLC2012



CLC2012

IT Carrelli di servizio in legno con cupola. Struttura in legno massello - ripiani in multistrato di betulla - cupola semicircolare in plexiglass apribile su due lati - maniglie di spinta integrate nel piano superiore - ringhiere di contenimento sui piani inferiori - ruote multidirezionali ø 95 mm.

EN Wooden service trolleys with dome. Solid wood structure - birch multi-layered wood shelves - half-circle dome in Plexiglas that opens on two sides - integrated push handles in the upper shelf - retaining rails on the lower shelves - multidirectional wheels ø 95 mm.

## CLC2013



CLC2013CA

FR Chariots de service en bois avec clochette. Structure en bois massif - étagères en bouleau multicouche - clochette en plexiglas de forme semi-circulaire avec ouverture sur les deux côtés - poignées de poussée intégrées à l'étagère supérieure - profilés de retenue aux étagères inférieures - roues multidirectionnelles ø 95 mm.

DE Servicewagen aus Holz für Kuchen. Massivholzstruktur - Ablageflächen aus Birkensperrholz - zweiseitig aufklappbare, halbrunde Plexiglashaube - Schubgriffe eingebaut an der obersten Fläche - Halterungen in den untersten Etagen - Mehrwegräder ø 95 mm.

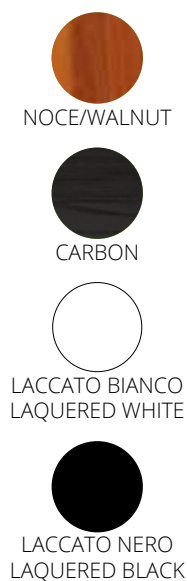

	CLC2012 noce-walnut	CLC2012CA carbon	CLC2012B laccato bianco laquered white	CLC2012N laccato nero laquered black	CLC2013 noce-walnut	CLC2013CA carbon	CLC2013B laccato bianco laquered white	CLC2013N laccato nero laquered black
	110 x 55 x 107(h) cm				110 x 55 x 114(h) cm			
	2				3			
	80 Kg				80 Kg			
	1.080 €		1.260 €		1.300 €		1.575 €	

## CL2255 - CL2260



CL2255CA

**IT** Carrelli di servizio in legno con cupola. Struttura portante in legno multistrato di betulla - cupola semicircolare in plexiglass apribile su due lati - maniglia di spinta in legno - 2 ripiani - ruote multidirezionali ø 100 mm.

**EN** Wooden service trolleys with dome. Load-bearing structure in birch multi-layered wood - half-circle dome in Plexiglas that opens on two sides - wooden push handle - 2 shelves - multidirectional wheels ø 100 mm.

**FR** Chariots de service en bois avec clochette. Structure portante en bouleau multicouche - clochette en plexiglas de forme semi-circulaire avec ouverture sur les deux côtés - poignée en bois - 2 étagères- roues multidirectionnelles ø 100 mm.

**DE** Servicewagen aus Holz für Kuchen. Struktur aus Birkensperholz Birkenholz - zweiseitig aufklappbare, halbrunde Plexiglashaube - Schubgriff aus Holz - 2 Einlegeböden - Mehrwegräder ø 100 mm.

	CL2255 noce-walnut	CL2255CA carbon	CL2260 noce-walnut	CL2260CA carbon
	86 x 55 x 110(h) cm		106 x 55 x 110(h) cm	
	2			
	80 Kg			
	1.090 €		1.150 €	

## CL2785



CL2785



8 PIASTRE EUTETTICHE  
REFRIGERANTI  
8 REFRIGERANT EUTECTIC  
PLATES

**IT** Carrello di servizio in legno con cupola. Struttura portante in legno multistrato di betulla - cupola in plexiglass trasparente 150(h) mm - vasca e griglia in acciaio inox - 8 piastre eutettiche refrigeranti - ruote multidirezionali ø 100 mm.

**EN** Wooden service trolley with dome. Multi-layered birch wood supporting structure - clear Plexiglas dome 150(h) mm - stainless steel bowl and grid - 8 refrigerant eutectic plates - multidirectional wheels ø 100 mm.

**FR** Chariot de service en bois avec clochette. Structure portante en bouleau multicouche - clochette en plexiglas transparent 150(h) mm - cuve et grille en acier inox - 8 plaques de refroidissement eutectiques - roues multidirectionnelles ø 100 mm.

**DE** Servicewagen aus Holz für Kuchen. Tragkonstruktion aus Birkensperholz - transparente Plexiglashaube 150(h) mm - Edelstahlbehälter und Grill - 8 Eutektik-Kühlplatten - Mehrwegräder ø 100 mm.

	CL2785 noce-walnut	CL2785CA carbon
	106 x 55 x 108(h) cm	
	2	
	820 x 410 x 60(h) mm - 5x GN1/4 (40h mm) o/or 5x GN1/6 (40h mm) non include / not included	
	50 Kg	
	2.020 €	

OPTIONAL



# OPTIONAL



A100  
CLP-CL-CLC

Pianetto reggi piatto a scomparsa  
Retractable shelf  
Étagère à plateaux encastrée  
Verdeckte Tablettablage

85 €

A200  
CLP-CL-CLC

Cassetto portaposate a 3 scomparti  
Cutlery drawer with 3 compartments  
Tiroir à couverts avec 3 compartiments  
Besteckschublade mit 3 Fächern

125 €

# OPTIONAL



CL903RCO

A800

A800  
CA-CLP-CL-CLC

A850  
CA-CLP-CL-CLC

4 ruote con cuffia ottonata o cromata - 4 brass or chrome plated copper castors  
4 roulette à bille en laiton ou chromée - 4 Messing- oder Chrom-Kugelrolle



160 €



160 €

# LP800 - LP850



LP800CE



OPTIONAL A850

LP850BRC

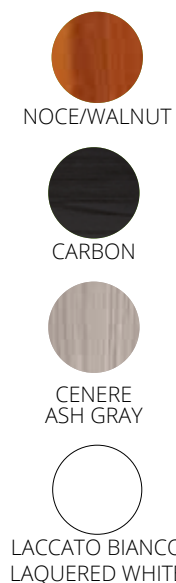

**IT** Carrelli di servizio in legno. Struttura in legno massello - ripiani in nobilitato di betulla - reggi piatto incluso - ruote multidirezionali cromate Ø 100 mm. Telaio e cupola in plexiglass trasparente acquistabile come optional e facilmente applicabile (CUP800-CUP1000).

**EN** Wooden service trolleys. Solid wood frame - birch veneer shelves - plate holders included - chromed multidirectional wheels Ø 100 mm. Clear Plexiglass frame and dome can be purchased as an option and easily installed (CUP800-CUP1000).

OPTIONAL



CUP800 - CUP1000

CUP800
LP800 - LP850 Cupola / Dome clear plexiglass
70 x 50 x 22(h) cm
<b>430 €</b>

	LP800 noce-walnut	LP800CA carbon	LP800CE cenere-ash gray	LP800B laccato bianco laquered white	LP850 noce-walnut	LP850CA carbon	LP850CE cenere-ash gray	LP850B laccato bianco laquered white
	81 x 55 x 82(h) cm							
	2				3			
	80 Kg				80 Kg			
	990 €		1.150 €		1.210 €		1.370 €	

# LP1000 - LP1050



LP1000B



OPTIONAL A850

LP1050CARC

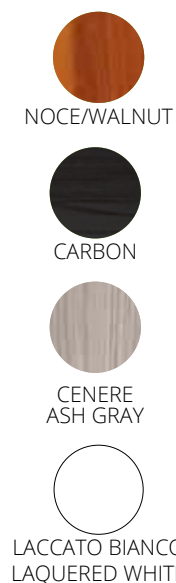

FR Chariots de service en bois. Structure en bois massif - étagères en placage de bouleau - porte-assiettes inclus - roues multidirectionnelles chromées ø 100 mm. Cadre et clochette en plexiglass transparent peuvent être achetés en option et facilement installés (CUP800-CUP1000).

DE Servicewagen aus Holz. Struktur aus Massivholz - Einlegeböden aus Birkenfurnier - inkl. Tellerhalter - verchromte Mehrwegrädern ø 100 mm. Rahmen und Haube aus durchsichtigem Plexiglass können als Option erworben und leicht angebracht werden (CUP800-CUP1000).

OPTIONAL



A800

A850

A800	A850
4 ruote con cuffia ottonata o cromata 4 brass or chrome plated capper castors 4 roulette à bille en laiton ou chromée 4 Messing- oder Chrom-Kugelrolle	
160 €	

CUP1000
LP1000 - LP1050 Cupola / Dome clear plexiglass
90 x 50 x 22(h) cm
480 €

	LP1000 noce-walnut	LP1000CA carbon	LP1000CE cenere-ash gray	LP1000B laccato bianco laquered white	LP1050 noce-walnut	LP1050CA carbon	LP1050CE cenere-ash gray	LP1050B laccato bianco laquered white
	115 x 55 x 82(h) cm							
	2				3			
	80 Kg				80 Kg			
	1.080 €		1.205 €		1.320 €		1.440 €	

# CL2750 - CL2751 - CL2752



NOCE/WALNUT



CARBON



CL2751



CL2752CA

**IT** Carrelli Flambé. Struttura portante in legno multistrato di betulla - rivestimento in legno massello di castagno - piano di cottura in acciaio inox con bruciatore regolabile - ribaltina laterale - portabottiglie e maniglia in acciaio inox - 2 cassetti - vano porta bombola da 2 kg - 2 ruote con freno  $\varnothing$  100 mm.

**EN** Flambé trolleys. Load-bearing structure in one-piece multi-layered wood - solid chestnut wood lining - stainless steel push handle - stainless steel cooking plate with adjustable burner - side folding panel - stainless steel bottle rack - 2 drawers - 2 kg gas bottle compartment - 2 wheels with catch  $\varnothing$  100 mm.

**FR** Chariots Flambé. Structure portante en bois de bouleau multicouche à structure monocoque - revêtement en châtaignier massif - plaque de cuisson en acier inox avec brûleur réglable - poignée de pous-sée en acier inox - porte-bouteille en acier inox - 2 tiroirs - compartiment porte- bouteille de 2 kg - 2 roues avec frein  $\varnothing$  100 mm.

**DE** Flambé-Wagen. Monoblock Struktur aus Birkenperrholz - Verkleidung aus massivem Kastanienholz - Kochplatte aus Edelstahl mit einstellbarem Brenner - Seitenklappe - Schubgriff aus Edelsstahl - Flaschenständeraus Edelstahl - 2 Schubladen - 2 kg Gasflaschenfach - 2 räder mit Bremse  $\varnothing$  100 mm.

A800	A850
4 ruote con cuffia ottonata o cromata - 4 brass or chrome plated capper castors 4 roulette à bille en laiton ou chromée - 4 Messing- oder Chrom-Kugelrolle	
160 €	



CL2750

	CL2750 noce-walnut	CL2750CA carbon	CL2751 noce-walnut	CL2751CA carbon	CL2752 noce-walnut	CL2752CA carbon	AB2 CL2750-2751-2752
	107/145 x 58 x 91(h) cm						Bombola gas 2 kg (vuota) Gas bottle 2 kg (empty)
	1 piastra - 2 fuochi 1 plate - 2 burners		1 piastra - 1 fuoco 1 plate - 1 burner		2 piastre a 1 fuoco separato 2 plates 1 separate burner		
	35 Kg						
	2.110 €		1.970 €		2.350 €		90 €

# CF1200 - CF1201 - CF1202



NOCE/WALNUT



CARBON



CF1201



CF1200

**IT** Carrelli Flambè. Struttura portante in legno nobilitato - piano di cottura in acciaio inox con bruciatore regolabile - ribaltina laterale - portabottiglie e maniglia in acciaio inox - 1 cassetto - 1 sportello vano porta bombola da 3 Kg - 2 ruote con freno  $\varnothing$  100 mm.

**EN** Flambè trolleys. Load-bearing structure in laminated wood - stainless steel cooking plate with adjustable burner - side folding panel - stainless steel push handle - stainless steel bottle rack - 1 drawer - 3 kg gas bottle compartment - 2 wheels with catch  $\varnothing$  100 mm.

**FR** Chariots Flambé. Structure portante en bois mélaminé - plaque de cuisson en acier inox avec brûleur réglable - volet latéral - poignée de poussée en acier inox - porte-bouteille en acier inox - 1 tiroir - compartiment avec porte pour bouteille de 3 kg - 2 roues avec frein  $\varnothing$  100 mm.

**DE** Flambè-Wagen. Struktur aus melaminharzbeschichtetem Holz - Kochplatte aus Edelstahl mit einstellbarem Brenner - Schubgriff aus Edelstahl - Flaschenständeraus Edelstahl - 1 Schublade - 3 Kg Gasflaschenfach - 2 räder mit Bremse  $\varnothing$  100 mm.



CF1202CA

	CF1200 noce-walnut	CF1200CA carbon	CF1201 noce-walnut	CF1201CA carbon	CF1202 noce-walnut	CF1202CA carbon	AB3 CF1200-1201-1202
	105/137 x 57 x 91(h) cm						Bombola gas 3 kg (vuota) Gas bottle 3 kg (empty)
	1 piastra - 1 fuoco 1 plate - 1 burner		1 piastra - 2 fuochi 1 plate - 2 burners		2 piastre a 1 fuoco separato 2 plates 1 separate burner		
	35 Kg						
	1.460 €		1.600 €		1.850 €		95 €

# ML5050



ML5050CA

OPTIONAL  
A5050CE



ML5050CE

OPTIONAL  
A5050CE



ML5050CE

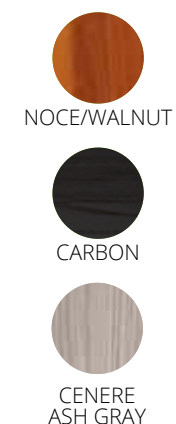



IT Mobile di servizio alto singolo - struttura e pannelli in nobilitato - 1 cassetto portaposate con separatore - 1 cassetto libero - 1 sportello con ripiano intermedio. Possibilità di mensola montabile a sinistra o destra come optional.

EN High single service cabinet - structure and panels in melamine - 1 cutlery drawer with separator - 1 free drawer - 1 door with intermediate shelf. Optional left or right hand fitted shelf.

FR Meuble de service haut simple - structure et panneaux en mélamine - 1 tiroir à couverts avec séparateur - 1 tiroir libre - 1 porte avec étagère intermédiaire. Etagère à monter à gauche ou à droite en option.

DE Einzelner hoher Servicemöbel - Struktur und Blenden aus Melamin - 1 Besteckschublade mit Trennwand - 1 freie Schublade - 1 Tür mit Zwischenregal. Einlegeboden wahlweise links oder rechts einsetzbar.

	ML5050N noce-walnut	ML5050CA carbon	ML5050CE cenere-ash gray
	45 x 49 x 144(h) cm		
	1 sportello - 2 cassetti 1 door - 2 drawers		
	820 €		

A5050N noce-walnut	A5050CA carbon	A5050CE cenere-ash gray
Mensola per mobile di servizio Shelf for service cabinet		
50 x 25 cm		
50 €		

# ML3100SS



ML3100SS

**IT** Mobili di servizio alti doppi - struttura e pannelli in nobilitato con bordi protetti da profilo in gomma - alzatina con 2 mensole - 2 cassetti portaposate di cui 1 con separatore - 2 sportelli (SS) oppure 1 sportello con ripiano intermedio e 1 tramoggia (ST) - ruote multidirezionali  $\varnothing$  50 mm.

**EN** High double service cabinets - structure and panels in melamine with edges protected by rubber profile - backsplash with 2 shelves - 2 cutlery drawers, 1 with separator - 2 doors (SS) or 1 door with intermediate shelf and 1 hopper (ST) - multidirectional wheels  $\varnothing$  50 mm.

**FR** Meubles hauts de service double - structure et panneaux en mélaminé avec bords en caoutchouc - dossier avec 2 étagères - 2 tiroirs à couverts dont 1 avec séparateur - 2 portes (SS) ou 1 porte avec étagère intermédiaire et 1 trémie (ST) - roues multidirectionnelles  $\varnothing$  50 mm.

**DE** Hohe Doppelservicemöbel - Struktur und Blenden aus Melamin mit Gummikantenschutz - Rückwand mit 2 Regalen - 2 Besteckschubladen, davon 1 mit Trennwand - 2 Türen (SS) oder 1 Tür mit Zwischenregal und 1 Trichter (ST) - Mehrwegräder  $\varnothing$  50 mm.

# ML3150ST



NOCE/WALNUT



CARBON



ML3150STCA

i	ML3100SS noce-walnut	ML3100SSCA carbon	ML3150ST noce-walnut	ML3150STCA carbon
↗ cm	95 x 49 x 144(h) cm			
	2 sportelli - 2 cassetti 2 doors - 2 drawers		1 sportello - 1 tramoggia - 2 cassetti 1 door - 1 hopper - 2 drawers	
	1.170 €		1.335 €	

# ML3202SS



ML3202SSCE

# ML3212SS



ML3212SSN



NOCE/WALNUT



CARBON



CENERE  
ASH GRAY

IT Mobili di servizio bassi doppi - struttura e pannelli in nobilitato - 2 cassetti portaposate di cui 1 con separatore - 2 sportelli con ripiano intermedio - ruote multidirezionali ø 50 mm. Optional tramoggia A260.

EN Low double service cabinets - melamine structure and panels - 2 cutlery drawers, 1 with separator - 2 doors with intermediate shelf - multidirectional wheels ø 50 mm. Optional hopper A260.

FR Meubles bas de service double - structure et panneaux en mélaminé - 2 tiroirs à couverts dont 1 avec séparateur - 2 portes avec étagère intermédiaire - roues multidirectionnelles ø 50 mm. Trémie A260 en option.



DE Niedrige Doppelservicemöbel - Struktur und Blenden aus Melamin - 2 Besteckschubladen, davon 1 mit Trennwand - 2 Türen mit Zwischenregal - Mehrwegräder ø 50 mm. Auf Wunsch Trichter A260.

IT Mobili di servizio alti doppi - struttura e pannelli in nobilitato - 2 cassetti portaposate di cui 1 con separatore - 2 sportelli con ripiano intermedio - ruote multidirezionali ø 50 mm. Optional tramoggia A260.

EN High double service cabinets - melamine structure and panels - 2 cutlery drawers, 1 with separator - 2 doors with intermediate shelf - multidirectional wheels ø 50 mm. Optional hopper A260.

FR Meubles hautes de service double - structure et panneaux en mélaminé - 2 tiroirs à couverts dont 1 avec séparateur - 2 portes avec étagère intermédiaire - roues multidirectionnelles ø 50 mm. Trémie A260 en option.

DE Hohe Doppelservicemöbel - Struktur und Blenden aus Melamin - 2 Besteckschubladen, davon 1 mit Trennwand - 2 Türen mit Zwischenregal - Mehrwegräder ø 50 mm. Auf Wunsch Trichter A260.

	ML3202SSN noce-walnut	ML3202SSCA carbon	ML3202SSCE cenere-ash gray	ML3212SSN noce-walnut	ML3212SSCA carbon	ML3212SSCE cenere-ash gray	A260
	90 x 48 x 87(h) cm			90 x 48 x 155(h) cm			Applicazione tramoggia Overprice hopper
	2 sportelli - 2 cassetti 2 doors - 2 drawers						
	985 €			1.185 €			180 €

# ML3204SS



ML3204SSCE

- IT** Mobili di servizio bassi tripli - struttura e pannelli in nobilitato - 3 cassetti portaposate di cui 2 con separatore - 2 sportelli con ripiano intermedio - 1 vano a giorno - ruote multidirezionali ø 50 mm. Optional tramoggia A260.
- EN** Low triple service cabinets - melamine structure and panels - 3 cutlery drawers, 2 with separator - 2 doors with intermediate shelf - 1 open compartment - multidirectional wheels ø 50 mm. Optional hopper A260.
- FR** Meubles bas de service triple - structure et panneaux mélaminés - 3 tiroirs à couverts, dont 2 avec séparateur - 2 portes avec étagère intermédiaire - 1 compartiment à jour - roues multidirectionnelles ø 50 mm. Trémie A260 en option.
- DE** Niedrige Trippelservicemöbel - Struktur und Blenden aus Melamin - 3 Besteckschubladen, davon 2 mit Trennwand - 2 Türen mit Zwischenregal - 1 offenes Fach - Mehrwegräder ø 50 mm. Auf Wunsch Trichter A260.

# ML3214SS



ML3214SSCA

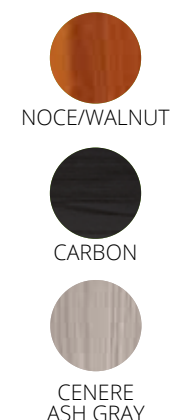

- IT** Mobili di servizio alti tripli - struttura e pannelli in nobilitato - 3 cassetti portaposate di cui 2 con separatore - 2 sportelli con ripiano intermedio - 1 vano a giorno - ruote multidirezionali ø 50 mm.
- EN** High triple service cabinets - melamine structure and panels - 3 cutlery drawers, 3 with separator - 2 doors with intermediate shelf - 1 open compartment - multidirectional wheels ø 50 mm.
- FR** Meubles de service hautes triple - structure et panneaux en mélaminé - 3 tiroirs à couverts dont 2 avec séparateur - 2 portes avec étagère intermédiaire - 1 compartiment à jour - roues multidirectionnelles ø 50 mm.
- DE** Hohe Trippelservicemöbel - Struktur und Blenden aus Melamin - 3 Besteckschubladen, davon 2 mit Trennwand - 2 Türen mit Zwischenregal - 1 offenes Fach - Mehrwegräder ø 50 mm.

	ML3204SSN noce-walnut	ML3204SSCA carbon	ML3204SSCE cenere-ash gray	A260
	136 x 48 x 87(h) cm			Applicazione tramoggia Overprice hopper
	2 sportelli - 3 cassetti - 1 vano a giorno 2 doors - 3 drawers - 1 open compartment			
	1.285 €			180 €

	ML3214SSN noce-walnut	ML3214SSCA carbon	ML3214SSCE cenere-ash gray
	136 x 48 x 155(h) cm		
	2 sportelli - 3 cassetti - 1 vano a giorno 2 doors - 3 drawers - 1 open compartment		
	1.555 €		

# ML3212SSP



ML3212SSPN

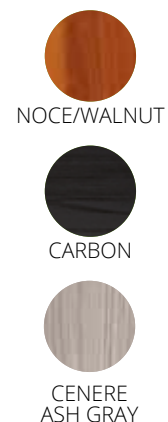

ML3212SSPCA

- IT** Mobili di servizio alti doppi - struttura e pannelli in nobilitato - struttura reggi pensili in acciaio plastificato - 2 pensili - 2 cassetti portaposate di cui 1 con separatore - 2 sportelli con ripiano intermedio - ruote multidirezionali  $\varnothing$  50 mm. Optional tramoggia A270.
- EN** High double service cabinets - melamine structure and panels - plastic-coated steel wall cabinets support structure - 2 wall cabinets - 2 cutlery drawers, 1 with separator - 2 doors with intermediate shelf - multidirectional wheels  $\varnothing$  50 mm. Optional hopper A270.
- FR** Meubles hautes de service double - structure et panneaux en mélaminé - 2 tiroirs à couverts dont 1 avec séparateur - 2 portes avec étagère intermédiaire - roues multidirectionnelles  $\varnothing$  50 mm. Trémie A270 en option.
- DE** Hohe Servicemöbel - Struktur und Blenden aus Melamin - kunststoffbeschichtete Stahl-Halterungen - 2 Hängeschränke - 2 Besteckschubladen, davon 1 mit Trennwand - 2 Türen mit Zwischenregal - Mehrwegräder  $\varnothing$  50 mm. Auf Wunsch Trichter A270.

i	ML3212SSPN noce-walnut	ML3212SSPCA carbon	ML3212SSPCE cenere-ash gray	A270
↗ cm	92 x 48 x 153(h) cm			
	2 pensili - 2 sportelli - 2 cassetti 2 wall cabinets - 2 doors - 2 drawers			Applicazione tramoggia Overprice hopper
	1.540 €			190 €

# ML3214SSP



ML3214SSPN

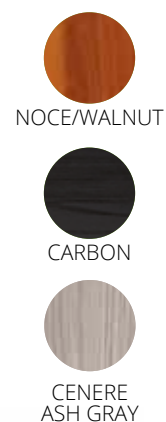

ML3214SSPCE

**IT** Mobili di servizio alti tripli - struttura e pannelli in nobilitato - struttura reggi pensili in acciaio plastificato - 3 pensili - 3 cassetti portaposate di cui 2 con separatore - 2 sportelli con ripiano intermedio - 1 vano a giorno - ruote multidirezionali  $\varnothing$  50 mm. Optional tramoggia A270.

**EN** High triple service cabinets - melamine structure and panels - plastic-coated steel wall cabinets support structure - 3 wall cabinets - 3 cutlery drawers, 2 with separator - 2 doors with intermediate shelf - 1 open compartment - multidirectional wheels  $\varnothing$  50 mm. Optional hopper A270.

**FR** Meubles de service hautes triple - structure et panneaux en mélaminé - structure de supports pour meubles à mur en acier plastifié - 3 tiroirs à couverts dont 2 avec séparateur - 2 portes avec étagère intermédiaire - 1 compartiment à jour - roues multidirectionnelles  $\varnothing$  50 mm. Trémie A270 en option.

**DE** Hohe Trippelservicemöbel - Struktur und Blenden aus Melamin - kunststoffbeschichtete Stahl-Halterungen - 3 Hängeschränke - 3 Besteckschubladen, davon 2 mit Trennwand - 2 Türen mit Zwischenregal - 1 offenes Fach - Mehrwegräder  $\varnothing$  50 mm. Auf Wunsch Trichter A270.

i	ML3214SSPN noce-walnut	ML3214SSPCA carbon	ML3214SSPCE cenere-ash gray	A270
↗ cm	137 x 48 x 153(h) cm			
	3 pensili - 2 sportelli - 3 cassetti - 1 vano a giorno 3 wall cabinets - 2 doors - 3 drawers - 1 open compartment			Applicazione tramoggia Overprice hopper
	1.865 €			190 €



# Carrelli di servizio in acciaio inox

STAINLESS STEEL  
SERVICE TROLLEYS  
CHARIOTS DE SERVICE EN ACIER INOX  
SERVICEWAGEN AUS EDELSTAHL

# CA1380 CA1381



CA1380

# CA1382 CA1383



CA1382

# CA1384 CA1385



CA1384



IT Struttura tubolare 20x20 mm in acciaio inox AISI 304 - ripiani in acciaio inox AISI 304 piegati, satinati, insonorizzati - paracolpi in gomma - ruote multidirezionali ø 125 mm.

EN Tubular structure 20x20 mm in stainless steel AISI 304 - AISI 304 stainless steel folded, satin-finished, soundproofed shelves - rubber shock absorber - multidirectional wheels ø 125 mm.

FR Structure tubulaire 20x20 mm en acier inox AISI 304 - étagères en acier inox AISI 304 pliées, satinées, insonorisées - butoirs en caoutchouc - roues multidirectionnelles ø 125 mm.

DE Rohrrahmen 20x20 mm aus Edelstahl AISI 304 - Gebogene, Schallgedämmte Ablageflächen aus Edelstahl AISI 304 mit satiniertes Oberfläche - Gummistoßschutz - Mehrwegräder ø 125 mm.

	CA1380	CA1381	CA1382	CA1383	CA1384	CA1385	A512
	91 x 57 x 172(h) cm	111 x 57 x 172(h) cm	91 x 57 x 96(h) cm	111 x 57 x 96(h) cm	91 x 57 x 96(h) cm	111 x 57 x 96(h) cm	Ruote con freno Wheels with catch Roues avec frein Räder mit Bremse
	4		2		3		
	80 x 50 cm	100 x 50 cm	80 x 50 cm	100 x 50 cm	80 x 50 cm	100 x 50 cm	
	80 Kg		80 Kg		80 Kg		
	605 €	680 €	355 €	390 €	450 €	520 €	10 € cad./each

Carrelli di servizio in acciaio inox  
Stainless steel service trolleys

CA1390  
CA1391

CA1410  
CA1411

CA1412  
CA1413  
CA1414



CA1390



CA1410



CA1412

IT Struttura tubolare  $\varnothing$  25 mm in acciaio inox AISI 304 - ripiani in acciaio inox AISI 304, stampati in forma di vassoio con bordi arrotondati e alto spessore, insonorizzati e con finitura satinata - paracolpi in gomma - ruote multidirezionali  $\varnothing$  125 mm.

EN Tubular structure  $\varnothing$  25 mm in stainless steel AISI 304 - AISI 304 stainless steel shelves, tray-shaped with rounded edges and high thickness, soundproofed and with satin finish - rubber shock absorber - multidirectional wheels  $\varnothing$  125 mm.

	CA1390	CA1391	CA1410	CA1411	CA1412	CA1413	CA1414	A512
	90 x 60 x 94(h) cm	110 x 60 x 94(h) cm	90 x 60 x 104(h) cm	110 x 60 x 104(h) cm	100 x 70 x 94(h) cm	110 x 70 x 94(h) cm	128 x 70 x 94(h) cm	
	2		3		2			
	80 x 50 cm	100 x 50 cm	80 x 50 cm	100 x 50 cm	90 x 60 cm	100 x 60 cm	120 x 60 cm	
	100 Kg		100 Kg		100 Kg			
	340 €	380 €	450 €	495 €	415 €	450 €	540 €	10 € cad./each

CA1415  
CA1416  
CA1417



CA1415

CA1424  
CA1425



CA1424

CA1426  
CA1427



CA1426



FR Structure tubulaire  $\varnothing$  25 mm en acier inox AISI 304 - étagères en acier inox AISI 304, moulées en forme de plateau à bords arrondis et de grande épaisseur, insonorisées et satinées - butoirs en caoutchouc - roues multidirectionnelles  $\varnothing$  125 mm.

DE Rohrrahmen  $\varnothing$  25 mm aus Edelstahl AISI 304 - Schallgedämmte Ablageflächen aus Edelstahl AISI 304, Tablett förmig bedruckt mit abgerundeten Kanten und satinierter Oberfläche - Gummistoßschutz-Mehrwegräder  $\varnothing$  125 mm.

	CA1415	CA1416	CA1417	CA1424	CA1425	CA1426	CA1427	A512
								
	100 x 70 x 104(h) cm	110 x 70 x 104(h) cm	128 x 70 x 104(h) cm	90 x 60 x 140(h) cm	110 x 60 x 140(h) cm	90 x 60 x 170(h) cm	110 x 60 x 170(h) cm	
	3			4		5		
	90 x 60 cm	100 x 60 cm	120 x 60 cm	80 x 50 cm	100 x 50 cm	80 x 50 cm	100 x 50 cm	
	100 Kg			100 Kg		100 Kg		
	550 €	620 €	770 €	580 €	650 €	715 €	790 €	10 € cad./each

# CA1430 CA1430L60

# CA1431 CA1431L60



CA1430

CA1431

**IT** Carrelli di servizio inox per trasporto pesante. Struttura tubolare tonda  $\varnothing$  25 mm, in acciaio inox AISI 304 - ripiani in acciaio inox AISI 304, stampati in forma di vassoio con bordi arrotondati e alto spessore, insonorizzati e con finitura satinata - paracolpi in gomma - ruote multidirezionali  $\varnothing$  125 mm.

**EN** Stainless steel service trolleys for heavy transport. Tubular structure  $\varnothing$  25 mm in stainless steel AISI 304 - AISI 304 stainless steel shelves, tray-shaped with rounded edges and high thickness, soundproofed and with satin finish - rubber shock absorber - multidirectional wheels  $\varnothing$  125 mm.

	CA1430	CA1430L60	CA1431	CA1431L60	A517
	110 x 60 x 100(h) cm	110 x 70 x 100(h) cm	110 x 60 x 100(h) cm	110 x 70 x 100(h) cm	
	2		3		Ruote con freno Wheels with catch Roues avec frein Räder mit Bremse
	100 x 50 cm	100 x 60 cm	100 x 50 cm	100 x 60 cm	
	150 Kg		150 Kg		
	585 €	660 €	710 €	805 €	14 € cad./each

# CA1432 CA1432L60



CA1432

# CA1433 CA1433L60



CA1433



FR Chariots de service inox pour le transport de poids. Structure tubulaire ronde  $\varnothing$  25 mm en acier inox AISI 304 - étagères en acier inox AISI 304, moulées en forme de plateau à bords arrondis et de grande épaisseur, insonorisées et satinées - butoirs en caoutchouc - roues multidirectionnelles  $\varnothing$  125 mm.

DE Servicewagen aus Edelstahl für Schwerlasten. Runder Rohrrahmen  $\varnothing$  25 mm, aus Edelstahl AISI 304 - Schallgedämmte Ablageflächen aus Edelstahl AISI 304, Tablett förmig bedruckt mit abgerundeten Kanten und satinierter Oberfläche - Gummistoßschutz- Mehrwegräder  $\varnothing$  125 mm.

	CA1432	CA1432L60	CA1433	CA1433L60	A517
	110 x 60 x 130(h) cm	110 x 70 x 130(h) cm	110 x 60 x 160(h) cm	110 x 70 x 160(h) cm	 Ruote con freno Wheels with catch Roues avec frein Räder mit Bremse
	4		5		
	100 x 50 cm	100 x 60 cm	100 x 50 cm	100 x 60 cm	
	150 Kg		150 Kg		
	880 €	985 €	1.000 €	1.190 €	14 € cad./each



# CA1392P CA1393P



CA1393P

# CA1394P CA1395P



CA1395P

**IT** Carrelli di servizio inox per trasporto pesante. Struttura tubolare 25x25 mm in acciaio inox AISI 304 - ripiani in acciaio inox AISI 304, piegati con omega di rinforzo, satinati e insonorizzati - paracolpi in gomma - ruote multidirezionali  $\varnothing$  125 mm.

**FR** Chariots de service inox pour le transport de poids. Structure tubulaire 25x25 mm en acier inox AISI 304 - étagères en acier inox AISI 304 pliées avec renforcement oméga, satinées et insonorisées - butoirs en caoutchouc - roues multidirectionnelles  $\varnothing$  125 mm.

**EN** Stainless steel service trolleys for heavy transport. Tubular structure 25x25 mm in stainless steel AISI 304 - AISI 304 stainless steel, folded shelves with support omega, satin-finished and soundproofed - rubber shock absorber - multidirectional wheels  $\varnothing$  125 mm.

**DE** Servicewagen aus Edelstahl für Schwerlasten. Rohrrahmen 25x25 mm aus Edelstahl AISI 304 - mit Omega Verstärkung gebogene, schallgedämmte Ablageflächen aus Edelstahl AISI 304 mit satiniertes Oberfläche - Gummistoßschutz - Mehrwegräder  $\varnothing$  125 mm.





	CA1392P	CA1393P	CA1394P	CA1395P	A514
	92 x 67 x 98(h) cm	112 x 67 x 98(h) cm	92 x 67 x 98(h) cm	112 x 67 x 98(h) cm	
	2		3		Ruote con freno Wheels with catch Roues avec frein Räder mit Bremse
	80 x 60 cm	100 x 60 cm	80 x 60 cm	100 x 60 cm	
	200 Kg		200 Kg		
	520 €	550 €	690 €	740 €	16 € cad./each

# CA1386 CA1387



CA1387

- IT** Carrello portabacinelle con struttura tubolare 20x20 mm in acciaio inox AISI 304 - piano inferiore in acciaio inox AISI 304, piegato e insonorizzato - paracolpi in gomma - ruote multidirezionali ø 125 mm. Bacinelle escluse.
- EN** Containers trolley with tubular frame 20x20 mm in stainless steel AISI 304 - lower level in stainless steel AISI 304, folded and soundproofed - rubber shock absorber - multidirectional wheels ø 125 mm. Containers not included.
- FR** Chariot porte-bacs avec structure tubulaire 20x20 mm en acier inox AISI 304 - niveau inférieur en acier inox AISI 304, plié et insonorisé - butoir en caoutchouc - roues multidirectionnel ø 125 mm. Bacs non compris.
- DE** Behälterhalterwagen mit Rohrrahmen 20x20 mm aus Edelstahl AISI 304 - vorgeformte, schallgedämmte Bodenfläche aus Edelstahl - Gummistoßschutz - Mehrwegräder ø 125 mm. Behälter nicht enthalten.

	CA1386	CA1387	A512
	77 x 62 x 97(h) cm	110 x 62 x 97(h) cm	
	2		Ruote con freno Wheels with catch Roues avec frein Räder mit Bremse
	2x GN1/1 o/or 4x GN1/2 o/or 6x GN1/3	3x GN1/1 o/or 6x GN1/2 o/or 9x GN1/3	
	100 Kg		
	290 €	370 €	10 € cad./each

Carrelli in acciaio inox portabacinelle  
Stainless steel containers trolleys







# CA1165



CA1165

8 PIASTRE EUTETTICHE  
REFRIGERANTI  
8 REFRIGERANT EUTECTIC  
PLATES

- IT** Carrello di servizio in acciaio inox con 8 piastre eutettiche refrigeranti incluse. Struttura tubolare 20x20 mm in acciaio inox AISI 304 - vasca e griglia in acciaio inox AISI 304 - rubinetto di scarico - coperchio in plexiglass 150(h) mm. Bacinelle non incluse nel prezzo.
- EN** Stainless steel service trolley with 8 refrigerated electric plates. Tubular structure 20x20 mm in stainless steel AISI 304 - stainless steel AISI 304 bowl and grid - drain tap - plexiglas lid 150(h) mm - Containers not included in the price.
- FR** Chariot de service en acier inox avec 8 plaques eutectiques réfrigérées incluses. Structure tubulaire 20x20 mm en acier inox AISI 304 - cuve et grille en acier inox - robinet de vidange - couvercle en plexiglas 150(h) mm. Bacs non compris dans le prix.
- DE** Edelstahl-Servicewagen mit 8 elektrischen Kühlplatten inklusive. Rohrrahmen aus Edelstahl AISI 304 20x20 mm - AISI 304 Edelstahlwanne und Gitter - Entleerungshahn - Plexiglasdeckel 150(h) mm. Behälter nicht im Preis inbegriffen.

	CA1165	A512
	108 x 57 x 104(h) cm	Ruote con freno Wheels with catch Roues avec frein Räder mit Bremse
	2	
	82,5 x 41,3 x 10(h) cm	
	5x GN1/4 e 5x GN1/6 - Max 65(h) mm	
	80 Kg	
	995 €	10 € cad./each

Carrelli di servizio in acciaio inox  
Stainless steel service trolleys

## CA1390C - CA1391C



CA1390C

**IT** Carrello di servizio con cupola. Struttura tubolare  $\varnothing$  25 mm in acciaio inox AISI 304 - ripiani in acciaio inox AISI 304, stampati, satinati e insonorizzati - cupola in plexiglass semicircolare apribile su due lati - paracolpi in gomma - ruote multidirezionali  $\varnothing$  125 mm.

**EN** Service trolley with dome. Tubular structure  $\varnothing$  25 mm in stainless steel AISI 304 - stainless steel AISI 304 folded, satin-finished, soundproofed shelves - half-circle dome in Plexiglas that opens on two sides - rubber shock absorber - multidirectional wheels  $\varnothing$  125 mm.

**FR** Chariot de service avec clochette. Structure tubulaire  $\varnothing$  25 mm en acier inox AISI 304 - étagères en acier inox AISI 304 moulées, satinées, insonorisées - clochette en plexiglas semi-circulaire s'ouvrant sur deux côtés - butoir en caoutchouc - roues multidirectionnelles  $\varnothing$  125 mm.

**DE** Servicewagen für Kuchen. Rohrrahmen  $\varnothing$  25 mm aus Edelstahl AISI 304 - vorgeformte schallgedämmte Ablageflächen aus Edelstahl AISI 304 mit satiniertes Oberfläche - zweiseitig aufklappbare, halbrunde Plexiglashaube - Gummistoßschutz- Mehrwegräder  $\varnothing$  125 mm.

	CA1390C	CA1391C	A512
	90 x 60 x 109(h) cm	110 x 60 x 109(h) cm	
	2		Ruote con freno Wheels with catch Roues avec frein Räder mit Bremse
	100 Kg		
	640 €	690 €	10 € cad./each

## CA1396









CA1396

**IT** Carrello di servizio in acciaio inox per sbarazzo. Struttura tubolare 20x20 mm in acciaio inox AISI 304 - vasche insonorizzate in acciaio inox AISI 304, 65(h) mm - ruote multidirezionali  $\varnothing$  125 mm.

**EN** Stainless steel service trolley for disposal. Tubular structure 20x20 mm in stainless steel AISI 304 - stainless steel AISI 304 soundproofed bowls, 65(h) mm - multidirectional wheels  $\varnothing$  125 mm.

**FR** Chariot de service en acier inox pour le rangement. Structure tubulaire 20x20 mm en acier inox AISI 304 - cuve en acier inox AISI 304 insonorisées, 65(h) mm - roues multidirectionnelles  $\varnothing$  125 mm.

**DE** Servicewagen aus Edelstahl zum Abräumen. Rohrrahmen 20x20 mm aus Edelstahl AISI 304 - schallgedämmte Wanne aus Edelstahl AISI 304, 65(h) mm - Mehrwegräder  $\varnothing$  125 mm.

	CA1396	A512
	91 x 57 x 97(h) cm	
	2	Ruote con freno Wheels with catch Roues avec frein Räder mit Bremse
	90 x 50 cm	
	2x Max 65(h) mm	
	80 Kg	
	440 €	10 € cad./each

# CA1388



CA1388

# CA1389



CA1389

**IT** Carrello di servizio in acciaio inox per sbarazzo. Struttura tubolare in acciaio inox AISI 304, 20x20 mm - vasca in acciaio inox AISI 304 - piano inferiore inox piegato - ruote multidirezionali ø 125 mm.

**EN** Stainless steel service trolley for disposal. Tubular structure in stainless steel AISI 304, 20x20 mm - stainless steel AISI 304 bowl - lower folded stainless steel shelf- multidirectional wheels ø 125 mm.

**FR** Chariot de service en acier inox pour le rangement. Structure tubulaire en acier inox AISI 304, 20x20 mm - cuve en acier inox AISI 304 - plateau inférieur courbé en acier inox - roues multidirectionnelles ø 125 mm.







**DE** Servicewagen aus Edelstahl zum Abräumen. Rohrrahmen aus Edelstahl AISI 304, 20x20 mm - Wanne aus Edelstahl AISI 304 - Bodenfläche aus gebogenem Edelstahl - Mehrwegräder ø 125 mm.

**IT** Carrello di servizio in acciaio inox per sbarazzo. Struttura tubolare in acciaio inox AISI 304, 20x20 mm - vasche in acciaio inox AISI 304 insonorizzate 150(h) mm - ruote multidirezionali ø 125 mm.

**EN** Stainless steel service trolley for disposal. Tubular structure in stainless steel AISI 304, 20x20 mm - stainless steel AISI 304 soundproofed bowls 150(h) mm - multidirectional wheels ø 125 mm.

**FR** Chariot de service en acier inox pour le rangement. Structure tubulaire en acier inox AISI 304, 20x20 mm - cuve en acier inox AISI 304 insonorisées 150(h) mm - roues multidirectionnelles ø 125 mm.

**DE** Servicewagen aus Edelstahl zum Abräumen. Rohrrahmen aus Edelstahl AISI 304, 20x20 mm - schallgedämmte Wanne aus Edelstahl AISI 304 150(h) mm - Mehrwegräder ø 125 mm.

	CA1388	CA1389	A512
	101 x 57 x 97(h) cm		Ruote con freno Wheels with catch Roues avec frein Räder mit Bremse
	2		
	90 x 50 cm		
	1x Max 150(h) mm	2x Max 150(h) mm	
	80 Kg	80 Kg	
	445 €	495 €	10 € cad./each

Carrelli di servizio in acciaio inox per sbarazzo  
 Stainless steel service trolleys for disposal

# CA1390S - CA1391S

# CA1391S2



CA1390S

\* Sacchi non inclusi  
Bags not included



CA1391S2

\* Sacchi non inclusi  
Bags not included

**IT** Carrelli portarifiuti. Carrelli di servizio in acciaio inox. Struttura tubolare  $\varnothing$  25 mm in acciaio inox AISI 304 - ripiani in acciaio inox AISI 304 con fori per sacchi portarifiuti ( $\varnothing$  20 cm) - paracolpi in gomma - ruote multidirezionali  $\varnothing$  125 mm. Sacchi non inclusi.

**FR** Récipient à déchets. Chariots de service en acier inox Structure tubulaire  $\varnothing$  25 mm en acier inox AISI 304 - étagères en acier inox AISI 304 avec trous pour sacs à déchets ( $\varnothing$  20 cm) - butoir en caoutchouc - roues multidirectionnelles  $\varnothing$  125 mm. Sacs non fournis.

**EN** Garbage trolley. Stainless steel service trolleys. Tubular structure  $\varnothing$  25 mm in stainless steel AISI 304 - stainless steel AISI 304 shelves with holes for garbage bags ( $\varnothing$  20 cm) - rubber stop - multidirectional wheels  $\varnothing$  125 mm. Bags not included.

**DE** Abfallwagen. Servicewagen aus Edelstahl. Rohrrahmen  $\varnothing$  25 mm aus Edelstahl AISI 304 - Ablageflächen aus Edelstahl AISI 304 mit Löchern für Abfallsäcke ( $\varnothing$  20 cm) - Gummistoßschutz - Mehrwegräder  $\varnothing$  125 mm. Säcke nicht enthalten.

	CA1390S	CA1391S	CA1391S2	A512
	90 x 60 x 94(h) cm	110 x 60 x 94(h) cm		Ruote con freno Wheels with catch Roues avec frein Räder mit Bremse
	2			
	80 x 50 cm	100 x 50 cm		
	100 Kg			
	400 €	475 €	520 €	10 € cad./each

# CP1008



CP1008

IT Carrelli di servizio multiuso in plastica con montanti in alluminio anodizzato.

EN Multipurpose plastic service trolleys with anodised aluminium uprights.

# CP1010

OPTIONAL  
A1002

OPTIONAL  
A1001



CP1010

FR Chariots polyvalente en plastique avec montants en aluminium anodisé.

DE Mehrzweck-Servicewagen aus Kunststoff mit Trägern aus eloxiertem Aluminium.

i	CP1008	CP1010
↗ cm	85 x 43 x 95(h) cm	102 x 50 x 96(h) cm
N.	3	
MAX Kg	40 Kg	
	110 €	180 €

i	A1001	A1002
↗ cm	23,5 x 33,5 x 18(h) cm	23 x 36,5 x 50,5(h) cm
	Cestino piccolo / Small basket Petit panier / Klein Korb	Cestino grande / Big basket Grand panier / Gros Korb
	15 €	30 €

Carrelli di servizio multiuso in plastica  
Multipurpose plastic service trolleys



# Carrelli ed Espositori refrigerati e termici in legno

WOODEN REFRIGERATED AND  
HEATED TROLLEYS AND DISPLAYS  
CHARIOTS ET PRÉSENTOIRS EN  
BOIS RÉFRIGÉRÉS ET THERMIQUES  
KÜHL- UND HEIZWAGEN  
UND -DISPLAYS AUS HOLZ

# CLR2788N



CLR2788NBTCA

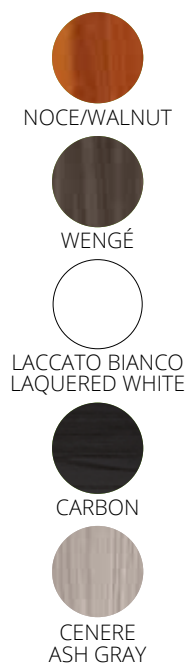
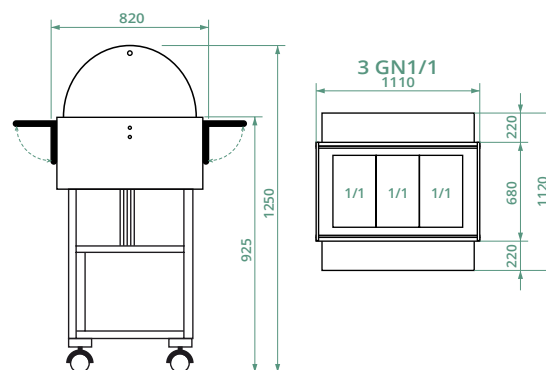

**IT** Carrelli refrigerati in legno con cupola. Struttura in legno multistrato di betulla - cupola semicircolare in plexiglass - refrigerazione statica - modelli con 2 mensole ripieghevoli - ruote  $\varnothing$  75 mm di cui due con freno. Bacinelle escluse - le temperature di lavoro indicate sono da considerarsi con coperchi posizionati.

**EN** Wooden refrigerated trolleys with dome. Multi-layered birch wood structure - half-round Plexiglas dome - static refrigeration - two foldable shelves models -  $\varnothing$  75 mm wheels, two of which with brakes. Basins excluded - the indicated working temperatures are to be considered with positioned lids.

**FR** Chariots réfrigérés en bois avec clochette. Structure en multicouche de bouleau - clochette en plexiglas semi-circulaire - réfrigération statique - modèles avec 2 étagères escamotables - roues de  $\varnothing$  75 mm, dont deux avec freins. Bacs non compris - les températures de travail indiquées sont à considérer avec couvercles en place.

**DE** Kühlwagen aus Holz mit Haube. Birkensperrholzstruktur - halbrunde Plexiglashaube - statische Kühlung - Modelle mit 2 Falflächen - räder  $\varnothing$  75 mm, davon zwei mit Bremsen. Behälter nicht enthalten - die angegebenen Arbeitstemperaturen sind bei aufgesetzten Deckeln zu verstehen.

CLR										
	2788N noce-walnut	2788NW wengé	2788NCA carbon	2788NCE cenere ash gray	2788NB laccato bianco laquered white	2788NBT noce-walnut	2788NBTW wengé	2788NBTCA carbon	2788NBTCE cenere ash gray	2788NBTB laccato bianco laquered white
	340 W									
	230V/1N/50 Hz									
	+2°C +10°C					-5°C +5°C				
	R600a									
	3x GN1/1 - Max 150(h) mm									
	3.660 €			3.795 €		3.860 €			4.390 €	

Carrelli refrigerati in legno  
Wooden refrigerated trolleys

OPTIONAL



# CLR2787N



CLR2787NBT

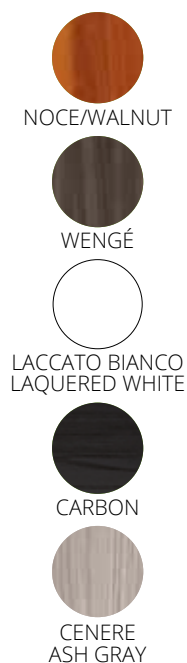
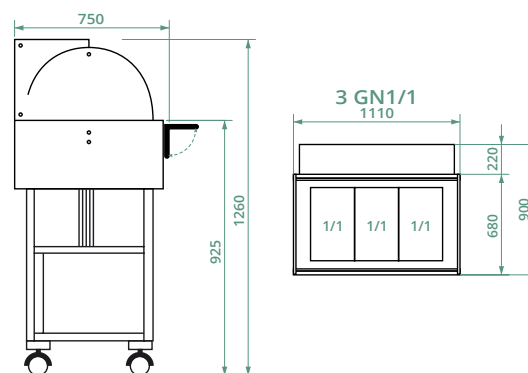

**IT** Carrelli refrigerati in legno con cupola. Struttura in legno multistrato di betulla - cupola semicircolare in plexiglass - refrigerazione statica - modelli disponibili con 1 mensola ripieghevole e 1 piano di appoggio - ruote  $\varnothing$  75 mm di cui due con freno. Bacinelle escluse - le temperature di lavoro indicate sono da considerarsi con coperchi posizionati.

**FR** Chariots réfrigérés en bois avec clochette. Structure en multicouche de bouleau - clochette en plexiglas semi-circulaire - réfrigération statique - modèles avec 1 étagère et plan de travail - roues de  $\varnothing$  75 mm, dont deux avec freins. Bacs no compris - les températures de travail indiquées sont à considérer avec couvercles en place.

**EN** Wooden refrigerated trolleys with dome. Multi-layered birch wood structure - half-round Plexiglas dome - static refrigeration - models with foldable shelf and support base -  $\varnothing$  75 mm wheels, two of which with brakes. Containers not included - the operating temperatures listed are to be considered with lids on.

**DE** Kühlwagen aus Holz mit Haube. Birkensperrholzstruktur - halbrunde Plexiglashaube - statische Kühlung - Modelle mit 1 Faltfläche und 1 Ablagefläche - räder  $\varnothing$  75 mm, davon zwei mit Bremsen. Behälter nicht enthalten - die angegebenen Arbeitstemperaturen sind bei aufgesetzten Deckeln zu verstehen.

CLR										
	2787N noce-walnut	2787NW wengé	2787NCA carbon	2787NCE cenere ash gray	2787NB laccato bianco laquered white	2787NBT noce-walnut	2787NBTW wengé	2787NBTCA carbon	2787NBTCE cenere ash gray	2787NBTB laccato bianco laquered white
	340 W									
	230V/1N/50 Hz									
	+2°C +10°C					-5°C +5°C				
	R600a									
	3x GN1/1 - Max 150(h) mm									
	3.670 €			3.785 €		3.940 €			4.345 €	

# CLR2786N



CLR2786NBTB

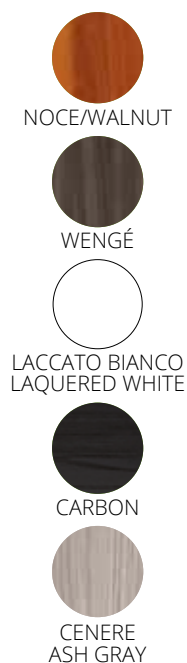
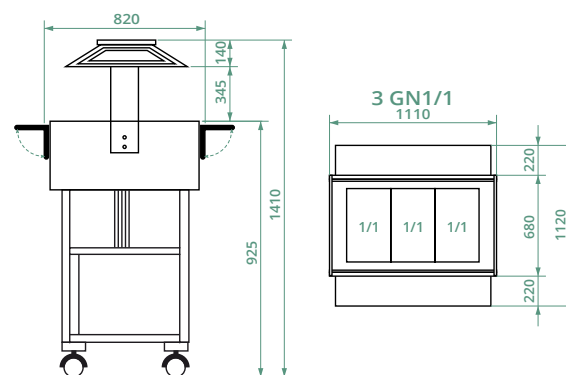

**IT** Carrelli refrigerati in legno. Struttura in legno multistrato di betulla - cupola in plexiglass - refrigerazione statica - 2 mensole ripieghevoli - 1 luce al neon - ruote  $\varnothing$  75 mm di cui due con freno. Bacinelle escluse - le temperature di lavoro indicate sono da considerarsi con coperchi posizionati.

**EN** Refrigerated wooden trolleys. Multi-layered birch wood structure - half-round Plexiglas dome - static refrigeration - 2 foldable shelves - 1 neon light -  $\varnothing$  75 mm wheels, two of which with brakes. Containers not included - the operating temperatures listed are to be considered with lids on.

**FR** Chariots réfrigérés en bois. Structure en multicouche de bouleau - clochette en plexiglas - réfrigération statique - 2 étagères escamotables - 1 lampe néon - roues de  $\varnothing$  75 mm, dont deux avec freins. Bacs non compris - les températures de travail indiquées sont à considérer avec couvercles en place.

**DE** Kühlwagen aus Holz. Birkensperrholzstruktur - Plexiglashaube - statische Kühlung - 2 Faltflächen - 1 Neonlampe - räder  $\varnothing$  75 mm, davon zwei mit Bremsen. Behälter nicht enthalten - die angegebenen Arbeitstemperaturen sind bei aufgesetzten Deckeln zu verstehen.

CLR										
	2786N noce-walnut	2786NW wengé	2786NCA carbon	2786NCE cenere ash gray	2786NB laccato bianco laquered white	2786NBT noce-walnut	2786NBTW wengé	2786NBTCA carbon	2786NBTCE cenere ash gray	2786NBTB laccato bianco laquered white
	340 W									
	230V/1N/50 Hz									
	+2°C +10°C					-5°C +5°C				
	R600a									
	3x GN1/1 - Max 150(h) mm									
	3.845 €			4.120 €		4.100 €			4.340 €	

OPTIONAL



# ELR2827



ELR2827

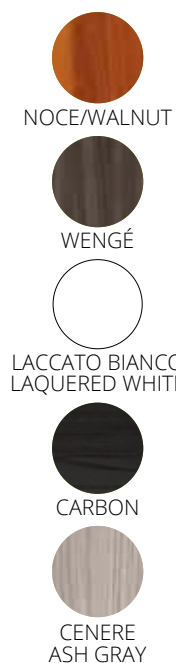
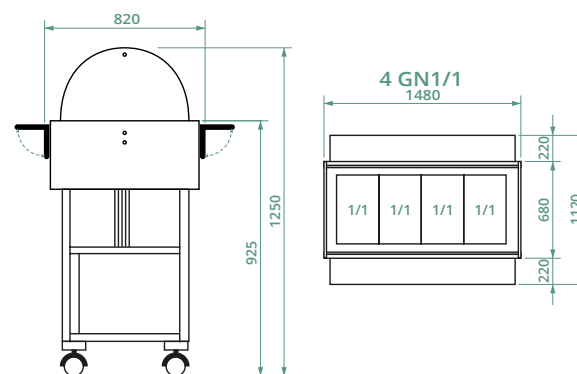

**IT** Espositori refrigerati in legno con cupola. Struttura in legno multistrato di betulla - cupola semicircolare in plexiglass - refrigerazione statica - disponibili con 2 mensole ripieghevoli - ruote  $\varnothing$  75 mm di cui due con freno. Bacinelle escluse - le temperature di lavoro indicate sono da considerarsi con coperchi posizionati.

**EN** Refrigerated wooden displays with dome. Multi-layered birch wood structure - half-round Plexiglas dome - static refrigeration - two foldable shelves models -  $\varnothing$  75 mm wheels, two of which with brakes. Containers not included - the operating temperatures listed are to be considered with lids on.

**FR** Présentoirs réfrigérés en bois avec clochette. Structure en multicouche de bouleau - clochette en plexiglas semi-circulaire - réfrigération statique - modèles avec 2 étagères escamotables - roues de  $\varnothing$  75 mm, dont deux avec freins. Bacs non compris - les températures de travail indiquées sont à considérer avec couvercles en place.

**DE** Kühlvitrinen aus Holz mit Haube. Birkensperrholzstruktur - halbrunde Plexiglashaube - statische Kühlung - 2 Faltflächen - räder  $\varnothing$  75 mm, davon zwei mit Bremsen. Behälter nicht enthalten - die angegebenen Arbeitstemperaturen sind bei aufgesetzten Deckeln zu verstehen.

ELR										
i	2827 noce-walnut	2827W wengé	2827CA carbon	2827CE cenere ash gray	2827B laccato bianco laquered white	2827BT noce-walnut	2827BTW wengé	2827BTCA carbon	2827BTCE cenere ash gray	2827BTB laccato bianco laquered white
⚡	340 W									
1 Ph	230V/1N/50 Hz									
🌡️	+2°C +10°C					-5°C +5°C				
🔥	R600a									
🍽️	4x GN1/1 - Max 150(h) mm									
	3.880 €			4.115 €		4.230 €			4.410 €	

# ELR2826



ELR2826BTW

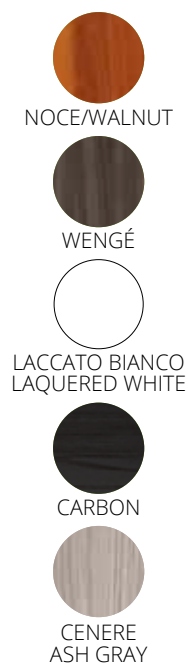
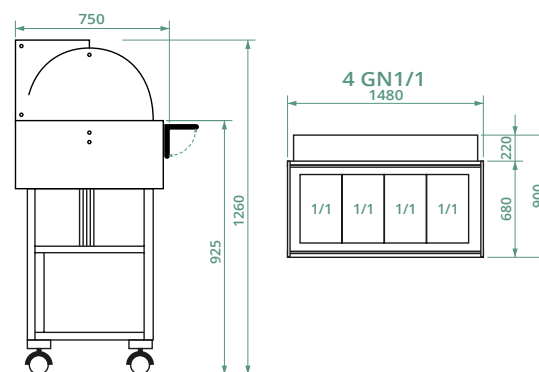

**IT** Espositori refrigerati in legno con cupola. Struttura in legno multistrato di betulla - cupola semicircolare in plexiglass - refrigerazione statica - disponibili con 1 mensola ripieghevole e 1 piano di appoggio - ruote  $\varnothing$  75 mm di cui due con freno. Bacinelle escluse - le temperature di lavoro indicate sono da considerarsi con coperchi posizionati.

**EN** Refrigerated wooden displays with dome. Multi-layered birch wood structure - half-round Plexiglas dome - static refrigeration - models with 1 foldable shelf and 1 support base -  $\varnothing$  75 mm wheels, two of which with brakes. Containers not included - the operating temperatures listed are to be considered with lids on.

**FR** Présentoirs réfrigérés en bois avec clochette. Structure en multicouche de bouleau - clochette en plexiglas semi-circulaire - réfrigération statique - avec 1 étagère escamotable et plan de travail - roues de  $\varnothing$  75 mm, dont deux avec freins. Bacs non compris - les températures de travail indiquées sont à considérer avec couvercles en place.

**DE** Kühlvitrinen aus Holz mit Haube. Birkenperrholzstruktur - halbrunde Plexiglashaube - statische Kühlung - Modelle mit 1 Ablagefläche und 1 Ablagefläche - räder  $\varnothing$  75 mm, davon zwei mit Bremsen. Behälter nicht enthalten - die angegebenen Arbeitstemperaturen sind bei aufgesetzten Deckeln zu verstehen.

ELR										
i	2826 noce-walnut	2826W wengé	2826CA carbon	2826CE cenere ash gray	2826B laccato bianco laquered white	2826BT noce-walnut	2826BTW wengé	2826BTCA carbon	2826BTCE cenere ash gray	2826BTB laccato bianco laquered white
⚡	340 W									
1 Ph	230V/1N/50 Hz									
🌡️	+2°C +10°C					-5°C +5°C				
🔥	R600a									
🍽️	4x GN1/1 - Max 150(h) mm									
	3.890 €			4.050 €		4.160 €			4.320 €	

OPTIONAL



# ELR2825



ELR2825W

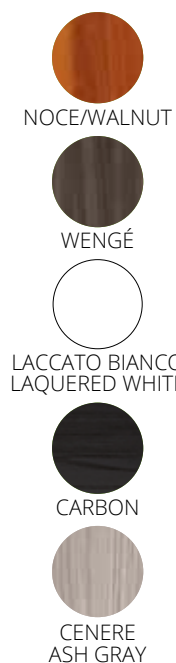
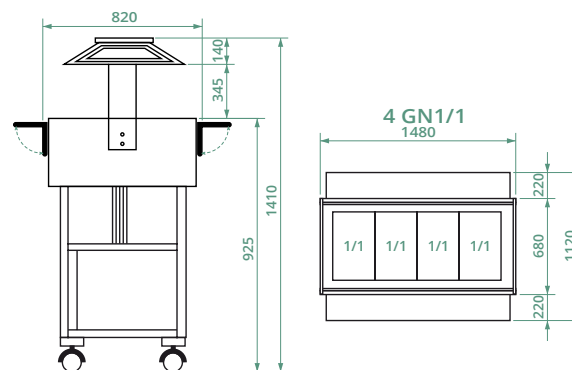

**IT** Espositori refrigerati in legno. Struttura in legno multistrato di betulla - cupola in plexiglass - refrigerazione statica - 2 mensole ripieghevoli - 1 luce al neon - ruote  $\varnothing$  75 mm di cui due con freno. Bacinelle escluse - le temperature di lavoro indicate sono da considerarsi con coperchi posizionati.

**EN** Refrigerated wooden displays with neon light. Multi-layered birch wood structure - Plexiglas dome - static refrigeration - 2 foldable shelves - 1 neon light -  $\varnothing$  75 mm wheels, two of which with brakes. Containers not included - the operating temperatures listed are to be considered with lids on.

**FR** Présentoirs réfrigérés en bois avec lampe néon. Structure en multicouche de bouleau - clochette en plexiglas - réfrigération statique - 2 étagères escamotables - 1 lampe néon - roues de  $\varnothing$  75 mm, dont deux avec freins. Bacs non compris - les températures de travail indiquées sont à considérer avec couvercles en place.

**DE** Kühlvitrinen aus Holz mit Neonlampe. Birkensperrholzstruktur - Plexiglashaube - statische Kühlung - 2 Faltflächen - 1 Neonlampe - räder  $\varnothing$  75 mm, davon zwei mit Bremsen. Behälter nicht enthalten - die angegebenen Arbeitstemperaturen sind bei aufgesetzten Deckeln zu verstehen.

ELR										
i	2825 noce-walnut	2825W wengé	2825CA carbon	2825CE cenere ash gray	2825B laccato bianco laquered white	2825BT noce-walnut	2825BTW wengé	2825BTCA carbon	2825BTCE cenere ash gray	2825BTB laccato bianco laquered white
⚡	340 W									
🔌 1 Ph	230V/1N/50 Hz									
🌡️	+2°C +10°C					-5°C +5°C				
🔥	R600a									
🍷	4x GN1/1 - Max 150(h) mm									
	4.070 €			4.310 €		4.430 €			4.670 €	

# CL2777N



CL2777NCA

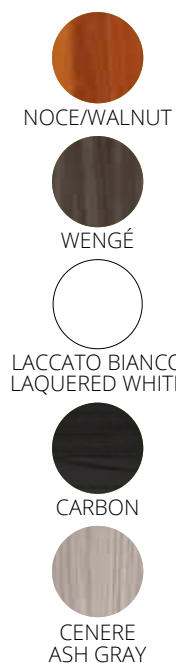
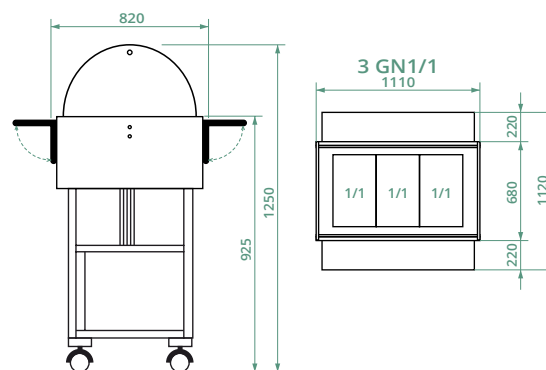

**IT** Carrelli termici a bagnomaria in legno, con cupola. Struttura in legno multistrato di betulla - cupola semicircolare in plexiglass - riscaldato con resistenza elettrica - disponibili con 2 mensole ripieghevoli - ruote  $\varnothing$  75 mm di cui due con freno. Bacinelle escluse - le temperature di lavoro indicate sono da considerarsi con coperchi posizionati.

**EN** Wooden heated bain-marie trolleys with dome. Multi-layered birch wood structure - half-round Plexiglas dome - electric heating element - available with two foldable shelves -  $\varnothing$  75 mm wheels, two of which with brakes. Containers not included - the operating temperatures listed are to be considered with lids on.

**FR** Chariots bain-marie chauffants en bois avec clochette. Structure en multicouche de bouleau - clochette en plexiglas semi-circulaire - chauffé par résistance électrique - disponibles avec 2 étagère escamotable - roues de  $\varnothing$  75 mm, dont deux avec freins. Bacs non compris - les températures de travail indiquées sont à considérer avec couvercles en place.

**DE** Bain-Marie Heizwagen aus Holz mit Haube. Birkensperrholzstruktur - halbrunde Plexiglashaube - mit elektrischem Heizstab beheizt - mit 2 Faltflächen - räder  $\varnothing$  75 mm, davon zwei mit Bremsen. Behälter nicht enthalten - die angegebenen Arbeitstemperaturen sind bei aufgesetzten Deckeln zu verstehen.

	CL				
	2777N noce-walnut	2777NW wengé	2777NCA carbon	2777NCE cenere-ash gray	2777NB laccato bianco laquered white
	2000 W				
 1 Ph	230V/1N/50 Hz				
	+30°C +90°C				
	3x GN1/1 - Max 150(h) mm				
	2.715 €				2.830 €

Carrelli termici a bagnomaria in legno  
Wooden bain-marie trolleys

OPTIONAL



# CL2778N



CL2778N

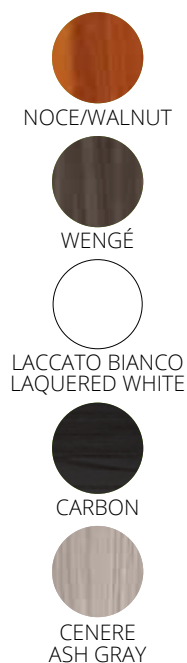
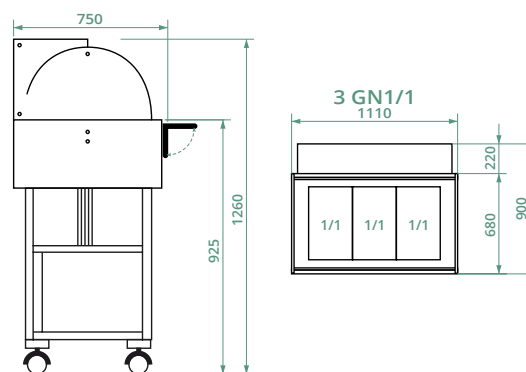

**IT** Carrelli termici a bagnomaria in legno, con cupola. Struttura in legno multistrato di betulla - cupola semicircolare in plexiglass - riscaldato con resistenza elettrica - disponibili con 1 mensola ripieghevole e 1 piano di appoggio - ruote  $\varnothing$  75 mm di cui due con freno. Bacinelle escluse - le temperature di lavoro indicate sono da considerarsi con coperchi posizionati.

**EN** Wooden heated bain-marie trolleys with dome. Multi-layered birch wood structure - half-round Plexiglas dome - electric heating element - available with 1 foldable shelf and 1 support base -  $\varnothing$  75 mm wheels, two of which with brakes. Containers not included - the operating temperatures listed are to be considered with lids on.

**FR** Chariots bain-marie chauffants en bois avec clochette. Structure en multicouche de bouleau - clochette en plexiglas semi-circulaire - chauffé par résistance électrique - disponibles avec 1 étagère escamotable et 1 plan de travail - roues de  $\varnothing$  75 mm, dont deux avec freins. Bacs non compris - les températures de travail indiquées sont à considérer avec couvercles en place.

**DE** Bain-Marie Heizwagen aus Holz mit Haube. Birkensperrholzstruktur - halbrunde Plexiglashaube - mit elektrischem Heizstab beheizt - mit 1 Faltfläche und 1 Ablagefläche - räder  $\varnothing$  75 mm, davon zwei mit Bremsen. Behälter nicht enthalten - die angegebenen Arbeitstemperaturen sind bei aufgesetzten Deckeln zu verstehen.

	CL				
	2778N noce-walnut	2778NW wengé	2778NCA carbon	2778NCE cenere-ash gray	2778NB laccato bianco laquered white
	2000 W				
	230V/1N/50 Hz				
	+30°C +90°C				
	3x GN1/1 - Max 150(h) mm				
	2.700 €				2.865 €

# CL2774N



CL2774NCA

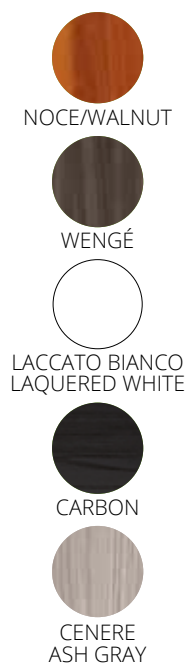
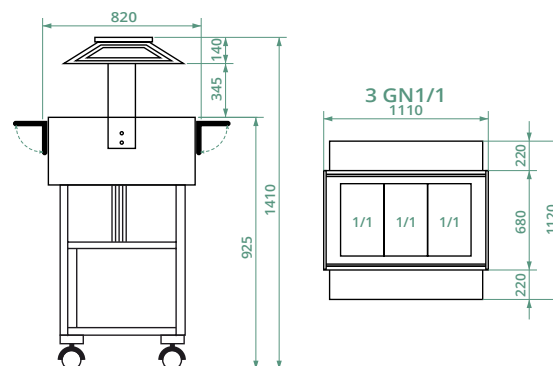

IT Carrelli termici a bagnomaria in legno, da buffet. Struttura in legno multistrato di betulla - cupola in plexiglass - luce al neon - riscaldato con resistenza elettrica - disponibili con 2 mensole ripieghevoli - ruote  $\varnothing$  75 mm di cui due con freno. Bacinelle escluse - le temperature di lavoro indicate sono da considerarsi con coperchi posizionati.

EN Wooden heated bain-marie trolleys, for buffet. Multi-layered birch wood structure - half-round Plexiglas dome - neon light - electric heating element - available with two foldable shelves -  $\varnothing$  75 mm wheels, two of which with brakes. Containers not included - the operating temperatures listed are to be considered with lids on.

FR Chariots bain-marie chauffants en bois, pour buffet. Structure en multicouche de bouleau - clochette en plexiglas - lampe néon - chauffé par résistance électrique - disponibles avec 2 étagères escamotables - roues de  $\varnothing$  75 mm, dont deux avec freins. Bacs non compris - les températures de travail indiquées sont à considérer avec couvercles en place.

DE Bain-Marie Heizwagen aus Holz für Buffets. Birkensperholzstruktur - Plexiglashaube - Neonlampe - mit elektrischem Heizstab beheizt - mit 2 Faltflächen - räder  $\varnothing$  75 mm, davon zwei mit Bremsen. Behälter nicht enthalten - die angegebenen Arbeitstemperaturen sind bei aufgesetzten Deckeln zu verstehen.

	CL				
	2774N noce-walnut	2774NW wengé	2774NCA carbon	2774NCE cenere-ash gray	2774NB laccato bianco laquered white
	2000 W				
	230V/1N/50 Hz				
	+30°C +90°C				
	3x GN1/1 - Max 150(h) mm				
	2.915 €				3.050 €

OPTIONAL



# ELC2832



ELC2832CE

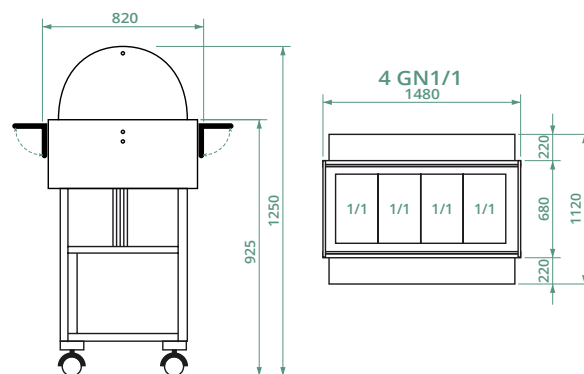

**IT** Espositore termico a bagnomaria in legno, con cupola. Struttura in legno multistrato di betulla - cupola semicircolare in plexiglass - riscaldato con resistenza elettrica - disponibili con 2 mensole ripieghevoli - ruote  $\varnothing$  75 mm di cui due con freno. Bacinelle escluse - le temperature di lavoro indicate sono da considerarsi con coperchi posizionati.

**EN** Wooden heated bain-marie display with dome. Multi-layered birch wood structure - half-round Plexiglas dome - electric heating element - available with two foldable shelves -  $\varnothing$  75 mm wheels, two of which with brakes. Containers not included - the operating temperatures listed are to be considered with lids on.

**FR** Présentoir bain-marie chauffants en bois avec clochette. Structure en multicouche de bouleau - clochette en plexiglas semi-circulaire - chauffé par résistance électrique - disponibles avec 2 étagères escamotables - roues de  $\varnothing$  75 mm, dont deux avec freins. Bacs non compris - les températures de travail indiquées sont à considérer avec couvercles en place.

**DE** Bain-Marie Heizvitrine aus Holz mit Haube. Birkensperholzstruktur - halbrunde Plexiglashaube - mit elektrischem Heizstab beheizt - mit 2 Faltflächen - räder  $\varnothing$  75 mm, davon zwei mit Bremsen. Behälter nicht enthalten - die angegebenen Arbeitstemperaturen sind bei aufgesetzten Deckeln zu verstehen.

	ELC				
	2832 noce-walnut	2832W wengé	2832CA carbon	2832CE cenere-ash gray	2832B laccato bianco laquered white
	2000 W				
	230V/1N/50 Hz				
	+30°C +90°C				
	4x GN1/1 - Max 150(h) mm				
	2.940 €				3.125 €

# ELC2834



ELC2834B

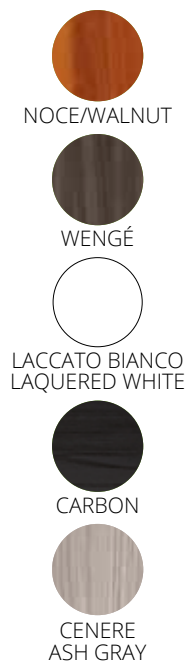
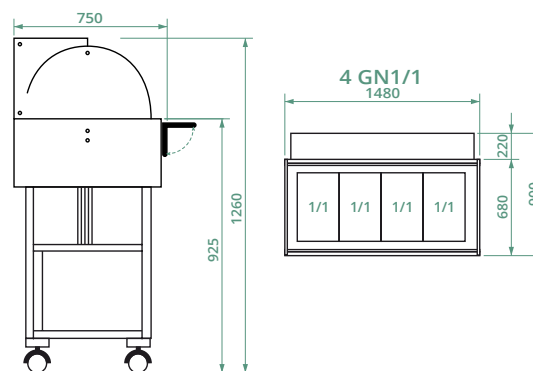

**IT** Espositore termico a bagnomaria in legno, con cupola. Struttura in legno multistrato di betulla - cupola semicircolare in plexiglass - riscaldato con resistenza elettrica - disponibili con 1 mensola ripieghevole e 1 piano di appoggio - ruote  $\varnothing$  75 mm di cui due con freno. Bacinelle escluse - le temperature di lavoro indicate sono da considerarsi con coperchi posizionati.

**EN** Wooden heated bain-marie display with dome. Multi-layered birch wood structure - half-round Plexiglas dome - electric heating element - available with 1 foldable shelf and 1 support base -  $\varnothing$  75 mm wheels, two of which with brakes. Containers not included - the operating temperatures listed are to be considered with lids on.

**FR** Présentoir bain-marie chauffants en bois avec clochette. Structure en multicouche de bouleau - clochette en plexiglas semi-circulaire - chauffé par résistance électrique - disponibles avec 1 étagère escamotable et 1 plan de travail - roues de  $\varnothing$  75 mm, dont deux avec freins. Bacs non compris - les températures de travail indiquées sont à considérer avec couvercles en place.

**DE** Bain-Marie Heizvitrine aus Holz mit Haube. Birkensperholzstruktur - halbrunde Plexiglashaube - mit elektrischem Heizstab beheizt - mit 1 Faltfläche und 1 Ablagefläche - räder  $\varnothing$  75 mm, davon zwei mit Bremsen. Behälter nicht enthalten - die angegebenen Arbeitstemperaturen sind bei aufgesetzten Deckeln zu verstehen.

i	ELC				
	2834 noce-walnut	2834W wengé	2834CA carbon	2834CE cenere-ash gray	2834B laccato bianco laquered white
⚡	2000 W				
1 Ph	230V/1N/50 Hz				
🌡️	+30°C +90°C				
🍽️	4x GN1/1 - Max 150(h) mm				
	2.980 €				3.190 €

OPTIONAL



# ELC2828



ELC2828

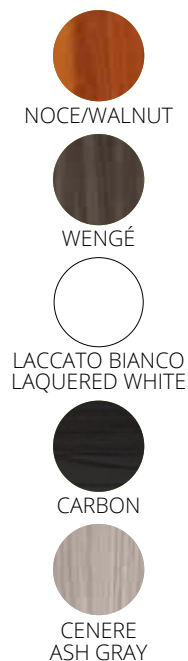
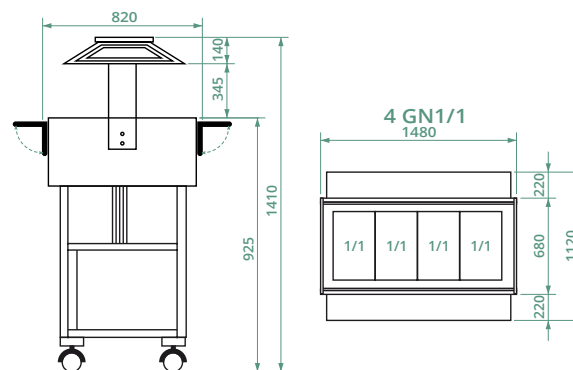

**IT** Espositore termico a bagnomaria in legno. Struttura in legno multistrato di betulla - cupola in plexiglass - luce al neon - riscaldato con resistenza elettrica - disponibili con 2 mensole ripieghevoli - ruote  $\varnothing$  75 mm di cui due con freno. Bacinelle escluse - le temperature di lavoro indicate sono da considerarsi con coperchi posizionati.

**EN** Wooden heated bain-marie display. Multi-layered birch wood structure - half-round Plexiglas dome - neon light - electric heating element - available with two foldable shelves -  $\varnothing$  75 mm wheels, two of which with brakes. Containers not included - the operating temperatures listed are to be considered with lids on.

**FR** Présentoir bain-marie chauffants en bois. Structure en multicouche de bouleau - clochette en plexiglas - lampe néon - chauffé par résistance électrique - disponibles avec 2 étagères escamotables - roues de  $\varnothing$  75 mm, dont deux avec freins. Bacs non compris - les températures de travail indiquées sont à considérer avec couvercles en place.

**DE** Bain-Marie Heizvitrine aus Holz. Birkensperholzstruktur - Plexiglashaube - Neonlampe - mit elektrischem Heizstab beheizt - mit 2 Faltflächen - räder  $\varnothing$  75 mm, davon zwei mit Bremsen. Behälter nicht enthalten - die angegebenen Arbeitstemperaturen sind bei aufgesetzten Deckeln zu verstehen.

	ELC				
	2828 noce-walnut	2828W wengé	2828CA carbon	2828CE cenere-ash gray	2828B laccato bianco laquered white
	2000 W				
	230V/1N/50 Hz				
	+30°C +90°C				
	4x GN1/1 - Max 150(h) mm				
	3.170 €				3.360 €

# CL2770N



**IT** Carrello termico in legno, ideale per bolliti e arrostiti. Struttura portante in legno multistrato di betulla - vasca in acciaio inox AISI 304 munita di scarico. Ruote ø 75 mm di cui due con freno. Bacinelle escluse. Immagine con optional A580 - A590 - A600.

**EN** Wooden heated trolley, ideal for boiled and roasted meats. Multi-layered birch wood structure - stainless steel AISI 304 bowl with drain. ø 75 mm wheels, two of which with brakes. Containers not included. Image with optional A580 - A590 - A600.

OPTIONAL  
SOLO PER MOD. / ONLY FOR CL2770N

A580	A590
Portacoperchi inox Stainless steel lid holder Porte-couvercle en acier inox Edelstahl-Deckelhalter	Portacoltelli Knives holder Porte-couteaux Messerhalter
100 €	65 €
A600	
Scorrevole portapiatti con tagliere polietilene Sliding plate holder with polyethylene chopping board Porte-plat coulissant avec planche en polyéthylène Gleitplattenhalter mit Polyethylen-Schneidebrett	
155 €	

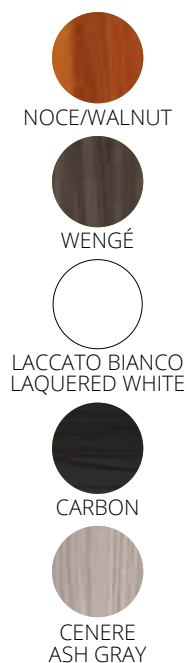

**FR** Chariot chauffant en bois, idéal pour les viandes bouillies et rôties. Structure portante en multicouche de bouleau - cuve en acier inox AISI 304 avec vidange. Roues de ø 75 mm, dont deux avec freins. Bacs non compris. Photo avec optional A580 - A590 - A600.

**DE** Heizwagen aus Holz, ideal für gekochtes und gebratenes Fleisch. Birkenperrholztragstruktur - Becken aus Edelstahl AISI 304 mit Ablauf. Räder ø 75 mm, davon zwei mit Bremsen. Behälter nicht enthalten. Bild mit optional A580 - A590 - A600.

i	CL				
	2770N noce-walnut	2770NW wengé	2770NCA carbon	2770NCE cenere-ash gray	2770NB laccato bianco laquered white
⚡	2000 W				
1 Ph	230V/1N/50 Hz				
🌡️	+30°C +90°C				
🍲	3x GN1/1 - Max 150(h) mm				
↗️ cm	123 x 65 x 95(h) cm				
	2.080 €			2.220 €	

Carrello termico, ideale per bolliti e arrostiti  
Heated trolley, ideal for boiled and roasted meats

# OPTIONAL

CLR311
Vasca inox forata - Stainless steel perforated container Bac inox perforée - Behälter aus rostfreiem - Stahl mit löcher
CLR2788N - CLR2787N - CLR2786N
3x GN1/1 - 100(h) mm
210 €

CF411
Vasca inox forata - Stainless steel perforated container Bac inox perforée - Behälter aus rostfreiem - Stahl mit löcher
ELR2827 - ELR2826 - ELR2825
4x GN1/1 - 100(h) mm
250 €

## MLUN



## ANUN

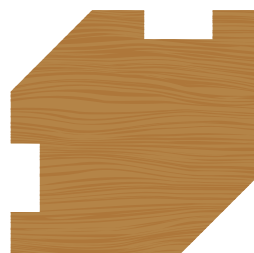

PER MODELLI / FOR MODEL			
CLR2786N CLR2787N CLR2788N	ELR2825 ELR2826 ELR2827	ELC2828 ELC2832 ELC2834	CL2774N CL2777N CL2778N

## MLUNW



## ANUNW



	MLUN noce-walnut	MLUNW wengé	ANUN noce-walnut	ANUNW wengé
	Mensole in legno per unione - Connection wooden shelf Étagères en bois pour raccords - Verbindungsregale aus Holz			
 cm	68 x 70 cm		88 x 88 cm	
	170 €		210 €	

# OPTIONAL

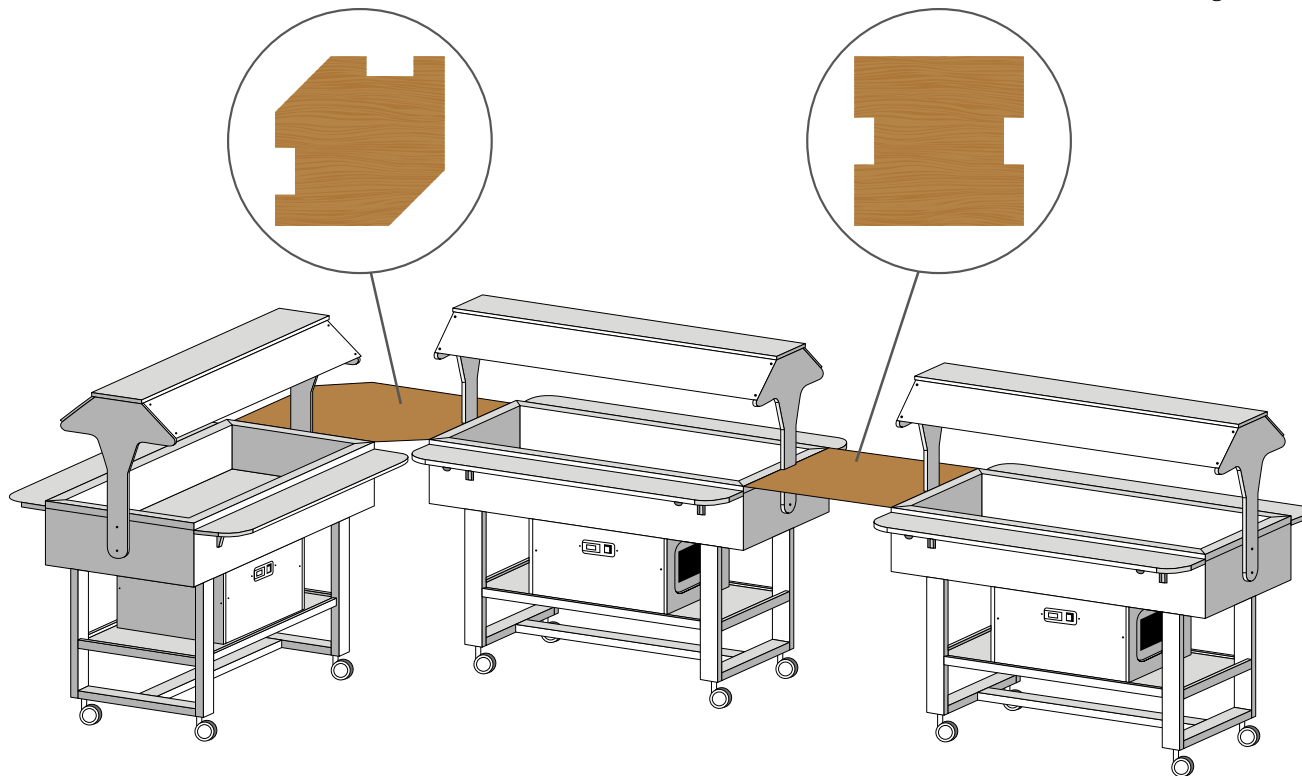
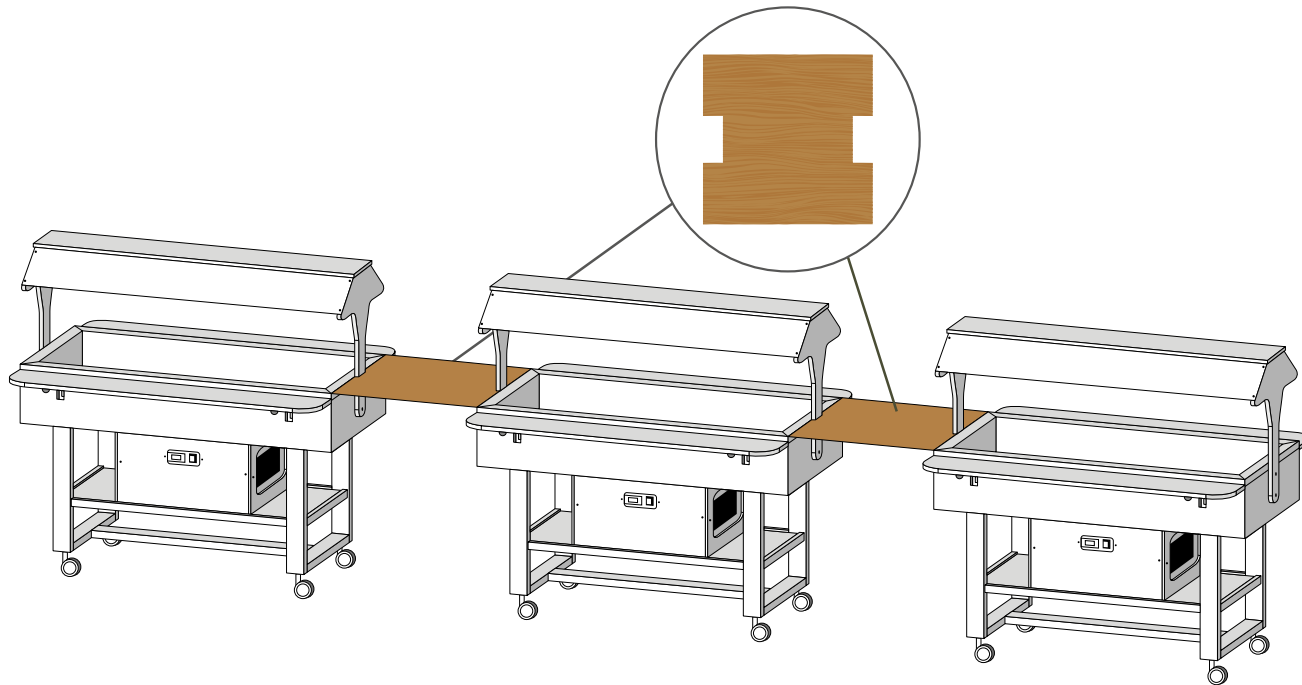



# Carrelli, vasche e distributori in acciaio inox

STAINLESS STEEL TROLLEYS,  
BOWLS AND DISPENSERS.  
CHARIOTS, CUVES ET  
DISTRIBUTEURS EN ACIER INOX  
WAGEN, WANNEN UND  
SPENDER AUS EDELSTAHL

# G-VRI211 - G-VRI311 - G-VRI411 G-VRI311F - G-VRI411F

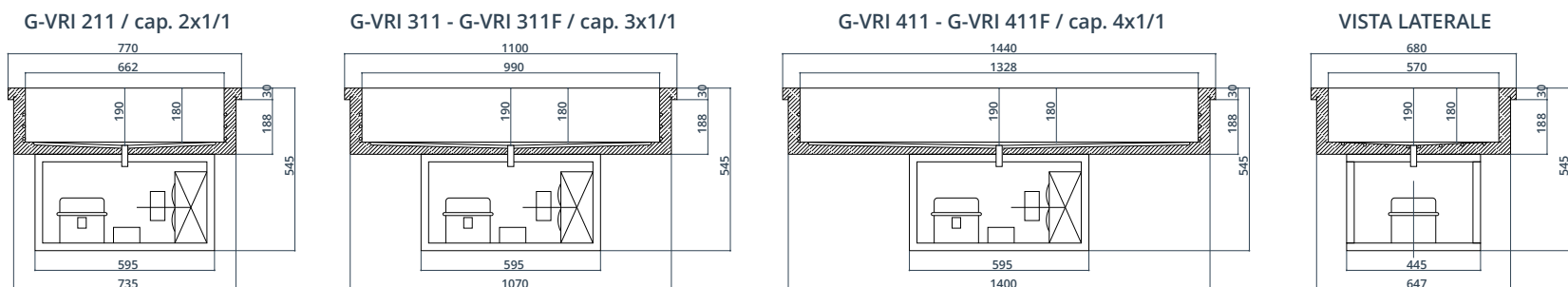

G-VRI311



	G-VRI211	G-VRI311	G-VRI411	G-VRI311F	G-VRI411F
	340 W				
	230V/1N/50 Hz				
	R290				
	+2°C +8°C			-5°C +5°C	
	2x GN1/1 Max 150(h) mm	3x GN1/1 Max 150(h) mm	4x GN1/1 Max 150(h) mm	3x GN1/1 Max 150(h) mm	4x GN1/1 Max 150(h) mm
	1.300 €	1.375 €	1.470 €	1.690 €	1.820 €

**IT** Vasche refrigerate da incasso in acciaio inox AISI 304. Struttura in acciaio inox AISI 304 - spessore isolamenti 50 mm - refrigerazione statica - gruppo incorporato nel vano inferiore - controllo temperatura elettronico con termostato digitale - sbrinamento automatico - evaporazione dell'acqua di condensa automatica.

**EN** Stainless steel AISI 304 refrigerated bowls. Stainless steel AISI 304 structure - 50 mm insulation thickness - static refrigeration - built-in control unit in the lower compartment - electronic temperature control with digital thermostat - automatic defrosting - automatic evaporation of condensation water.

**FR** Cuves réfrigérées en acier inox AISI 304. Structure en acier inox AISI 304 - épaisseur d'isolation de 50 mm - réfrigération statique - unité incorporée dans le compartiment inférieur - régulation électronique de température avec thermostat digital - dégivrage automatique - évaporation automatique de l'eau de condensation.

**DE** Kühlwannen aus Edelstahl AISI 304. Struktur aus Edelstahl AISI 304 - 50 mm Isolierstärke - statische Kühlung - Einbaueinheit im unteren Fach - elektronische Temperaturregelung mit digitalem Thermostat - automatische Abtauung - automatische Kondensatverdampfung.

Vasche refrigerate in acciaio inox AISI 304 ad incasso  
Recessed stainless steel AISI 304 refrigerated bowls

# VBC211 - VBC311 - VBC411



VBC311

VBC 211 - cap. 2x1/1

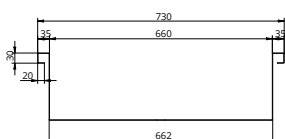

VBC 311 - cap. 3x1/1

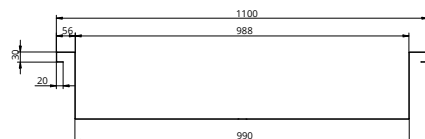

VBC 411 - cap. 4x1/1

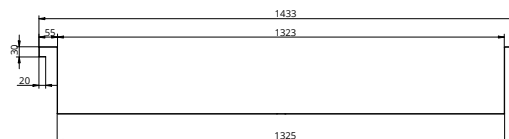

VISTA LATERALE

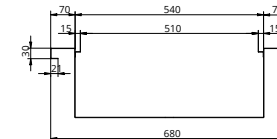

**IT** Vasche termiche da incasso a bagnomaria in acciaio inox AISI 304. Vasca dotata di scarico acqua - controllo temperatura elettronico con termostato digitale.

**FR** Cuves bain-marie en acier inox AISI 304. Cuve équipée de vidange d'eau - régulation électronique de la température avec thermostat digital.

**EN** Stainless steel AISI 304 heated Bain-marie bowls. Bowl with water drain - electronic temperature control with digital thermostat.

**DE** Bain-Marie Heizwannen aus Edelstahl AISI 304. Wanne mit Wasserablauf - elektronische Temperaturregelung mit digitalem Thermostat.

	VBC211	VBC311	VBC411	CLR311	CF411
	2000 W			Griglia forata 3x GN1/1 S/S perforated container 3x GN1/1	Vasca inox forata 4x GN1/1 S/S perforated container 4x GN1/1
	230V/1N/50 Hz				
	+30°C +90°C				
	2x GN1/1 - Max 150(h) mm	3x GN1/1 - Max 150(h) mm	4x GN1/1 - Max 150(h) mm		
	745 €	825 €	970 €	210 €	250 €

# CAR2779



CAR2779

# CAR2780 CAR2780BT









CAR2780

**IT** Carrelli refrigerati in acciaio inox. Struttura in acciaio inox AISI 304 - refrigerazione statica - maniglia direzionale - ruote multidirezionali  $\varnothing$  125 mm. Bacinelle escluse - le temperature di lavoro indicate sono da considerarsi con coperchi posizionati.

**EN** Stainless steel refrigerated trolleys. Stainless steel AISI 304 structure - static refrigeration - directional handle - multidirectional wheels  $\varnothing$  125 mm. Containers not included - the operating temperatures listed are to be considered with lids on.

**FR** Chariots réfrigéré en acier inox. Structure en acier inox AISI 304 - réfrigération statique - poignée directionnelle - roues multidirectionnelles  $\varnothing$  125 mm. Bacs non compris - les températures de travail indiquées sont à considérer avec couvercles en place.

**DE** Kühlwagen aus Edelstahl. Struktur Edelstahl AISI 304 - statische Kühlung - Lenkgriff - Mehrwegräder  $\varnothing$  125 mm. Behälter nicht enthalten - die angegebenen Arbeitstemperaturen sind bei aufgesetzten Deckeln zu verstehen.

	CAR2779	CAR2780	CAR2780BT
	250 W		
 1 Ph	230V/1N/50 Hz		
	R600a		
	+2°C +10°C		-5°C +5°C
	3x GN1/1 - Max 150(h) mm		
 cm	124 x 72 x 94(h) cm	124 x 72 x 126(h) cm	
	2.300 €	2.750 €	3.100 €

Carrelli refrigerati in acciaio inox AISI 304  
Stainless steel AISI 304 refrigerated trolleys

# CT1760C



CT1760C

**IT** Carrello termico a bagnomaria. Struttura in acciaio inox AISI 304 - vasca a doppia parete provvista di rubinetto di scarico posto sul fondo - termostato regolabile - maniglia direzionale - paracolpi - ruote multidirezionali  $\varnothing$  125 mm. Bacinelle escluse - le temperature di lavoro indicate sono da considerarsi con coperchi posizionati.

**FR** Chariot chauffantes bain-marie. Structure en acier inox AISI 304 - cuve à double paroi équipée d'un robinet de vidange en bas - thermostat réglable - poignée directionnelle - butoirs - roues multidirectionnelles  $\varnothing$  125 mm. Bacs non compris - les températures de travail indiquées sont à considérer avec couvercles en place.

**EN** Bain-marie heated trolley. Stainless steel AISI 304 structure - double walled bowl with drain valve fitted at the bottom - adjustable thermostat - directional handle - shock absorber - multidirectional wheels  $\varnothing$  125 mm. Containers not included - the operating temperatures listed are to be considered with lids on.

**DE** Bain-Marie Heizwagen Struktur aus Edelstahl AISI 304 - Doppelwandige Wanne mit einem Ablaufhahn im Unterteil - einstellbarer Thermostat - Lenkergriff - Stoßschutz - Mehrwegräder  $\varnothing$  125 mm. Behälter nicht enthalten - die angegebenen Arbeitstemperaturen sind bei aufgesetzten Deckeln zu verstehen.

	CT1760C
	2000 W
	230V/1N/50-60 Hz
	+30°C +90°C
	3x GN1/1 - Max 200(h) mm
	117 x 67 x 114(h) cm
	1.600 €

# CT1758TD CT1760TD



CT1760TD

**IT** Carrelli termici a bagnomaria con temperature differenziate in acciaio inox AISI 304. Struttura in acciaio inox AISI 304 - vasca a doppia parete provvista di rubinetto di scarico posto sul fondo - termostato regolabile - maniglia direzionale - paracolpi - ruote multidirezionali ø 125 mm. Bacinelle escluse - le temperature di lavoro indicate sono da considerarsi con coperchi posizionati.

**FR** Chariots chauffants bain-marie à températures différenciées en acier inox AISI 304. Structure en acier inox AISI 304 - cuve à double paroi équipée d'un robinet de vidange en bas - thermostat réglable - poignée directionnelle - butoirs - roues multidirectionnelles ø 125 mm. Bacs non compris - les températures de travail indiquées sont à considérer avec couvercles en place.

**EN** Stainless steel AISI 304 Bain-marie heated trolleys with separate temperatures. Stainless steel AISI 304 structure - double walled bowl with drain valve fitted at the bottom - adjustable thermostat - directional handle - shock absorber - multidirectional wheels ø 125 mm. Containers not included - the operating temperatures listed are to be considered with lids on.

**DE** Bain-Marie Heizwagen mit unterschiedlichen Temperaturen aus Edelstahl AISI 304. Struktur aus Edelstahl AISI 304 - Doppelwandige Wanne ausgestattet mit einem unten angebrachten Ablaufventil - einstellbarer Thermostat - Lenkergriff - Stoßschutz - Mehrwegräder ø 125 mm. Behälter nicht enthalten - die angegebenen Arbeitstemperaturen sind bei aufgesetzten Deckeln zu verstehen.

	CT1758TD	CT1760TD
	2000 W	3000 W
	230V/1N/50-60 Hz	
	+30°C +90°C	
	2x GN1/1 - Max 150(h) mm	3x GN1/1 - Max 150(h) mm
	84 x 65 x 85(h) cm	117 x 67 x 85(h) cm
	1.050 €	1.310 €

Con temperature differenziate  
With separate temperatures

# CT1765

# CT1770









CT1765



CT1770

**IT** Carrelli termici a bagnomaria armadiati. Struttura in acciaio inox AISI 304 - vano superiore in doppia parete coibentata - coperchi apribili a compasso fino a 180° per formare un piano di appoggio - provvisti di rubinetto di scarico posto sul fondo - temperatura differenziata solo per modelli CT1765TD - CT1770TD - 2 ruote fisse e 2 multidirezionali con freno da Ø 140 mm. Bacinelle escluse - le temperature di lavoro indicate sono da considerarsi con coperchi posizionati.

**EN** Bain-marie heated trolleys on counters. Structure in AISI 304 stainless steel - insulated double-walled upper compartment - lids that can be opened up to 180° to form a support surface. Equipped with a drain valve on the bottom - differentiated temperature for mod CT1765TD - CT1770TD - 2 fixed wheels and 2 multidirectional wheels Ø 140 mm with brakes. Containers not included - the operating temperatures listed are to be considered with lids on.

	CT1765	CT1770	A650	A700
	2000 W		mod. CT1765	mod. CT1770
 1 Ph	230V/1N/50-60 Hz		Vano inferiore riscaldato Heated lower compartment Compartiment inferieur chauffé Beheiztes Unterfach	
	+30°C +90°C			
	2x GN1/1 - Max 200(h) mm	3x GN1/1 - Max 200(h) mm		
 cm	96 x 68 x 102(h) cm	130 x 68 x 102(h) cm		
	2.720 €	3.350 €	270 €	

# CT1765TD





CT1765TD

# CT1770TD



FR Chariots chauffantes bain-marie sur meublé fermé. Structure en acier inox AISI 304 - compartiment supérieur en double paroi isolée - couvercles pouvant s'ouvrir jusqu'à 180° pour former une surface d'appui - température différenciée pour CT1765TD - CT1770TD - 2 roues fixes et 2 roues multidirectionnelles ø 140 mm, avec freins, équipées d'un robinet de vidange placé en bas. Bacs non compris - les températures de travail indiquées sont à considérer avec couvercles en place.

DE Bain-Marie Heizwagen mit Schrankelement. Struktur aus Edelstahl AISI 304 - oberes Fach mit isoliertem Doppelwand - Deckel bis zu 180° öffnungsfähig, um eine Auflagefläche zu bilden, ausgestattet mit einem unten angebrachten Ablaufventil - unterschiedlichen Temperaturen mod. CT1765TD - CT1770TD - 2 feste Räder und 2 Mehrwegräder ø 140 mm mit Bremsen. Behälter nicht enthalten - die angegebenen Arbeitstemperaturen sind bei aufgesetzten Deckeln zu verstehen.

	CT1765TD	CT1770TD	A650	A700
	2000 W	3000 W	mod. CT1765TD	mod. CT1770TD
	230V/1N/50-60 Hz		Vano inferiore riscaldato Heated lower compartment Compartiment inferieur chauffé Beheiztes Unterfach	
	+30°C +90°C			
	2x GN1/1 - Max 150(h) mm	3x GN1/1 - Max 150(h) mm		
	96 x 68 x 102(h) cm	130 x 68 x 102(h) cm		
	2.850 €	3.640 €	270 €	

Con temperature differenziate  
With separate temperatures







# CT1766 - CT1771



CT1771

**IT** Carrelli termici a bagnomaria armadiati. Struttura in acciaio inox AISI 304 - vano superiore in doppia parete coibentata - provvisti di rubinetto di scarico posto sul fondo - temperatura differenziata solo per modelli CT1766TD - CT1771TD - 2 ruote fisse e 2 multidirezionali con freno  $\varnothing$  140 mm. Bacinelle escluse.

**EN** Bain-marie heated trolleys on counters. Structure in AISI 304 stainless steel - insulated double-walled upper compartment - equipped with a drain valve on the bottom - differentiated temperature for mod CT1766TD - CT1771TD - 2 fixed wheels and 2 multidirectional wheels  $\varnothing$  140 mm with brakes. Containers not included.

	CT1766	CT1771	A650	A700
	2000 W		mod. CT1766	mod. CT1771
 1 Ph	230V/1N/50-60 Hz		Vano inferiore riscaldato Heated lower compartment Compartiment inferieur chauffé Beheiztes Unterfach	
	+30°C +90°C			
	2x GN1/1 - Max 200(h) mm	3x GN1/1 - Max 200(h) mm		
 cm	96 x 68 x 92(h) cm	130 x 68 x 92(h) cm		
	2.160 €	2.770 €	270 €	

# CT1766TD - CT1771TD



CT1771TD

FR Bain-marie heated trolleys on counters with differentiated temperature. Structure in AISI 304 stainless steel - insulated double-walled upper compartment - équipée d'un robinet de vidange en bas - température différenciée pour CT1766TD - CT1771TD - 2 roues fixes et 2 roues multidirectionnelles ø 140 mm, avec freins. Bacs non compris.

DE Bain-Marie Heizwagen mit Schrankelement mit unterschiedlichen Temperaturen. Struktur aus Edelstahl AISI 304 - oberes Fach in isolierter Doppelwand - ausgestattet mit einem unten angebrachten Ablaufventil - unterschiedlichen Temperaturen mod. CT1766TD - CT1771TD - 2 feste Räder und 2 Mehrwegräder ø 140 mm mit Bremsen. Behälter nicht enthalten.

	CT1766TD	CT1771TD	A650	A700
	2000 W	3000 W	mod. CT1766TD	mod. CT1771TD
	230V/1N/50-60 Hz		Vano inferiore riscaldato Heated lower compartment Compartiment inferieur chauffé Beheiztes Unterfach	
	+30°C +90°C			
	2x GN1/1 - Max 150(h) mm	3x GN1/1 - Max 150(h) mm		
	96 x 68 x 92(h) cm	130 x 68 x 92(h) cm		
	2.385 €	3.060 €	270 €	

Con temperature differenziate  
With separate temperatures

# CT1756 - CT1758 - CT1760 - CT1762



CT1760

IT Carrelli termici. Struttura in acciaio inox AISI 304 - vasca a doppia parete - termostato regolabile - maniglia direzionale - rubinetto di scarico - ruote multidirezionali ø 125 mm. Bacinelle escluse - le temperature di lavoro indicate sono da considerarsi con coperchi posizionati.

EN Heated trolleys. Stainless steel AISI 304 structure - double walled bowl - adjustable thermostat - directional handle - drain valve - multidirectional wheels ø 125 mm. Containers not included - the operating temperatures listed are to be considered with lids on.

A BAGNOMARIA / BAIN MARIE				
	CT1756	CT1758	CT1760	CT1762
	2000 W			
	230V/1N/50-60 Hz			
	+30°C +90°C			
	1x GN1/1 - Max 200(h) mm	2x GN1/1 - Max 200(h) mm	3x GN1/1 - Max 200(h) mm	4x GN1/1 - Max 200(h) mm
	56 x 65 x 85(h) cm	84 x 65 x 85(h) cm	117 x 65 x 85(h) cm	148 x 65 x 85(h) cm
	900 €	1.050 €	1.200 €	1.350 €



Carrelli termici in acciaio inox AISI 304  
Stainless steel AISI 304 heated trolley

forcar®

# CTS1757 - CTS1759 - CTS1761



CTS1759

FR Chariots chauffants. Structure en acier inox AISI 304 - cuve à double paroi - thermostat réglable - poignée directionnelle - robinet de vidange - roues multidirectionnelles ø 125 mm. Bacs non compris - les températures de travail indiquées sont à considérer avec couvercles en place.

DE Heizwagen. Struktur aus Edelstahl AISI 304 - Doppelwandige Wanne - einstellbarer Thermostat - Lenkergriff - Ablaufventil - Mehrwegräder ø 125 mm. Behälter nicht enthalten - die angegebenen Arbeitstemperaturen sind bei aufgesetzten Deckeln zu verstehen.

CON RESISTENZA A SECCO / WITH DRY HEATING ELEMENT			
	CTS1757	CTS1759	CTS1761
	1000 W		2000 W
	230V/1N/50-60 Hz		
	+30°C +90°C		
	1x GN1/1 - Max 200(h) mm	2x GN1/1 - Max 200(h) mm	3x GN1/1 - Max 200(h) mm
	56 x 65 x 85(h) cm	84 x 65 x 85(h) cm	117 x 65 x 85(h) cm
	785 €	925 €	1.080 €



# Elementi riscaldanti e vetrine neutre

HEATING ELEMENTS  
AND NEUTRAL DISPLAYS  
ÉLÉMENTS CHAUFFANTS  
ET VITRINES NEUTRES  
HEIZELEMENTE UND NEUTRALE VITRINEN

BM1780 - BM1782  
BM1784 - BM1786

BMS1781 - BMS1783  
BMS1785



BM1784



BMS1785

IT Tavole calde. Struttura in acciaio inox AISI 304 - parete coibentata - rubinetto di scarico - termostato regolabile. Le bacinelle sono escluse.

FR Tables chaudes. Structure en acier inox AISI 304 - paroi isolée - robinet de vidange - thermostat réglable. Les bacs ne sont pas compris.

EN Heated tables. Stainless steel AISI 304 structure - insulated wall - drain valve - adjustable thermostat. Containers not included.

DE Heitzische. Struktur aus Edelstahl AISI 304 - isolierte Wand - Ablaufventil - einstellbarer Thermostat. Behälter nicht enthalten.

	A BAGNOMARIA / BAIN MARIE				CON RESISTENZA A SECCO / WITH DRY HEATING ELEMENT		
	BM1780	BM1782	BM1784	BM1786	BMS1781	BMS1783	BMS1785
	2000 W				1000 W		
	230V/1N/50-60 Hz						
	+30°C +90°C						
	1x GN1/1 Max 200(h) mm	2x GN1/1 Max 200(h) mm	3x GN1/1 Max 200(h) mm	4x GN1/1 Max 200(h) mm	1x GN1/1 Max 200(h) mm	2x GN1/1 Max 200(h) mm	3x GN1/1 Max 200(h) mm
	49 x 60 x 32(h) cm	78 x 60 x 32(h) cm	110 x 60 x 32(h) cm	144 x 60 x 32(h) cm	49 x 60 x 32(h) cm	78 x 60 x 32(h) cm	110 x 60 x 32(h) cm
	750 €	880 €	1.000 €	1.170 €	550 €	690 €	850 €

Tavole calde  
Heated tables

## BM11 - BM21 - BM31



BM11

IT Tavole calde a bagnomaria. Struttura in acciaio inox AISI 304 - termostato regolabile. Le bacinelle sono escluse.

EN Bain-marie heated tables. Stainless steel AISI 304 structure - adjustable thermostat. Containers not included.

FR Tables chaudes avec bain-marie. Structure en acier inox AISI 304 - thermostat réglable. Les bacs ne sont pas compris.

DE Bain-Marie Heitzische. Struktur aus Edelstahl AISI 304 - einstellbarer Thermostat. Behälter nicht enthalten.

## BMV11 - BMV21 BMV31





BMV21







IT Tavole calde a bagnomaria. Struttura in acciaio inox AISI 304 - rubinetto di scarico - temperature vasche differenziate - termostato regolabile. Le bacinelle sono escluse.

EN Bain-marie heated tables. Stainless steel AISI 304 structure - drain valve - differentiated bowl temperatures - adjustable thermostat. Containers not included.

FR Tables chaudes avec bain-marie. Structure en acier inox AISI 304 - robinet de vidange - différentes températures des cuves - thermostat réglable. Les bacs ne sont pas compris.

DE Bain-Marie Heitzische. Struktur aus Edelstahl AISI 304 - Ablaufventil - unterschiedliche Temperaturen - einstellbarer Thermostat. Behälter nicht enthalten.

	BM11	BM21	BM31
	1200 W	1200 + 1200 W	1000 + 1000 + 1000 W
 1 Ph	230V/1N/50-60 Hz		
	+30°C +90°C		
	1x GN1/1 Max 150(h) mm	2x GN1/1 Max 150(h) mm	3x GN1/1 Max 150(h) mm
	54 x 33 x 22(h) cm	66 x 54 x 22(h) cm	99 x 54 x 22(h) cm
	340 €	465 €	630 €

	BMV11	BMV21	BMV31
	1200 W	1200 + 1200 W	1000 + 1000 + 1000 W
 1 Ph	230V/1N/50-60 Hz		
	+30°C +90°C		
	1x GN1/1 Max 150(h) mm	2x GN1/1 Max 150(h) mm	3x GN1/1 Max 150(h) mm
	54 x 33 x 22(h) cm	66 x 54 x 22(h) cm	99 x 54 x 22(h) cm
	385 €	560 €	775 €

# BM7700



BM7700

IT Tavola calda a bagnomaria. Struttura in acciaio inox - bacinella esclusa.

EN Bain-marie heated table. Stainless steel structure - containers not included.

FR Table chaude avec bain-marie. Structure en acier inox - bacs pas compris.

DE Bain-Marie Heitzisch. Edelstahlstruktur - Behälter nicht enthalten.

# BMP7720









BMP7720







IT Tavola calda a bagnomaria. Struttura in acciaio inox - modello compreso di 2 pentole da 8 L.

EN Bain-marie heated table. Stainless steel structure - with 2 pans of 8 L.

FR Table chaude avec bain-marie. Structure en acier inox - modèle équipé de 2 marmites de 8 L.

DE Bain-Marie Heitzisch. Struktur aus Edelstahl - Modell mit 2 Kesseln 8 L je.

	BM7700
	1200 W
 1 Ph	230V/1N/50-60 Hz
	+30°C +90°C
	1x GN1/1 - Max 150(h) mm
 cm	57 x 37 x 22(h) cm
	<b>200 €</b>

	BMP7720
	1200 W
 1 Ph	230V/1N/50-60 Hz
	+30°C +90°C
	2 pentole incluse / 2 pots included
 cm	57 x 37 x 28(h) cm
	<b>280 €</b>

PC4750 - PC4752  
 PC4754 - PC5050  
 PC6040 - PC8060

PVC4760  
 PVC4763  
 PVC4765



PC4754

PVC4760

- IT Piani caldi in acciaio inox. Struttura in acciaio inox AISI 304 - termostato regolabile.
- EN Hot plates in stainless steel. Stainless steel AISI 304 structure - adjustable thermostat.
- FR Plaques chauffantes en acier inox. Structure en acier inox AISI 304 - thermostat réglable.
- DE Heiße Edelstahlplatten. Struktur aus Edelstahl AISI 304 - einstellbarer Thermostat.

- IT Piani caldi con piano in vetro temperato. Struttura in acciaio inox AISI 304 - termostato regolabile.
- EN Hot plates with tempered glass top. Stainless steel AISI 304 structure - adjustable thermostat.
- FR Plaques chauffantes avec plan en verre trempé. Structure en acier inox AISI 304 - thermostat réglable.
- DE Heiße Platten mit gehärteter Glasoberfläche. Struktur aus Edelstahl AISI 304 - einstellbarer Thermostat.

	CON PIANO IN ACCIAIO INOX / WITH STAINLESS STEEL HOT PLATE						CON PIANO IN VETRO TEMPERATO WITH TEMPERED GLASS TOP		
	PC4750	PC4752	PC4754	PC5050	PC6040	PC8060	PVC4760	PVC4763	PVC4765
	250 W	450 W	600 W			1000 W	600 W		1000 W
	230V/1N/50-60 Hz								
	+30°C +90°C								
	50 x 35 x 6(h) cm	90 x 45 x 6(h) cm	100 x 50 x 6(h) cm	50 x 50 x 6(h) cm	60 x 40 x 6(h) cm	80 x 60 x 6(h) cm	50 x 50 x 7(h) cm	60 x 40 x 7(h) cm	81 x 61 x 7(h) cm
	200 €	260 €	300 €	260 €	260 €	355 €	370 €	370 €	460 €

# PCC4730



PCC4730

- IT Piano caldo con cupola in plexiglass. Struttura in acciaio inox AISI 304 - termostato regolabile.
- EN Hot plate with Plexiglas dome. Stainless steel AISI 304 structure - adjustable thermostat.
- FR Plaques chauffantes avec clochette en plexiglas. Structure en acier inox AISI 304 - thermostat réglable.
- DE Heiße Platten mit Plexiglashaube. Struktur aus Edelstahl AISI 304 - einstellbarer Thermostat.

	PCC4730
	600 W
	230V/1N/50-60 Hz
	+30°C +90°C
	100 x 50 x 30(h) cm
	595 €

# PCI4711 - PCI4712 PCI4713



PCI4713

- IT Lampade a infrarossi con piano caldo in acciaio inox. Struttura in acciaio inox - termostato regolabile - copertura in policarbonato fumè.
- EN Infrared lamps with stainless steel heated plate. Stainless steel structure - adjustable thermostat - smoky grey polycarbonate lid.
- FR Lampes infrarouges avec plaque chaude en acier inox. Structure en acier inox - thermostat réglable - couvercle en polycarbonate fumé.
- DE Infrarot-Lampen mit Edelstahlwarmplatte. Struktur aus Edelstahl - einstellbarer Thermostat - dunkle Polycarbonatabdeckung.

	PCI4711	PCI4712	PCI4713
	250 + 250 W	450 + 500 W	600 + 750 W
	230V/1N/50-60 Hz		
	+30°C +90°C		
	1 lampada 1 lamp	2 lampade 2 lamps	3 lampade 3 lamps
	45 x 64 x 80(h) cm	85 x 64 x 80(h) cm	127 x 68 x 80(h) cm
	550 €	690 €	845 €

Lampade a raggi infrarossi  
Infrared lamps

## PI4714 - PI4715 - PI4716



## PIA4714 - PIA4715 PIA4716



PIA4716



PIA4715

IT Telaio con lampade a infrarossi.

EN Frame with infrared lamps.

FR Corps avec lampes infrarouges.





DE Rahmen mit Infrarotlampen.





IT Telaio con lampade a infrarossi da appendere.

EN Frame with hanging infrared lamps.

FR Corps avec lampes infrarouges suspendues.

DE Rahmen mit hängenden Infrarotlampen.

	PI4714	PI4715	PI4716
	250 W	500 W	750 W
 1 Ph	230V/1N/50-60 Hz		
	+30°C +90°C		
	1 lampada 1 lamp	2 lampade 2 lamps	3 lampade 3 lamps
	45 x 55 x 70(h) cm	85 x 55 x 70(h) cm	127 x 55 x 70(h) cm
	330 €	430 €	550 €

	PIA4714	PIA4715	PIA4716
	250 W	500 W	750 W
 1 Ph	230V/1N/50-60 Hz		
	+30°C +90°C		
	1 lampada 1 lamp	2 lampade 2 lamps	3 lampade 3 lamps
	45 x 68 x 25(h) cm	85 x 68 x 25(h) cm	128 x 68 x 25(h) cm
	265 €	370 €	465 €

## PCI4717 - PCI4718 PCI4718D













- IT** Lampade a infrarossi con piano caldo in acciaio inox, in diversi modelli. Struttura in acciaio inox e termostato regolabile.
- EN** Infrared lamps with stainless steel hot plate, in different models. Stainless steel structure and adjustable thermostat.
- FR** Lampes infrarouges avec plaque chauffante en acier inox, en différents modèles. Structure en acier inox et thermostat réglable.
- DE** Infrarotlampen mit Heizplatte aus Edelstahl, in verschiedenen Ausführungen. Edelstahlstruktur und einstellbarer Thermostat.

## BI4719 - BI4719D



- IT** Lampade a infrarossi con contenitore Gastronorm GN1/1 (h) max. 150 mm. Struttura in acciaio inox.
- EN** Infrared lamps with Gastronorm GN1/1 container (h) max. 150 mm. Stainless steel structure.
- FR** Lampes infrarouges avec récipient Gastronorm GN1/1 (h) max. 150 mm. Structure en acier inox.
- DE** Infrarotlampen mit Gastronorm-Behälter GN1/1 (h) max. 150 mm. Edelstahlstruktur.

	PCI4717	PCI4718	PCI4718D
	250 + 250 + 250 W	250 + 250 W	250 + 250 + 250 W
	230V/1N/50-60 Hz		
	+30°C +90°C		
	2 lampade 2 lamps	1 lampada 1 lamp	2 lampade 2 lamps
	60 x 40 x 68(h) cm	58 x 33 x 68(h) cm	
	420 €	340 €	410 €

	BI4719	BI4719D	A516
	250 W		Vasca riscaldata Heated bowl Cuve chauffée Beheizte Wanne
	230V/1N/50-60 Hz		
	+30°C +90°C		
	1 lampada 1 lamp	2 lampade 2 lamps	
	60 x 33 x 68(h) cm		
	380 €	460 €	

# HLF - HLC - HLA - HLE



IT Lampade riscaldanti a infrarossi a sospensione - lunghezza del cavo minima 600 mm e massima 1500 mm - comprese di lampada rossa riscaldante - disponibili in diverse forme come da foto, nei colori nero, argento, oro e rame.

EN Infrared hanging heating lamps - minimum cable length 600 mm and maximum 1500 mm - including red heating lamp - available in different shapes as shown in the picture, in black, silver, gold and copper.

FR Lampes chauffantes à infrarouge à suspension - longueur minimale du câble de 600 mm et maximale de 1500 mm - avec lampe chauffante rouge - disponibles en différentes formes comme indiqué sur la photo, en noir, argent, or et cuivre.

DE Infrarot-Heizlampen zum Aufhängen - Kabellänge mindestens 600 mm und höchstens 1500 mm - einschließlich roter Heizlampe - erhältlich in verschiedenen Formen, wie auf dem Bild gezeigt, in Schwarz, Silber, Gold und Kupfer.

	HLFN nero-black	HLFA argento-silver	HLEFD oro-gold	HLEFB rame-copper
	250 W			
	230V/1N/50-60 Hz			
	+30°C +90°C			
	ø 27 cm			
	95 €	95 €	120 €	120 €

	HLAN nero-black	HLAA argento-silver	HLEBD oro-gold	HLEBB rame-copper
	250 W			
	230V/1N/50-60 Hz			
	+30°C +90°C			
	ø 17,5 cm			
	90 €	90 €	100 €	100 €

	HLCN nero-black	HLCA argento-silver	HLECD oro-gold	HLECB rame-copper
	250 W			
	230V/1N/50-60 Hz			
	+30°C +90°C			
	ø 27 cm			
	95 €	95 €	110 €	110 €

	HLEN nero-black	HLEA argento-silver	HLEED oro-gold	HLEEB rame-copper
	250 W			
	230V/1N/50-60 Hz			
	+30°C +90°C			
	ø 29 cm			
	95 €	95 €	110 €	110 €

VBR4751  
VBR4781



VBR4751

VBR4752  
VBR4782



VBR4752

VBR4753  
VBR4783



VBR4753







IT Vetrine riscaldate. Struttura in acciaio inox AISI 304 - fianchi e antine sui due fronti in plexiglass trasparente - termostato regolabile - dispositivo di umidificazione.

EN Heated display cases. Structure in stainless steel AISI 304 - Plexiglas sides and doors on both sides - adjustable thermostat - humidification device.

FR Vitrines chauffées. Structure en acier inox AISI 304 - côtés et portes des deux côtés en plexiglas transparent - thermostat réglable - dispositif d'humidification.

DE Beheizte Vitrinen. Struktur aus Edelstahl AISI 304 - Seiten und Türen auf beiden Seiten aus transparentem Plexiglas - einstellbarer Thermostat - Befeuchtungsvorrichtung.

	VBR4751	VBR4781	VBR4752	VBR4782	VBR4753	VBR4783	PRI50	PRI85
	250 W	400 W	250 W		400 W		250 W	400 W
	230V/1N/50-60 Hz						mod. VBR4751	mod. VBR4781
	+30°C +90°C						VBR4752	VBR4782
	1		2		3		Piano intermedio riscaldato Heated intermediate shelf Étagère intermédiaire chauffée Beheiztes Zwischenfach	
	50 x 35 x 25(h) cm	85 x 35 x 25(h) cm	50 x 35 x 40(h) cm	85 x 35 x 40(h) cm	50 x 35 x 54(h) cm	85 x 35 x 54(h) cm		
	385 €	470 €	515 €	630 €	615 €	750 €	200 €	270 €

Vetrine riscaldanti  
Heated display cases

# VBR4756 VBR4786



VBR4786

# VBN4756 VBN4786



VBN4756

IT Vettrine riscaldate. Struttura in acciaio inox AISI 304 - fianchi e antine sui due fronti in plexiglass trasparente - termostato regolabile - dispositivo di umidificazione.

EN Heated display cases. Structure in stainless steel AISI 304 - Plexiglas sides and doors on both sides - adjustable thermostat - humidification device.

FR Vitrines chauffées. Structure en acier inox AISI 304 - côtés et portes des deux côtés en plexiglas transparent - thermostat réglable - dispositif d'humidification.

DE Beheizte Vitrinen. Struktur aus Edelstahl AISI 304 - Seiten und Türen auf beiden Seiten aus transparentem Plexiglas - einstellbarer Thermostat - Befeuchtungsvorrichtung.

IT Vettrine neutre. Struttura in acciaio inox AISI 304 - fianchi e antine sui due fronti in plexiglass trasparente.

EN Neutral display cases. Structure in stainless steel AISI 304 - clear Plexiglas sides and doors on both sides.

FR Vitrines neutres. Structure en acier inox AISI 304 - côtés et portes des deux côtés en plexiglas transparent.

DE Neutrale Vitrinen. Struktur aus Edelstahl AISI 304 - Seiten und Türen auf beiden Seiten aus transparentem Plexiglas.

	VBR4756	VBR4786
	250 W	400 W
	230V/1N/50-60 Hz	
	+30°C +90°C	
	2	
	50 x 35 x 40(h) cm	85 x 35 x 40(h) cm
	500 €	640 €

	VBN4756	VBN4786
	2	
	50 x 35 x 40(h) cm	85 x 35 x 40(h) cm
	325 €	445 €

# VBN4751 - VBN4781 - VBN4752 VBN4782 - VBN4753 - VBN4783



VBN4782



VBN4753

IT Vetrine neutre. Struttura in acciaio inox AISI 304 - fianchi e antine sui due fronti in plexiglass trasparente.

EN Neutral display cases. Structure in stainless steel AISI 304 - clear Plexiglas sides and doors on both sides.

FR Vitrines neutres. Structure en acier inox AISI 304 - côtés et portes des deux côtés en plexiglass transparent.

DE Neutrale Vitrinen. Struktur aus Edelstahl AISI 304 - Seiten und Türen auf beiden Seiten aus transparentem Plexiglas.



VBN4751

	VBN4751	VBN4781	VBN4752	VBN4782	VBN4753	VBN4783
	1		2		3	
	50 x 35 x 25(h) cm	85 x 35 x 25(h) cm	50 x 35 x 36(h) cm	85 x 35 x 36(h) cm	50 x 35 x 50(h) cm	85 x 35 x 50(h) cm
	210 €	285 €	330 €	440 €	430 €	575 €

Vetrine neutre  
Neutral display cases

## VBE50 - VBE85



VBE50



VBE85

## VL4748 - VL4749



VL4748B



VL4749



NOCE/WALNUT



LACCATO BIANCO  
LAQUERED WHITE



CARBON

IT Vetrina porta brioches e croissant. Struttura unica completamente in plexiglass con antine apribili sui due lati.

EN Brioches and croissants display case. Single structure completely in plexiglas with openable doors on both sides.

FR Vitrine pour brioches et croissants. Structure unique entièrement en plexiglas avec portes qui peuvent être ouvertes des deux côtés.

DE Vitrine für Croissants und Hörnchen. Struktur komplett aus Plexiglas mit zweiseitig aufklappbaren Türen.

IT Vetrina porta brioches e croissant. Piano in legno. Cupola in plexiglass semitrasparente con antine apribili sui 2 lati.

EN Brioches and croissants display case. Wooden top. Semi-transparent plexiglas dome with openable doors on 2 sides.

FR Vitrine pour brioches et croissants. Plan en bois. Clochette en plexiglas semi-transparent avec portes qui peuvent être ouvertes des deux côtés.

DE Vitrine für Croissants und Hörnchen. Halbtransparente Plexiglashaube zweiseitig aufklappbare Türen.

	STRUTTURA IN PLEXIGLASS PLEXIGLAS STRUCTURE		PIANO IN LEGNO / WOODEN TOP					
i	VBE50	VBE85	VL4748 noce/walnut	VL4748CA carbon	VL4748B laccato bianco laquered white	VL4749 noce/walnut	VL4749CA carbon	VL4749B laccato bianco laquered white
N.	1		1					
cm	50 x 35 x 18(h) cm	85 x 35 x 18(h) cm	50 x 35 x 21(h) cm			85 x 35 x 21(h) cm		
	180 €	240 €	240 €	240 €	250 €	290 €	290 €	300 €

MS1860RF2  
MS1862RF2  
MS1866RF2









MS1862RF2

**IT** Mobiletto scaldapiatti. Struttura in acciaio inox AISI 304 coibentata - termostato regolabile - 1 ripiano intermedio - ruote multidirezionali  $\varnothing$  95 mm di cui 2 con freno.

**EN** Plate warmer cabinet. AISI 304 stainless steel structure insulated - adjustable thermostat - 1 intermediate shelf - multidirectional wheels  $\varnothing$  95 mm - 2 wheels with brake.

**FR** Armoire chauffe-plat. Structure en acier inox AISI 304 isolée - thermostat réglable - 1 étagère intermédiaire - roues multidirectionnelles de  $\varnothing$  95 mm - 2 roues avec frein.

**DE** Tellerwärmer Schrank. Struktur aus Edelstahl AISI 304 isolierte - einstellbarer Thermostat - 1 Zwischenablage - Mehrwegräder  $\varnothing$  95 mm - 2 mit Bremse.

	MS1860RF2	MS1862RF2	MS1866RF2
	800 W		
 1 Ph	230V/1N/50-60 Hz		
	+30°C +90°C		
	60 piatti / plates - Max $\varnothing$ 31 cm 1 porta / doors	100 piatti / plates - Max $\varnothing$ 31 cm 2 porte / doors	120 piatti / plates - Max $\varnothing$ 31 cm 2 porte / doors
 cm	33 x 34,7 x 66,5(h) cm	64 x 34,7 x 53(h) cm	64 x 34,7 x 66,5(h) cm
 cm	39 x 42 x 95(h) cm	70 x 42 x 80(h) cm	70 x 42 x 95(h) cm
	1.195 €	1.400 €	1.560 €

Mobiletto scaldapiatti  
Plate warmer cabinet

## RTR97L



RTR97L

## RTR97L2



RTR97L2

## RTR137L



RTR137L









**IT** Vetrine riscaldate - statiche - con griglie - modelli da banco - doppio vetro - struttura in acciaio inox AISI 304 - fianchi e antine sui due fronti in plexiglass trasparente - unica apertura da parte dell'operatore - termostato regolabile.

**EN** Heated display cases - statics- counter-top versions with grids - double-glazed - structure in stainless steel AISI 304 - clear plexiglass sides and doors on both sides - single opening on the operator's side - adjustable thermostat.

**FR** Vitrines chauffées - statique - de table avec grilles - double vitrage - structure en acier inox AISI 304 - côtés et portes des deux faces en plexiglas transparent - ouverture unilatérale du côté opérateur - thermostat réglable.

**DE** Beheizte Vitrinen - Statische -Tischmodell mit Gitter etc. Doppelglas - Struktur aus Edelstahl AISI 304 - Seiten und Türen auf beiden Seiten aus transparentem Plexiglas - Öffnung nur auf der Bedienerseite - einstellbarer Thermostat.

	RTR97L	RTR97L2	RTR137L
	400 W		
 1 Ph	230V/1N/50-60 Hz		
	+30°C +90°C		
 N.	3 piani / shelves	4 piani tondi rotanti / rotating round shelves (ø 35 cm)	3 piani / shelves
 cm	46 x 45 x 78,5(h) cm		64,5 x 45 x 78,5(h) cm
	800 €	885 €	895 €



Vetrine riscaldanti con griglie  
Heated display cases with grids

forcar®

# VPH100 - VPH120 VPH160



VPH100

**IT** Vetrine riscaldate con griglie - doppio vetro - struttura in acciaio inox AISI 304 - termostato regolabile.

**EN** Heated display cases, with grids - double-glazed - structure in stainless steel AISI 304 - adjustable thermostat.

**FR** Vitrines chauffées, avec grilles - double vitrage - structure en acier inox AISI 304 - thermostat réglable.

**DE** Beheizte Vitrinen, mit Gitter - Doppelglas - Struktur aus Edelstahl AISI 304 - einstellbarer Thermostat.

	VPH100	VPH120	VPH160
	1100 W		
	230V/1N/50-60 Hz		
	+30°C +90°C		
	2 piani / shelves 2 griglie / grids		
	71 x 46 x 67(h) cm	71 x 58 x 67(h) cm	88 x 58 x 67(h) cm
	675 €	885 €	1.055 €

# HTH125F - HTH165F



HTH125F

VPH100	VPH120 - HTH125F	VPH160 - HTH165F
Griglie incluse - Grids included		
GRC100A (up) 64,2 x 27,6 cm	GRC120A (up) 64,2 x 37,6 cm	GRC160A (up) 82 x 37,6 cm
GRC100B (down) 64,2 x 31,2 cm	GRC120B (down) 64,2 x 41,2 cm	GRC160B (down) 82 x 41,2 cm

	HTH125F	HTH165F
	800 W	1500 W
	230V/1N/50-60 Hz	
	+30°C +90°C	
	137 L	174 L
	2 piani / shelves 2 griglie / grids	
	69 x 58 x 67(h) cm	87 x 58 x 67(h) cm
	67,4 x 50 x 41(h) cm	85,2 x 50 x 41(h) cm
	885 €	1.055 €





# Carrelli per la cucina

KITCHEN TROLLEYS  
CHARIOTS POUR LA CUISINE  
KÜCHENWAGEN

## CA1450



CA1450

## CA1460



CA1460

## CA1470



CA1470

**IT** Carrelli portavassoio. Struttura e guide in acciaio inox - paracolpi in gomma - ruote multidirezionali  $\varnothing$  125 mm. Predisposti di serie per vassoio GN1/1 - 53x32,5 cm. Realizzabili su richiesta per qualsiasi misura di vassoio, da specificare al momento dell'ordine. Vassoio esclusi.

**EN** Tray trolleys - Stainless steel structure and slides - rubber shock absorbers - multidirectional wheels  $\varnothing$  125 mm. Standard equipped for GN1/1 trays - 53x32,5 cm. Available on request for any tray size, to be mentioned when ordering. Trays not included.

**FR** Chariots porte plateau. Structure et guides en acier inox - butoirs en caoutchouc - roues multidirectionnelles  $\varnothing$  125 mm. Prêt en standard pour plateau GN1/1 - 53x32,5 cm. Disponible sur demande pour toute taille de plateau, à préciser à la commande. Plaques pas compris.

**DE** Tablettwagen. Struktur und Führungen aus Edelstahl - Gummistoßschutz - Mehrwegräder  $\varnothing$  125 mm. Standardmäßig vorgesehen für Bleche GN1/1 - 53x32,5 cm. Erhältlich auf Anfrage für jede Blechgröße, bitte bei der Bestellung angeben. Bleche nicht enthalten.

	CA1450	CA1460	CA1470	A512
 cm	45 x 62 x 175(h) cm	81 x 62 x 175(h) cm	117 x 62 x 175(h) cm	Ruote con freno Wheels with catch Roues avec frein Räder mit Bremse
 MAX Kg	40 Kg	60 Kg	80 Kg	
 N.	10 vassoio / trays	20 vassoio / trays	30 vassoio / trays	
	350 €	530 €	700 €	10 € cad./each

Carrelli portavassoio GN1/1  
GN1/1 tray trolleys

BACINELLE / TEGLIE ETC.  
CONTAINERS / TRAYS ETC.



## CA1450P



## CA1460P



## CA1470P







**IT** Carrelli portavassoi con pannelli laterali in perfix bianco, acciaio inox. Struttura e guide in acciaio inox - paracolpi in gomma - ruote multidirezionali  $\varnothing$  125 mm. Predisposti di serie per vassoi GN1/1 - 53x32,5 cm. Realizzabili su richiesta per qualsiasi misura di vassoio e/o con pannello posteriore, da specificare al momento dell'ordine. Vassoi esclusi.

**EN** Tray trolleys with side panels in white perfix, stainless steel. Stainless steel structure and slides - rubber shock absorbers - multidirectional wheels  $\varnothing$  125 mm. Standard equipped for GN1/1 trays - 53x32,5 cm. Available on request for any tray size and/or with rear panel, to be mentioned when ordering. Trays not included.

**FR** Chariots porte plateaux à panneaux latéraux en perfix blanc, acier inox. Structure et guides en acier inox - butoirs en caoutchouc - roues multidirectionnelles  $\varnothing$  125 mm. Prêt en standard pour plateaux GN1/1 - 53x32,5 cm. Disponible sur demande pour toute taille de plateau et / ou avec panneau arrière, à préciser à la commande. Plaques pas compris.

**DE** Tablettwagen mit Seitenwänden in Weiß Perfix, Edelstahl oder. Struktur und Führungen aus Edelstahl - Gummistoßschutz - Mehrwegräder  $\varnothing$  125 mm. Standardmäßig vorgesehen für Bleche GN1/1 - 53x32,5 cm. Erhältlich auf Anfrage für jede Blechgröße und / oder mit Rückwand, bitte bei der Bestellung angeben. Bleche nicht enthalten.

	CA1450P bianco-white	CA1450PI inox	CA1460P bianco-white	CA1460PI inox	CA1470P bianco-white	CA1470PI inox	A512
	45 x 62 x 175(h) cm		81 x 62 x 175(h) cm		117 x 62 x 175(h) cm		Ruote con freno Wheels with catch Roues avec frein Räder mit Bremse
	40 Kg		60 Kg		80 Kg		
	10 vassoi / trays		20 vassoi / trays		30 vassoi / trays		
	410 €	460 €	580 €	630 €	770 €	820 €	10 € cad./each

## CA1451R



CA1451R

## CA1461R



CA1461RPI

## CA1471R



CA1471R





**IT** Carrelli portavassoi rinforzati, disponibili anche con pannelli laterali in perfix bianco o in acciaio inox. Struttura tubolare in acciaio inox 25x25 mm - guide in acciaio inox di spessore 1,2 mm - paracolpi in gomma - ruote multidirezionali ø 125 mm. Predisposti di serie per vassoi GN1/1 - 53x32,5 cm. Realizzabili su richiesta per qualsiasi misura di vassoio e/o con pannello posteriore, da specificare al momento dell'ordine. Vassoi esclusi.

**EN** Reinforced tray trolleys also available with side panels in white perfix or stainless steel. Stainless steel tubular structure 25x25 mm - stainless steel slides with 1,2 mm thickness - rubber shock absorbers - multidirectional wheels ø 125 mm. Standard equipped for GN1/1 trays - 53x32,5 cm. Available on request for any tray size and/or with rear panel, to be mentioned when ordering. Trays not included.

**FR** Chariots à plateaux renforcés disponibles aussi avec panneaux latéraux en perfix blanc ou acier inox. Structure tubulaire en acier inox 25x25 mm - guides en acier inox épaisseur 1,2 mm - butoir en caoutchouc - roues multidirectionnelles ø 125 mm. Prêt en standard pour plateaux GN1/1 - 53x32,5 cm. Disponible sur demande pour toute taille de plateau et / ou avec panneau arrière, à préciser à la commande. Plaques pas compris.

**DE** Verstärkte Tablettwagen auch mit Seitenwänden aus weißem Perfix oder Edelstahl erhältlich. Struktur aus Edelstahl 25x25 mm - 1,2 mm dicke Edelstahlführungen - Gummistoßschutz - Mehrwegräder ø 125 mm. Standardmäßig vorgesehen für Bleche GN1/1 - 53x32,5 cm. Erhältlich auf Anfrage für jede Blechgröße und / oder mit Rückwand, bitte bei der Bestellung angeben. Bleche nicht enthalten.

	CA1451R	CA1451RP bianco-white	CA1451RPI inox	CA1461R	CA1461RP bianco-white	CA1461RPI inox	CA1471R	CA1471RP bianco-white	CA1471RPI inox	A514
 cm	45 x 62 x 174(h) cm			81 x 62 x 174(h) cm			118 x 62 x 174(h) cm			Ruote con freno Wheels with catch Roues avec frein Räder mit Bremse
 MAX Kg	50 Kg			80 Kg			100 Kg			
 N.	10 vassoi / trays			20 vassoi / trays			30 vassoi / 30 trays			
	430 €	480 €	530 €	660 €	710 €	760 €	850 €	900 €	950 €	16 € cad./each

Carrelli portavassoi GN1/1 rinforzati  
GN1/1 tray trolleys - reinforced

BACINELLE / TEGLIE ETC.  
CONTAINERS / TRAYS ETC.



# CA1455



CA1455PI

# CA1465



CA1465PI

# CA1475



CA1475



**IT** Carrelli portavassoi universali con possibilità di avere pannelli laterali in perfix bianco o in acciaio inox. Struttura in acciaio inox - guide in filo di acciaio cromato - paracolpi in gomma - ruote multidirezionali  $\varnothing$  125 mm. Vassoi esclusi.

**EN** Universal tray trolleys also available with side panels in white perfix or stainless steel. Stainless steel structure - chromed steel wire slides - rubber shock absorbers - multidirectional wheels  $\varnothing$  125 mm. Trays not included.

**FR** Chariots à plateaux universels isponibles aussi avec panneaux latéraux en perfix blanc ou acier inox. Structure en acier inox - glissières en fil d'acier chromé - butoirs en caoutchouc - roues multidirectionnelles  $\varnothing$  125 mm. Plaques pas compris.

**DE** Universal-Tablett Wagen auch mit Seitenwänden aus weißem Perfix oder Edelstahl erhältlich. Struktur aus Edelstahl - verchromte Stahldrahtführungen - Gummistoßschutz - Mehrwegräder  $\varnothing$  125 mm. Bleche nicht enthalten.

	CA1455	CA1455P bianco-white	CA1455PI inox	CA1465	CA1465P bianco-white	CA1465PI inox	CA1475	CA1475P bianco-white	CA1475PI inox	A512
	55 x 62 x 175(h) cm			95 x 62 x 175(h) cm			138 x 62 x 175(h) cm			Ruote con freno Wheels with catch Roues avec frein Räder mit Bremse
	40 Kg			80 Kg			100 Kg			
	10 vassoi / trays			20 vassoi / trays			30 vassoi / trays			
	375 €	425 €	475 €	585 €	635 €	685 €	800 €	850 €	900 €	10 € cad./each

## CA1455V12

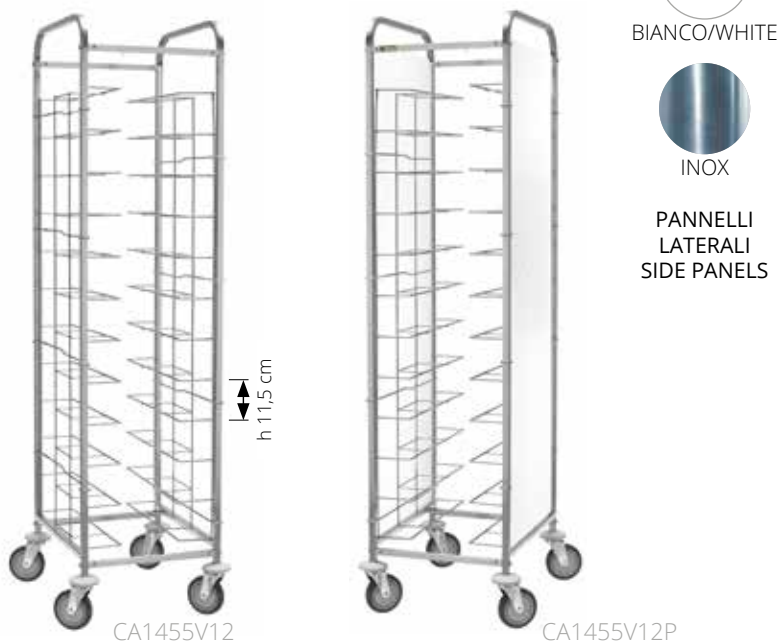

IT Carrello portavassoi universali con possibilità di avere pannelli laterali in perfix bianco o in acciaio inox. Struttura in acciaio inox - guide in filo di acciaio cromato - paracolpi in gomma - ruote multidirezionali  $\varnothing$  125 mm.

EN Universal tray trolleys also available with side panels in white perfix or stainless steel. Stainless steel structure - chromed steel wire slides - rubber shock absorbers - multidirectional wheels  $\varnothing$  125 mm.

FR Chariots à plateaux universels isponibles aussi avec panneaux latéraux en perfix blanc ou acier inox. Structure en acier inox - glissières en fil d'acier chromé - butoirs en caoutchouc - roues multidirectionnelles  $\varnothing$  125 mm.

DE Universal-Tablett Wagen auch mit Seitenwänden aus weißem Perfix oder Edelstahl erhältlich. Struktur aus Edelstahl - verchromte Stahldrahtführungen - Gummistoßschutz - Mehrwegräder  $\varnothing$  125 mm.

i	CA1455V12	CA1455V12P bianco-white	CA1455V12I inox	A512
cm	52 x 62 x 185(h) cm			
MAX Kg	40 Kg			Ruote con freno Wheels with catch Roues avec frein Räder mit Bremse
N.	12 vassoi / trays			
	425 €	475 €	525 €	10 € cad./each

## PT15

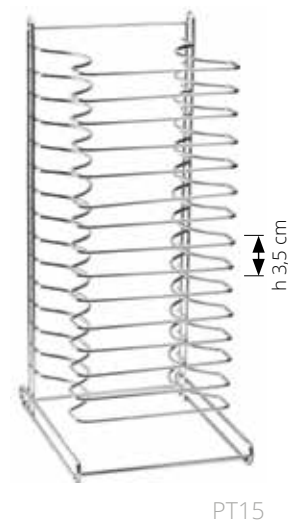

IT Portateglie da banco per teglie tonde da 26 a 32 cm. Confezione minima 4 pz.

EN Table-top tray holder for round trays size 26 to 32 cm. Minimum pack 4 pcs.

FR Porte-plateau de table pour plateaux ronds de 26 à 32 cm. Paquet minimum de 4 pièces.

DE Tisch-Tabletthalterung für runde Tablette von 26 bis 32 cm. Mindestmenge 4 Stück.

i	PT15
cm	38 x 29 x 67(h) cm
MAX Kg	5 Kg
N.	15 teglie / trays
	90 € cad./each - min. 4 pcs

Carrello portavassoi universali  
Universal tray trolleys

BACINELLE / TEGLIE ETC.  
CONTAINERS / TRAYS ETC.



CA1476

CA1477

CA1478

CA1479



CA1476



CA1477



CA1478



CA1479

IT Carrelli portateglie GN. Struttura e guide in acciaio inox - paracolpi in gomma - ruote multidirezionali  $\varnothing$  125 mm. Predisposti di serie per GN2/1 e GN1/1. A richiesta possibilità di altre misure. Teglie escluse.

EN GN pans trolleys Stainless steel structure and slides - rubber shock absorbers - multidirectional wheels  $\varnothing$  125 mm. Standard equipped for GN2/1 and GN1/1. Trays not included.

FR Chariots à plateaux GN. Structure et glissières en acier inox - butoirs en caoutchouc - roues multidirectionnelles  $\varnothing$  125 mm. En standard pour GN2/1 et GN1/1. Autres mesures disponibles sur demande. Plateaux pas compris.

DE GN-Blechwagen. Struktur und Führungen aus Edelstahl - Gummistoßschutz - Mehrwegräder  $\varnothing$  125 mm. Serienmäßig ausgerüstet für GN2/1 und GN1/1. Andere Größen sind auf Anfrage erhältlich. Bleche nicht enthalten.

	CA1476	CA1477	CA1478	CA1479	A512
	64,5 x 72 x 182(h) cm	64,5 x 62 x 94(h) cm	44,5 x 62 x 94(h) cm	44,5 x 62 x 175(h) cm	Ruote con freno Wheels with catch Roues avec frein Räder mit Bremse
	-	58,5 x 66 cm	56 x 39 cm	-	
	80 Kg	50 Kg		40 Kg	
	14x GN2/1 - 28x GN1/1	8x GN2/1 - 16x GN1/1	8x GN1/1	14x GN1/1	
	400 €	440 €	420 €	380 €	10 € cad./each

## CA1489R



CA1489R

## CA1486R



CA1486R

## CA1492R



CA1492R

IT Carrelli portateglie GN rinforzati e Euronorm rinforzati. Struttura tubolare in acciaio inox 25x25 mm - guide in acciaio inox di spessore 1,2 mm - paracolpi in gomma - ruote multidirezionali  $\varnothing$  125 mm. Teglie escluse.

EN Euronorm and GN pans trolleys - reinforced. - reinforced Stainless steel tubular structure 25x25 mm - stainless steel slides with 1,2 mm thickness - rubber shock absorbers - multidirectional wheels  $\varnothing$  125 mm. Trays not included.

FR Chariots à plateaux GN/Euronorm renforcés. Structure tubulaire en acier inox 25x25 mm - glissières en acier inox épaisseur 1,2 mm - butoir en caoutchouc - roues multidirectionnelles  $\varnothing$  125 mm. Plateaux pas compris.

DE Verstärkte GN/Euronorm - Blechwagen. Edelstahlrohrstruktur 25x25 mm - 1,2 mm dicke Edelstahlführungen - Gummistoßschutz - Mehrwegräder  $\varnothing$  125 mm. Bleche nicht enthalten.

	CA1489R	CA1486R	CA1492R	A514
 cm	45,5 x 62 x 177(h) cm	65,5 x 72 x 181(h) cm	53 x 72 x 181(h) cm	Ruote con freno Wheels with catch Roues avec frein Räder mit Bremse
 MAX Kg	60 Kg	90 Kg		
 N.	14x GN1/1	14x GN2/1 - 28x GN1/1	Teglie / trays 14 x 60 x 40 cm	
	500 €	545 €	520 €	16 € cad./each

Carrelli portateglie GN1/1 - GN2/1 - rinforzati  
GN1/1 - GN2/1 - pans trolleys - reinforced

BACINELLE / TEGLIE ETC.  
CONTAINERS / TRAYS ETC.



## CA1480 - CA1480D



IT Carrelli portateglie universali. Struttura e guide in acciaio inox - paracolpi in gomma - ruote multidirezionali  $\varnothing$  125 mm. Teglie escluse.

EN Universal tray trolleys. Stainless steel structure and slides - rubber shock absorbers - multidirectional wheels  $\varnothing$  125 mm. Trays not included.

FR Chariots à plateaux universels. Structure et glissières en acier inox - butoirs en caoutchouc - roues multidirectionnelles  $\varnothing$  125 mm. Plateaux pas compris.

DE Universal-Blechwagen. Struktur und Führungen aus Edelstahl - Gummistoßschutz - Mehrwegräder  $\varnothing$  125 mm. Bleche nicht enthalten.

## CA1650 - CA1655 CA1656



IT Carrelli portateglie 60x40 cm e porta bacinelle GN1/1 65(h) mm. Struttura in acciaio inox - guide in filo di acciaio cromato - paracolpi in gomma - ruote multidirezionali  $\varnothing$  125 mm. Bacinelle e teglie escluse.

EN Tray trolleys 60x40 cm and trays GN1/1 65(h) mm. Stainless steel structure - chromed steel wire slides - rubber shock absorbers - multidirectional wheels  $\varnothing$  125 mm. Containers and pans not included.

FR Chariots à plateaux 60x40 cm et pour bacs GN1/1 65(h) mm. Structure en acier inox - glissières en fil d'acier chromé - butoirs en caoutchouc - roues multidirectionnelles  $\varnothing$  125 mm. Bacs et plaques pas compris.

DE Tablett Wagen 60x40 cm und Tablett GN1/1 65(h) mm. Struktur aus Edelstahl - verchromte Stahldrahtführungen - Gummistoßschutz - Mehrwegräder  $\varnothing$  125 mm. Behältern und Bleche nicht enthalten.

i	CA1480	CA1480D	A514
cm	50 x 51 x 177(h) cm	50 x 81 x 177(h) cm	Ruote con freno Wheels with catch Roues avec frein Räder mit Bremse
MAX Kg	40 Kg	80 Kg	
N.	20 teglie / trays	40 teglie / trays	
	450 €	535 €	16 € cad./each

i	CA1650	CA1655	CA1656	A512
cm	51,5 x 67 x 175(h) cm	67 x 46 x 117(h) cm	67 x 46 x 153(h) cm	Ruote con freno Wheels with catch Roues avec frein Räder mit Bremse
N.	GN1/1 65(h) mm 10 teglie / trays 60x40 cm e vassoio / trays	GN1/1 65(h) mm 10 teglie / trays 60x40 cm	GN1/1 65(h) mm 15 teglie / trays 60x40 cm	
	390 €	380 €	460 €	
				10 € cad./each

## CA1482 - CA1482T20



## CA1483 - CA1493



IT Carrelli portateglie per pasticceria. Struttura e guide in acciaio inox - paracolpi in gomma - ruote multidirezionali  $\varnothing$  125 mm. A richiesta altre misure disponibili. Teglie escluse.

EN Pastry tray trolleys. Stainless steel structure and slides - rubber shock absorbers - multidirectional wheels  $\varnothing$  125 mm. Other sizes available on request. Trays not included.

FR Chariots à plateaux pâtisserie. Structure et glissières en acier inox - butoirs en caoutchouc - roues multidirectionnelles  $\varnothing$  125 mm. Autres mesures disponibles sur demande. Plateaux pas compris.

DE Konditorei-Blechwagen. Struktur und Führungen aus Edelstahl - Gummistoßschutz - Mehrwegräder  $\varnothing$  125 mm. Andere Größen sind auf Anfrage erhältlich. Bleche nicht enthalten.

	CA1482	CA1482T20	CA1483	CA1493	A512
	52 x 72 x 182(h) cm		52 x 72 x 94(h) cm	72 x 87 x 94(h) cm	Ruote con freno Wheels with catch Roues avec frein Räder mit Bremse
	-		66 x 46 cm	66 x 81 cm	
	80 Kg		50 Kg		
	14 teglie / trays 60x40 cm	20 teglie / trays 60x40 cm	8 teglie / trays 60x40 cm	8 teglie / trays 80x60 cm 16 teglie / trays 60x40 cm	
	430 €	530 €	450 €	560 €	10 € cad./each

Carrelli portateglie per pasticceria  
Pastry tray trolleys

BACINELLE / TEGLIE ETC.  
CONTAINERS / TRAYS ETC.



# HE290 - HE540



HE290



	HE290	HE540
	800 W	1500 W
	230V/1N/50 Hz	
	+30°C +90°C	
	290 L - GN1/1 - 20 pcs	540 L - GN2/1 - 20 pcs
	83 x 67,2 x 177,6(h) cm	95 x 87,7 x 177,6(h) cm
	65 x 39,5 x 143(h) cm	77 x 60 x 143(h) cm
	1.485 €	1.750 €

**IT** Carrelli portateglie GN1/1 e GN2/1 armadiati e riscaldati. Struttura ed interno in acciaio inox AISI 304 - maniglie laterali per conduzione carrello - porte non reversibili - isolamento 60 mm - riscaldamento ventilato - termostato di tipo meccanico - mantiene 70°C di temperatura fino ad un'ora dallo spegnimento - ruote multidirezionali ø 125 mm di cui due con freno.

**EN** Heated GN1/1 and GN2/1 cupboard trolleys. Stainless steel AISI 304 structure and interior - side handles for trolley guidance - non-reversible doors - 60 mm insulation - ventilated heating - mechanical thermostat - maintains 70°C temperature up to one hour after switching off - multi-directional wheels ø 125 mm, two of which with brake.

**FR** Chariots chauffés sur élément fermé GN1/1 et GN2/1. Structure et intérieur en acier inox AISI 304 - poignées latérales pour le déplacement du chariot - portes non réversibles - isolation de 60 mm - chauffage ventilé - thermostat mécanique - maintien de la température à 70°C jusqu'à une heure après l'arrêt - roues multidirectionnelles ø 125 mm, dont deux avec frein.

**DE** Beheizte GN1/1 und GN2/1 Wagen mit Schrankelement. Struktur und Innenraum aus Edelstahl AISI 304 - seitliche Lenkgriffe für die Führung des Wagens - nicht umkehrbare Türen - 60 mm Isolierung - belüftete Heizung - mechanischer Thermostat - hält die Temperatur von 70°C bis zu einer Stunde nach dem Ausschalten aufrecht - Mehrzweckräder ø 125 mm, zwei davon mit Bremse.



# G-HR290 - G-HR540



G-HR540



	G-HR290	G-HR540
	220 W	260 W
	230V/1N/50 Hz	
	-2°C +8°C	
	290 L - GN1/1 - 20 pcs	540 L - GN2/1 - 20 pcs
	83 x 67,2 x 203(h) cm	95 x 87,7 x 203(h) cm
	65 x 39,5 x 143(h) cm	77 x 60 x 143(h) cm
	+40°C / 55%HR	
	ventilato / ventilated	
<b>DEFROST</b>	automatico / automatic	
<b>GAS</b>	R600a	
	automatico / automatic	
	elettronico / electronic	
<b>CONTROL</b>	60 mm	
<b>MATERIAL</b>	acciaio Inox / stainless steel AISI 304	
<b>REVERSIBLE</b>	si / yes	
	no	
<b>ENERGY CLASS</b>		
	1.850 €	2.080 €

**IT** Carrelli portateglie GN1/1 e GN2/1 refrigerati. Struttura ed interno in acciaio inox AISI 304 - maniglie laterali per conduzione carrello - porte reversibili - isolamento 60 mm - refrigerazione ventilata - ruote multidirezionali ø 125 mm di cui due con freno.

**EN** GN1/1 and GN2/1 refrigerated trolleys. AISI 304 stainless steel frame and interior - side handles for trolley guidance - reversible doors - 60 mm insulation - ventilated refrigeration - multidirectional wheels ø 125 mm, two of which with brake.

**FR** Chariots réfrigérés GN1/1 et GN2/1. Corps et intérieur en acier inox AISI 304 - poignées latérales pour le guidage du chariot - portes réversibles - isolation de 60 mm - réfrigération ventilée - roues pivotantes ø 125 mm, dont deux avec frein.

**DE** Gekühlte Servierwagen GN1/1 und GN2/1. Rahmen und Innenraum aus Edelstahl AISI 304 - seitliche Griffe für die Wagenführung - umkehrbare Türen - 60 mm Isolierung - belüftete Kühlung - Mehrzweckräder ø 125 mm, davon zwei mit Bremse.

Carrelli portateglie GN1/1 - GN2/1 armadiati e refrigerati  
Refrigerated GN1/1 and GN2/1 cupboard trolleys





# Carrelli

portapiatti e cestelli

PLATE AND BASKETS TROLLEYS  
PORTE-ASSIETTES ET PANIERS  
TELLER- UND KORBWAGEN

# CA1435 - CA1436 CA1435G - CA1436G

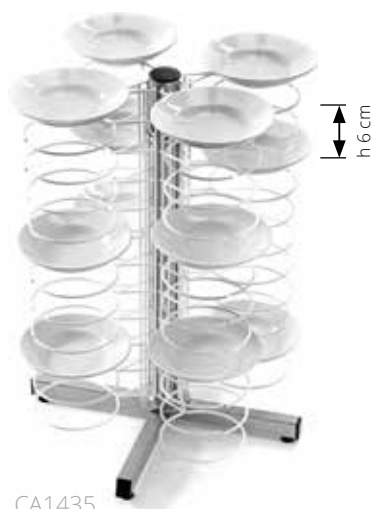

h 6 cm



Dimensioni di imballo  
Packing dimensions  
90 x 30 x 50(h) cm



CA1435

- IT Colonna portapiatti da banco. Struttura in acciaio plastificato - griglie verniciate o cromate - piedini regolabili.
- EN Countertop tiered plate holder stand. Plastic-coated steel structure - painted or chromed grids - adjustable feet.
- FR Colonne porte-assiettes de table. Structure en acier plastifié - grilles peintes ou chromées - pieds réglables.
- DE Tellerwagen, Tischmodell. Struktur aus kunststoffbeschichtetem Stahl - lackierte oder verchromte Gitter - verstellbare Füße.

	CA1435 griglie verniciate painted grid	CA1436 griglie cromate chrome-plated grill	CA1435G griglie verniciate painted grid	CA1436G griglie cromate chrome-plated grill
	60 x 60 x 83(h) cm		70 x 70 x 83(h) cm	
	48 piatti / plates ø 18/23 cm		48 piatti / plates ø 25/31 cm	
	380 €	400 €	390 €	450 €

Portapiatti  
Plate rack

# CA1437 - CA1438 CA1437G - CA1438G

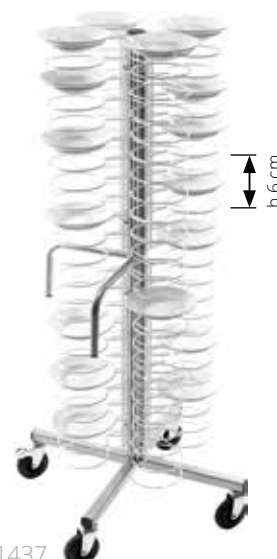

h 6 cm



Dimensioni di imballo  
Packing dimensions  
165 x 35 x 50(h) cm



CA1437

- IT Carrelli portapiatti. Struttura in acciaio plastificato - griglie verniciate o cromate - maniglie per conduzione carrello - ruote ø 125 mm di cui due con freno.
- EN Plate trolleys. Plastic-coated steel structure - painted or chrome-plated grids - handles for trolley operation - ø 125 mm wheels, two of which with brakes.
- FR Chariots à assiettes. Structure en acier plastifié - grilles peintes ou chromées - poignées pour l'entraînement du chariot - roues de ø 125 mm, dont deux avec freins.
- DE Tellerwagen. Struktur aus kunststoffbeschichtetem Stahl - lackierte oder verchromte Gitter - Lenkergriff - Räder ø 125 mm, davon zwei mit Bremsen.

	CA1437 griglie verniciate painted grid	CA1438 griglie cromate chrome-plated grill	CA1437G griglie verniciate painted grid	CA1438G griglie cromate chrome-plated grill
	60 x 60 x 173(h) cm		70 x 70 x 173(h) cm	
	96 piatti / plates ø 18/23 cm		96 piatti / plates ø 25/31 cm	
	660 €	685 €	700 €	735 €



Confezionamento in kit per risparmio costi trasporto  
Packing in set for saving transport charges  
Emballage en kit pour sauver frais d'expédition  
Verpackung in kit um Versandkosten zu sparen

# CA1439P



Dimensioni di imballo  
Packing dimensions  
80 x 30 x 40(h) cm

CP1439P

IT Portapiatti da parete. Struttura in acciaio plastificato - griglie plastificate.

EN Wall plate holder. Plastic-coated steel structure - plastic-coated grids.

FR Porte-assiettes à mur. Structure en acier plastifié - grilles plastifiées.

DE Wandtellerhalter. Kunststoffbeschichtete Stahlstruktur - beschichtete Gitter.



Confezionamento in kit per risparmio costi trasporto  
Packing in set for saving transport charges  
Emballage en kit pour sauver frais d'expédition  
Verpackung in kit um Versandkosten zu sparen

	CA1439P
	42 x 20 x 90(h) cm
	12 piatti / plates ø 18/23 cm
	110 €

# CA1439 - CA1440 CA1439G - CA1440G

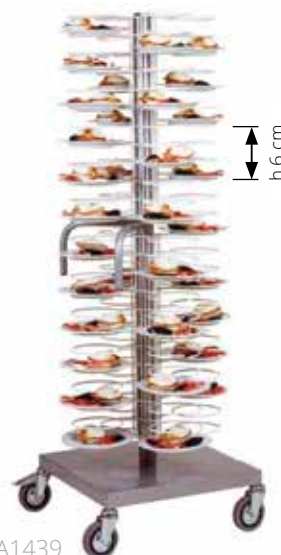

GRIGLIA  
VERNICIATA  
PAINTED  
GRID



GRIGLIA  
CROMATA  
CHROME  
PLATED GRID

CA1439

IT Carrelli portapiatti. Struttura in acciaio plastificato con base in lamiera antipolvere - griglie verniciate o cromate - maniglie per conduzione carrello - ruote ø 125 mm di cui due con freno.

EN Plate trolleys. Plastic-coated steel structure with dust-proof lower shelf - painted or chrome-plated grids - handles for trolley operation - ø 125 mm wheels, two of which with brakes.

FR Chariots à assiettes. Structure en acier plastifié avec base en tôle anti-poussière - grilles peintes ou chromées - poignées pour l'entraînement du chariot - roues de ø 125 mm, dont deux avec freins.

DE Tellerwagen. Struktur aus kunststoffbeschichtetem Stahl mit staubdichtem Boden - lackierte oder verchromte Gitter - Lenkergriff - Räder ø 125 mm, davon zwei mit Bremsen.

	CA1439 griglie verniciate painted grid	CA1440 griglie cromate chrome-plated grill	CA1439G griglie verniciate painted grid	CA1440G griglie cromate chrome-plated grill
	60 x 60 x 175(h) cm		70 x 70 x 175(h) cm	
	96 piatti / plates ø 18/23 cm		96 piatti / plates ø 25/31 cm	
	780 €	810 €	820 €	895 €

# CP1441 - CP1441C



CP1441

CP1441C

**IT** Carrelli per il trasporto piatti. Struttura in tubo di acciaio inox - ripiano portapiatti e pannellatura in lamiera di acciaio inox - ruote multidirezionali ø 125 mm.

**EN** Dish transport trolleys. Structure in stainless steel tube - stainless steel plate shelf and panelling - multidirectional wheels ø 125 mm.

**FR** Chariots pour transporter la vaisselle. Structure en tube d'acier inox - étagère et revêtement en tôle d'acier inox - roues multidirectionnelles ø 125 mm.

**DE** Geschirrwagen. Edelstahlrohrstruktur - Tellerablage und Verkleidung aus Edelstahlblech - Mehrwegräder ø 125 mm.

	CP1441	CP1441C
	91 x 57 x 101(h) cm	
	1	2
	100 Kg	
	200 piatti / plates	
	-	80 x 50 cm
	440 €	580 €

# OPTIONAL



A1001

A1002

CP1441C

A1001	A1002	A512
mod. CP1441 - CP1441C		
Cestino piccolo Small basket Petit panier Klein Korb	Cestino grande Big basket Grand panier Gros Korb	Ruote con freno Wheels with catch Roues avec frein Räder mit Bremse
15 €	30 €	10 € cad./each

A410	A420
mod. CA1439 - CA1440	mod. CA1439G - CA1440G
Copertura in PVC con 4 cerniere PVC lid with 4 hinges Couverture en PVC avec 4 charnières PVC-Abdeckung mit 4 Scharnieren	
360 €	420 €

Carrelli per il trasporto piatti  
Dish transport trolleys

# CG1439A



CG1439A



# CA1439A - CA1440A CA1439AG - CA1440AG

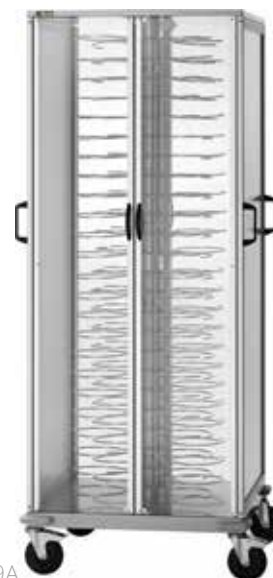

CA1439A

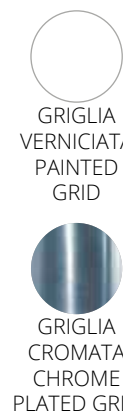

**IT** Carrelli portapiatti armadiati. Struttura portante in acciaio plastificato - telaio in alluminio anodizzato - pannellatura in perflex con 4 sportelli apribili in plexiglass - griglie verniciate o cromate - maniglie laterali per conduzione carrello - ruote multidirezionali  $\varnothing$  125 mm di cui due con freno.

**EN** Cabinet plate trolleys. Supporting structure in plastic-coated steel - anodized aluminium frame - perflex panelling with 4 openable Plexiglas doors - painted or chrome-plated grids - side handles for trolley operation - multidirectional wheels  $\varnothing$  125 mm, two of which with brakes.

**FR** Chariots porte-assiettes sur élément fermé. Structure portante en acier plastifié - corps en aluminium anodisé - panneaux en perflex avec 4 portes ouvrantes en plexiglas - grilles peintes ou chromées - poignées latérales pour le déplacement - roues multidirectionnelles  $\varnothing$  125 mm dont deux avec frein.

**DE** Tellerwagen mit Schrankelement. Tragstruktur aus kunststoffbeschichtetem Stahl - Rahmen aus eloxiertem Aluminium - Blenden in Perflex mit 4 Flügeltüren aus Plexiglas - lackierte oder verchromte Gitter - seitliche Lenkergriffe - Mehrwegräder  $\varnothing$  125 mm, zwei davon mit Bremsen.

	CG1439A griglie verniciate / painted grid
	75 x 78 x 170(h) cm
	10 griglie verniciate / painted grids GN2/1
	1.980 €

	CA1439A griglie verniciate painted grid	CA1440A griglie cromate chrome-plated grill	CA1439AG griglie verniciate painted grid	CA1440AG griglie cromate chrome-plated grill
	75 x 78 x 183(h) cm			
	88 piatti / plates $\varnothing$ 18/23 cm		88 piatti / plates $\varnothing$ 25/31 cm	
	1.850 €	1.940 €	1.840€	1.950 €

## CG1439AC



CG1439AC



**IT** Carrelli portapiatti armadiati e riscaldati. Struttura portante in acciaio plastificato - termostato regolabile - telaio in alluminio anodizzato - pannellatura in perflex con n. 4 sportelli apribili in plexiglass - griglie verniciate o cromate maniglie laterali per conduzione carrello - ruote ø 125 mm di cui due con freno.

**EN** Heated cabinet plate trolleys. Supporting structure in plastic-coated steel - adjustable thermostat - anodized aluminium frame - perflex panelling with 4 openable Plexiglas doors - painted or chrome-plated grids - side handles for trolley operation - multidirectional wheels ø 125 mm, two of which with brakes.

	CG1439AC griglie verniciate / painted grid	
	800 + 800 W	
	230V/1N/50-60 Hz	
	max 60°C	
	10 griglie verniciate / painted grids GN2/1	
	75 x 78 x 177(h) cm	
	2.790 €	

## CA1440AC CA1440ACG



CA1440AC



**FR** Chariots porte-assiettes chauffantes sur élément fermé. Structure portante en acier plastifié - thermostat réglable - corps en aluminium anodisé - panneaux en perflex avec 4 portes ouvrables en plexiglas - grilles chromées - poignées latérales pour le déplacement- roues ø 125 mm, dont deux avec frein.

**DE** Beheizter Tellerwagen und mit Schrankelement. Tragstruktur aus Kunststoffbeschichtetem Stahl. Einstellbarer Thermostat Rahmen aus eloxiertem Aluminium. Blenden in Perflex mit 4 Flügeltüren aus Plexiglas. Verchromte Gitter Seitliche Lenkergriffe - Räder diam. 125 mm, zwei davon mit Bremsen.

	CA1440AC griglie cromate / chrome-plated grill	CA1440ACG griglie cromate / chrome-plated grill
	800 + 800 W	
	230V/1N/50-60 Hz	
	max 60°C	
	88 piatti / plates ø 18/23 cm	88 piatti / plates ø 25/31 cm
	75 x 78 x 177(h) cm	
	2.650 €	2.670 €

Carrelli portapiatti armadiati riscaldati  
Heated cabinet plate trolleys

## CG1439R



CG1439R

## CA1439R CA1439RG

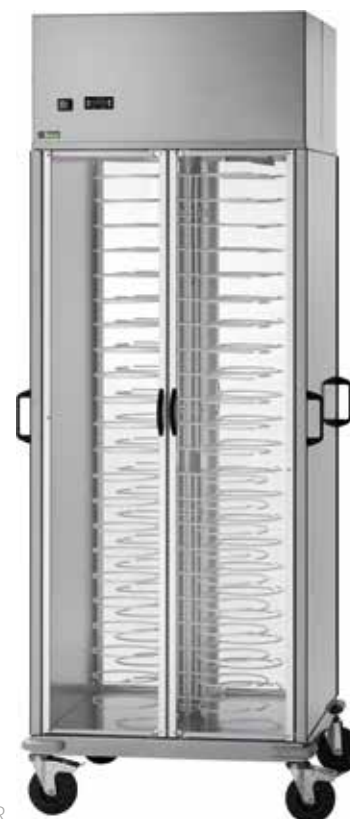

CA1439R

i	CG1439R	CA1439R	CA1439RG
⚡	460 W		
1 Ph	230V/1N/50-60 Hz		
🌡️	+8°C +12°C		
🔥	R290		
↗️ cm	75 x 78 x 203(h) cm		
❄️	ventilato / ventilated		
H <sub>2</sub> O	automatico / automatic		
CONTROL	elettronico / electronic		
	10 griglie / grills x GN2/1	88 piatti / plates ø 18/23 cm	88 piatti / plates ø 25/31 cm
	3.300 €	3.150 €	3.200 €

**IT** Carrelli portapiatti refrigerati. Struttura portante in acciaio plastificato - telaio in alluminio anodizzato - pannellatura in isomac spessore 25 mm con 4 sportelli apribili in plexiglass - griglie plastificate - maniglie laterali per conduzione carrello - ruote ø 125 mm di cui due con freno.

**EN** Refrigerated cabinet plate trolleys. Supporting structure in plastic-coated steel - anodized aluminium frame - isomac panelling with 25 mm thickness and 4 openable Plexiglas doors - plastic coated grids - side handles for trolley operation - multidirectional wheels ø 125 mm, two of which with brakes.

**FR** Chariots porte-assiettes réfrigérées. Structure portante en acier plastifié - corps en aluminium anodisé - panneaux en isomac épaisseur 25 mm avec 4 portes ouvrantes en plexiglas - grilles plastifiées - poignées latérales pour le déplacement - roues ø 125 mm dont deux avec frein.

**DE** Gekühlte Tellerwagen. Tragstruktur aus kunststoffbeschichtetem Stahl - Rahmen aus eloxiertem Aluminium - 25 mm starke Isomac-Blenden mit 4 Flügeltüren aus Plexiglas - kunststoffbeschichtete Gitter - seitliche Lenkergriffe - Räder ø 125 mm, zwei davon mit Bremsen.

## CP1442



CP1442

- IT Carrello portacestelli per lavastoviglie. Struttura tubolare in acciaio inox. Ruote multidirezionali  $\varnothing$  125 mm - cestelli non inclusi.
- EN Dishwasher trolley. Stainless steel tubular structure. Multidirectional wheels  $\varnothing$  125 mm - baskets not included.
- FR Chariot pour lave-vaisselle. Structure tubulaire en acier inox. Roues multidirectionnelles  $\varnothing$  125 mm - paniers pas compris.
- DE Spülmaschinenwagen. Edelstahlrohrstruktur. Mehrwegräder  $\varnothing$  125 mm - Körbe nicht enthalten.

## CA656



CA656

## CA631



CA631

- IT Carrelli per ritiro, distribuzione e stoccaggio vassoi, piatti, tazze, ecc. Telaio in acciaio inox - cesti asportabili in filo di acciaio plastificato - paracolpi - ruote multidirezionali  $\varnothing$  125 mm.
- EN Trolleys for collecting, distributing and storing trays, plates, cups, etc. Stainless steel frame - removable baskets made of plastic-coated steel wire - shock absorbers - multidirectional wheels  $\varnothing$  125 mm.
- FR Chariots de collecte, de distribution et de stockage de plateaux, assiettes, tasses, etc. Structure en acier inox - paniers amovibles en fil d'acier plastifié - butoirs - roues multidirectionnelles  $\varnothing$  125 mm.
- DE Wagen zum Sammeln, Verteilen und Lagern von Tablett, Tellern, Tassen usw. Edelstahlrahmen - abnehmbare Körbe aus kunststoffbeschichtetem Stahldraht - Stoßschutz - Mehrwegräder  $\varnothing$  125 mm.

i	CP1442	A512
cm	65 x 65 x 170(h) cm	
MAX Kg	60 Kg	Ruote con freno Wheels with catch Roues avec frein Räder mit Bremse
	300 €	10 € cad./each

i	CA656	CA631	A512
cm	88 x 50 x 92(h) cm	75 x 65 x 92(h) cm	
	1 cesto / basket	1 cesto / basket	Ruote con freno Wheels with catch Roues avec frein Räder mit Bremse
	100 piatti / plates $\varnothing$ 23 cm	130 vassoi / trays 53x32,5 / 37x53cm	
	440 €	380 €	10 € cad./each

Carrello portacestelli  
Basket trolley

CESTE / BASKETS



## CA1399



CA1399

## CA1400



CA1400

## CA1401



CA1401

IT Carrelli scolapiatti e bicchieri. Telaio in tubo di acciaio inox - ripiani con griglie in acciaio inox per piatti - vaschette scolabicchieri in acciaio inox - piano raccogli gocce in acciaio inox - ruote multidirezionali ø 125 mm.

EN Plates and glasses drainer trolleys. Stainless steel tubular frame - shelves with stainless steel grids for plates - stainless steel glass draining trays - stainless steel drip tray - multidirectional wheels ø 125 mm.

FR Chariots égouttoir assiettes et verres. Structure en tube d'acier inox - étagères avec grilles en acier inox pour assiettes - plateaux d'égouttage pour les verres en acier inox - cuve de récupération en acier inox - roues multidirectionnelles ø 125 mm.

DE Geschirr und Gläser Abtropfwagen. Edelstahlrohrrahmen - Stellflächen mit Edelstahlgittern für Teller - Abtropfschalen für Gläser aus Edelstahl - Tropfschale aus Edelstahl - Mehrwegräder ø 125 mm.

i	CA1399	CA1400	CA1401	A512
↗ cm	110 x 62 x 134(h) cm			110 x 62 x 160(h) cm
	3 scolapiatti - 3 plates drainers ø 23 cm	1 scolabicchieri - 1 glasses drainer 2 scolapiatti - 2 plates drainers	4 scolapiatti - 4 plates drainers	Ruote con freno Wheels with catch Roues avec frein Räder mit Bremse
	770 €	810 €	960 €	10 € cad./each

# SPB1398



SPB1398

IT Pensili scolapiatti e bicchieri da muro. Struttura in acciaio inox lucido 18/8.

EN Hanging plates and glasses drainer. Structure in 18/8 polished stainless steel.

# SP1397



SP1397

FR Égouttoir mural pour assiettes et verres. Structure en acier inox poli 18/8.

DE Geschirr und Gläser Wandabtropfschränke. Struktur aus poliertem Edelstahl 18/8.

	SPB1398
	80 x 26 x 37(h) cm
	ø 23 cm piatti / plates
	100 €

	SP1397
	104 x 30 x 55(h) cm
	ø 23 cm piatti / plates
	215 €

Scolapiatti e bicchieri  
Plates and glasses drainer

# CP1445

# CP1446

# CP1447

# CP1448



IT Carrelli portacestelli per lavastoviglie. Vasca in acciaio inox - disponibile con o senza manico in acciaio inox - ruote multidirezionali  $\varnothing$  100 mm di cui due con freno. Ceste non incluse.

EN Dishwasher basket trolleys. Stainless steel base - available with or without stainless steel handle - multidirectional wheels  $\varnothing$  100 mm, 2 of which fixed. Baskets not included.

FR Chariots porte-paniers pour lave-vaisselle. Fond en acier inox - disponible avec ou sans poignée en acier inox - roues  $\varnothing$  100 mm, dont deux avec frein. Paniers pas compris.

DE Korbwagen für Geschirrspülerkörbe. Edelstahl Boden - mit oder ohne Edelstahlgriff erhältlich - Mehrwegräder  $\varnothing$  100 mm, davon 2 mit Bremse, Körbe nicht enthalten.

IT Carrelli portacestelli per lavastoviglie. Vasca in ABS - disponibile con o senza manico in acciaio inox - ruote multidirezionali  $\varnothing$  100 mm di cui due con freno. Ceste non incluse.

EN Dishwasher basket trolleys. ABS base - available with or without stainless steel handle - multidirectional wheels  $\varnothing$  100 mm, 2 of which fixed. Baskets not included.

FR Chariots porte-paniers pour lave-vaisselle. Fond en ABS - disponible avec ou sans poignée en acier inox - roues  $\varnothing$  100 mm, dont deux avec frein. Paniers pas compris.

DE Korbwagen für Geschirrspülerkörbe. ABS-Boden - mit oder ohne Edelstahlgriff erhältlich - Mehrwegräder  $\varnothing$  100 mm, davon 2 mit Bremse, Körbe nicht enthalten.

	CP1445 con manico/with handle	CP1446 senza manico/without handle
	52 x 58 x 96(h) cm	52 x 52 x 20(h) cm
	60 Kg	
	270 €	240 €

	CP1447 con manico/with handle	CP1448 senza manico/without handle
	53 x 56 x 92(h) cm	53 x 56 x 21(h) cm
	50 Kg	
	140 €	100 €

# CB1444

# CB1443



# CB1449



- IT** Carrelli per impasti pizza con cassette da 60x40 cm - interamente in acciaio inox - disponibile con o senza manico in acciaio inox - ruote multidirezionali  $\varnothing$  100 mm di cui due con freno.
- EN** Pizza dough trolleys with 60x40 cm containers - entirely made of stainless steel - available with or without stainless steel handle - multidirectional wheels  $\varnothing$  100 mm, 2 of which fixed.
- FR** Chariots à pâte à pizza avec bacs de 60x40 cm - entièrement en acier inox - disponible avec ou sans poignée en acier inox - roues multidirectionnelles  $\varnothing$  100 mm, dont deux avec frein.
- DE** Pizzateigwagen mit 60x40 cm Behälter - komplett aus Edelstahl - mit oder ohne Edelstahlgriff erhältlich - Mehrwegräder  $\varnothing$  100 mm, davon 2 mit Bremse.

- IT** Carrello portacassette per impasti pizza 60x40 cm - senza manico - vasca in ABS - ruote multidirezionali  $\varnothing$  100 mm.
- EN** Trolley for Pizza dough containers 60x40 cm - without handle - ABS base - multidirectional wheels  $\varnothing$  100 mm.
- FR** Chariot à bacs pour pâte à pizza 60x40 cm - sans poignée - fond en ABS - roues multidirectionnelles  $\varnothing$  100 mm.
- DE** Wagen für Pizzateigbehälter 60x40 cm - ohne Griff - ABS-Boden - Mehrwegräder  $\varnothing$  100 mm.

	CB1444 con manico/with handle	CB1443 senza manico/without handle
	72 x 42 x 96(h) cm	62 x 42 x 20(h) cm
	50 Kg	
	270 €	240 €

	CB1449
	62 x 42 x 16,5(h) cm
	50 Kg
	80 €

Carrelli portacassette per impasti pizza  
Trolley for pizza dough container

# OPTIONAL





ACLAVCTSUP35





ACLAVCTSUP40



BV

	ACLAVCQ35	ACLAVCQ40	BV	ACLAVCT35	ACLAVCT40	ACLAVCTSUP35	ACLAVCTSUP40
	Cesto quadrato Square basket			Cesto tondo Round basket		Supporto per cesto tondo Round basket holder	
	35 x 35 x 15(h) cm	40 x 40 x 13(h) cm	50 x 50 x 10,6(h) cm	Ø 35 x 16(h) cm	Ø 40 x 18(h) cm	35 x 35 cm	40 x 40 cm
	18 €	18 €	22 €	18 €	18 €	35 €	35 €

	RIA9	RIA16	RIA25	RIA36	RIA49	RIAU	COPCEST
	Rialzo bicchieri con separatori compresi - Extender for glasses with spacers Prolonge pour verres avec séparateurs inclus - Gläser-Aufsatz mit trennwände					Rialzo universale adatto all'inserimento di separatori Universal extender possibility of insertion of dividers	Coperchio universale Universal cover
	Separatore / Compartment divider Séparateur compartiments / Trennwand Fächer						
	n. 9	n. 16	n. 25	n. 36	n. 49		
	max Ø 15 cm	max Ø 11 cm	max Ø 8,9 cm	max Ø 7,3 cm	max Ø 6,2 cm		
	50 x 50 x 5(h) cm					50 x 50 x 5(h) cm	50 x 50 x 2,5(h) cm
	13 €	13 €	13 €	14 €	14 €	12 €	17 €

# OPTIONAL



ACLAVCQ35



ACLAVCQ40



ACLAVCT40



ACLAVCT35



ACLAVPPOS



CP8



BP



BVM



B9

	ACLAVPPOS	CP8	BP	BA	BVM
	Inserto porta posate quadrato Square cutlery holder insert	Inserto porta posate 8 scomparti 8 compartment cutlery holder insert	Base piatti - 18 piani - 12 fondi Dishes rack 18 Dinner plates - 12 soup plates	Base vassoi - 9 vassoi Trays rack - 9 trays	Base posate Cutlery rack
	11,3 x 11,3 x 8,9(h) cm	43 x 20 x 10(h) cm	50 x 50 x 10,6(h) cm		
	5 €	16 €	24 €	22 €	25 €

	B9	B16	B25	B36	B49
	Base per bicchieri con separatori compresi - Glasses base with spacers Support pour verres avec séparateurs - Gläserkorb mit trennwände				
	Separatore / Compartment divider / Séparateur compartiments / Trennwand Fächer				
	n. 9	n. 16	n. 25	n. 36	n. 49
	max Ø 15 cm	max Ø 11 cm	max Ø 8,9 cm	max Ø 7,3 cm	max Ø 6,2 cm
	25 €	26 €	28 €	29 €	32 €



# Carrelli e articoli per il servizio in camera

TROLLEYS AND EQUIPMENT  
FOR ROOM SERVICE  
CHARIOTS ET ARTICLES  
DE ROOM SERVICE  
WAGEN UND AUSRÜSTUNG  
FÜR DEN ZIMMERSERVICE

## CB980



Esclusa cassetta  
Boxes not included

IT Carrelli per la colazione. Struttura portante in tubo di acciaio inox - ripiano con antine ribaltabili in nobilitato - ripiano di servizio ruotabile sino a 90°, con possibilità di incastrare i carrelli uno dentro l'altro per ridurre al minimo l'ingombro. Ruote multidirezionali di cui 2 con freno.

EN Breakfast trolleys. Supporting structure in stainless steel tube - shelf with melamine folding doors - service shelf that can be rotated up to 90°, trolleys can be pushed one inside the other to reduce the overall dimensions considerably. Multidirectional wheels, 2 with brake.

## CB970



FR Chariots pour le petit déjeuner. Structure portante en tube d'acier inox - plan de travail avec volets en mélaminé - plan de service pivotant jusqu'à 90°, les chariots peuvent être rangés les uns dans les autres pour réduire l'encombrement au minimum. Roues multidirectionnelles, dont 2 avec frein.

DE Frühstückswagen. Tragstruktur aus Edelstahlrohr - Abstellfläche mit Klapptüren aus Melamin - bis zu 90° drehbare Ablagefläche, Wagen ineinander stapelbar, um die Außenmaße höchst möglichst zu reduzieren. Mehrwegräder, davon 2 mit Bremse.

	CB980 noce-walnut	CB980CA carbon
	Open ø 80 x 80(h) cm Closed 80 x 53 x 80(h) cm	
	520 €	

	CB970 noce-walnut	CB970CA carbon
	Open 80 x 53 x 80(h) cm Closed 35 x 53 x 80(h) cm	
	520 €	

Carrelli per la colazione  
Breakfast trolleys

## CST300



CST300

- IT Cassetta termica per scaldare piatti e prime colazioni. Contenitore interamente in acciaio inox - piano intermedio - termostato regolabile.
- EN Heating box to warm plates and breakfasts. Container entirely in stainless steel - intermediate shelf - adjustable thermostat.
- FR Boîte thermique pour réchauffer les assiettes et les petits déjeuners. Corps entièrement en acier inox - étagère intermédiaire - thermostat réglable.
- DE Wärmekiste zum Erwärmen von Teller und Frühstück. Kiste komplett aus Edelstahl - Zwischenboden - einstellbarer Thermostat.

	CST300
	250 W
	230V/1N/50-60 Hz
	+30° +60°C
	39 x 37 x 46(h) cm - n.2 piatti/plates ø 33 cm
	340 €

## CPC600



Cassette termiche non incluse  
Boxes not included

CPC600

- IT Carrello porta cassette termiche Mod. CST300 con allacciamento elettrico. Struttura tubolare 25x25 mm in acciaio inox - guide per contenere n.6 cassette termiche. Ruote ø 125 mm di cui 2 con freno. Cassette non incluse.
- EN Heating boxes trolley Mod. CST300 with electrical connection. Tubular structure 25x25 mm in stainless steel - slides to store 6 heating boxes. Wheels ø 125 mm 2 of which with brake. Boxes not included.
- FR Chariot à boîtes thermiques Mod. CST300 avec connexion électrique. Structure en tube d'acier inox 25x25 mm - glissières pour contenir 6 boîtes thermiques. Roues ø 125 mm dont 2 avec frein. Boîte pas compris.
- DE Wagen für Wärmekiste Mod. CST300 mit elektrischem Anschluss. Rohrstruktur 25x25 mm aus Edelstahl - Führungen für 6 Wärmekisten. Räder ø 125 mm davon 2 mit Bremse. Wärmekisten nicht enthalten.

	CPC600
	230V/1N/50-60 Hz
	155 x 61 x 132(h) cm - ø 33 cm piatti/plates
	550 €

PV4064R

PV4064

PV4056R

PV4056



PV4064R



PV4064



PV4056R





PV4056

IT Carrelli portavaligie e portabiti. Base in legno ricoperta da moquette colorata, disponibile nei colori rosso o blu - supporto asta in tubolare di acciaio cromato da  $\varnothing$  40 mm - bordo paracolpi perimetrale in gomma - ruote pneumatiche  $\varnothing$  200 mm, di cui 2 fisse e 2 girevoli con freno.

EN Luggage trolleys and clothes racks. Wooden base covered with coloured carpet, available in red or blue - rod support in chrome-plated steel tube  $\varnothing$  40 mm - perimeter rubber shock absorber - pneumatic wheels  $\varnothing$  200 mm, 2 fixed and 2 swivelling with brake.

FR Chariots à bagages et porte-vêtements. Base en bois recouverte de moquette, disponible en rouge ou bleu - support en tube d'acier tubulaire chromé  $\varnothing$  40 mm - bord de butoir périphérique en caoutchouc - roues pneumatiques  $\varnothing$  200 mm, dont 2 fixes et 2 pivotantes avec frein.

DE Kofferwagen und Kleiderständer. Holzboden mit buntem Teppichboden, erhältlich in den Blau - Stabhalterung aus vermessingt oder verchromtem Stahlrohr  $\varnothing$  40 mm - Gummistoßschutz - Lufträder  $\varnothing$  200 mm, davon 2 fest und 2 drehbar mit Bremsen.

	PV4064R	PV4064	PV4056R	PV4056
				
	95 x 55 x 190(h) cm		95 x 55 x 183(h) cm	
	Base rossa + Struttura cromata Red base + Chromed structure	Base blu + Struttura cromata Blue base + Chromed structure	Base rossa + Struttura cromata Red base + Chromed structure	Base blu + Struttura cromata Blue base + Chromed structure
	150 Kg		150 Kg	
	1.265 €		1.045 €	

Carrelli portavaligie e portabiti  
Luggage trolleys and clothes racks

PV2001

PV2001I



WARNING

PV2021

PV2021I



IT Carrelli portavaligie e portabiti. Base in legno ricoperta da moquette colorata, disponibile in rosso - supporto asta in tubolare di acciaio ottonato o inox da  $\varnothing$  40 mm - bordo paracolpi perimetrale in gomma - ruote  $\varnothing$  200 mm, di cui 2 fisse e 2 girevoli.

EN Luggage trolleys and clothes racks. Wooden base covered with coloured carpet, available in red - rod support in brass-plated steel or stainless steel tube  $\varnothing$  40 mm - perimeter rubber shock absorber - wheels  $\varnothing$  200 mm, of which 2 fixed and 2 swivelling.

FR Chariots à bagages et porte-vêtements. Base en bois recouverte de moquette, disponible en rouge - support en tube d'acier tubulaire en laiton ou acier inox  $\varnothing$  40 mm - bord de butoir périphérique en caoutchouc - roues de  $\varnothing$  200 mm, dont 2 fixes et 2 pivotantes.

DE Chariots à bagages et porte-vêtements. Base en bois recouverte de moquette, disponible en rouge - support en tube d'acier tubulaire en laiton ou acier inox  $\varnothing$  40 mm - bord de butoir périphérique en caoutchouc - räder  $\varnothing$  220 mm, davon 2 fest und 2 drehbar.

IT Carrelli portavaligie e portabiti. Base in legno ricoperta da moquette colorata, disponibile nei colori rosso o nera - supporto asta in tubolare di acciaio ottonato o inox da  $\varnothing$  40 mm - bordo paracolpi perimetrale in gomma - ruote pneumatiche  $\varnothing$  225 mm, di cui 2 fisse e 2 girevoli con freno.

EN Luggage trolleys and clothes racks. Wooden base covered with coloured carpet, available in red or black - rod support in brass-plated steel or stainless steel tube  $\varnothing$  40 mm - perimeter rubber shock absorber - pneumatic wheels  $\varnothing$  225 mm, 2 fixed and 2 swivelling with brake.

FR Chariots à bagages et porte-vêtements. Base en bois recouverte de moquette, disponible en rouge ou noir - support en tube d'acier tubulaire en laiton ou acier inox  $\varnothing$  40 mm - bord de butoir périphérique en caoutchouc - roues pneumatiques  $\varnothing$  225 mm, dont 2 fixes et 2 pivotantes avec frein.

DE Kofferwagen und Kleiderständer. Holzboden mit buntem Teppichboden, erhältlich in den Farben Rot oder Schwarz - Stabhalterung aus vermessingt Stahl oder Edelstahlrohr  $\varnothing$  40 mm - Gummistoßschutz - Lufträder  $\varnothing$  225 mm, davon 2 fest und 2 drehbar mit Bremsen.

i	PV2001	PV2001I
cm	124 x 64 x 190(h) cm	
	Base rossa + Struttura ottone Red base + Brass structure	Base rossa + Struttura inox Red base + Stainless steel structure
MAX Kg	150 Kg	
	1.140 €	1.050 €

i	PV2021	PV2021I
cm	110 x 62 x 198(h) cm	
	Base rossa + Struttura ottone Red base + Brass structure	Base nero + Struttura inox Black base + Stainless steel structure
MAX Kg	150 Kg	
	1.110 €	995 €

124 Carrelli portavaligie e portabiti  
Luggage trolleys and clothes racks



IL CARRELLO VIENE SPEDITO IN KIT SMONTATO  
THE TROLLEY IS DELIVERED DISMOUNTED  
LE CHEROIT EST LIVRÉ DEMONTÉ  
DER WAGEN IST DEMONTIERT GELIEFERT

PV2002

PV2002I

PV2003

PV2003I





IT Carrelli portavaligie. Base pieghevole e piani in legno ricoperti di moquette colorata rossa - struttura disponibile in acciaio ottonato o inox - 2 piedi di appoggio - ruote  $\varnothing$  250 mm.

EN Luggage trolleys. Foldable base and wooden shelves covered with red carpet - structure available in brass or stainless steel - 2 support feet - wheels  $\varnothing$  250 mm.

FR Chariot à bagages. Base repliable et étagères en bois recouvertes de moquette de couleur rouge - structure disponible en acier laitoné ou en acier inox - 2 pieds de support - roues  $\varnothing$  250 mm.

DE Kofferwagen. Klappboden und Holzabstellflächen mit rotem Teppichboden - Struktur wahlweise aus vermessingtem Stahl oder Edelstahl - 2 Standfüße - Räder  $\varnothing$  250 mm.

	PV2002	PV2002I	PV2003	PV2003I
				
	56 x 83 x 123(h) cm		56 x 70 x 120(h) cm	
	Base rossa + Struttura ottone Red base + Brass structure	Base rossa + Struttura inox Red base + Stainless steel structure	Base rossa + Struttura ottone Red base + Brass structure	Base rossa + Struttura inox Red base + Stainless steel structure
	100 Kg		100 Kg	
	315 €	280 €	250 €	225 €

Carrelli portavaligie  
Luggage trolleys

## PVI4024



PVI4024

- IT Carrello portavaligie e portabiti. Struttura in tubo di acciaio inox - base in lamiera d'acciaio inox - ruote multidirezionali  $\varnothing$  140 mm, di cui 2 fisse.
- EN Luggage trolley and clothes rack Structure in stainless steel tube - base in stainless steel plate - multidirectional wheels  $\varnothing$  140 mm, 2 of which fixed.
- FR Chariots à bagages et porte-vêtements. Structure en tube d'acier inox - base en tôle d'acier inox - roues multidirectionnelles  $\varnothing$  140 mm, dont 2 fixes.
- DE Kofferwagen und Kleiderständer. Struktur aus Edelstahlrohr - Boden aus Edelstahlblech - Mehrwegräder  $\varnothing$  140 mm, 2 davon fest.

## ST4060

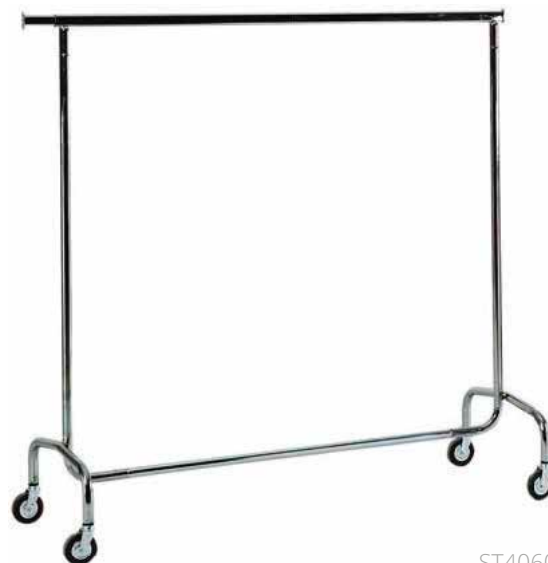

ST4060

- IT Stender portabiti. Struttura in tubo di acciaio cromato - asta allungabile di 30 cm per lato - ruote multidirezionali.
- EN Clothes rack. Chrome-plated steel tube structure - rod can be extended by 30 cm on each side - multidirectional wheels.
- FR Vêtements rack. Structure en tube d'acier chromé - bras extensible de 30 cm de chaque côté - roues multidirectionnelles.
- DE Kleiderständer. Verchromte Stahlrohrstruktur - der Stab lässt sich auf jeder Seite um 30 cm verlängern - Mehrwegräder.

	PVI4024
	100 x 56 x 160(h) cm
	200 Kg
	410 €

	ST4060
	Open 210 x 53 x 152(h) cm Closed 150 x 53 x 152(h) cm
	150 Kg
	110 €

## CPB1472



CPB1472

IT Carrelli per trasporto pesante. Pianale basso in lamiera di acciaio inox - manico smontabile - ruote multidirezionali ø 140 mm di cui 2 fisse e 2 girevoli con freno.

EN Trolleys for heavy transport Lower platform in stainless steel plate - removable handle - multidirectional wheels ø 140 mm, 2 of which fixed and 2 swivelling with brake.

## CPB1474



CPB1474

FR Chariot de transport lourd. Etagère basse en tôle d'acier inox - poignée amovible - roues multidirectionnelles ø 140 mm, dont 2 fixes et 2 pivotantes avec frein.

DE Wagen für den Schwertransport. Niedrige Ladefläche aus Edelstahlblech - abnehmbarer Griff - Mehrwegräder ø 140 mm, davon 2 fest und 2 drehbar mit Bremsen.

	CPB1472
	61 x 110 x 85(h) cm
	2 manici / handles
	200 Kg
	390 €

	CPB1474
	61 x 122 x 90(h) cm
	1 manico / handle
	200 Kg
	410 €

Carrelli per trasporto pesante  
Trolleys for heavy transport

## AC5118

- IT Aste delimita corsie per cordoni a treccia. Puntali in abbinamento.  
 EN Barriers posts for plaited cords. Matching caps.  
 FR Délimiteur de zone pour cordons tressés. Pointe coordonnée.  
 DE Begrenzungspfosten für geflochtene Seile. Passende Spitzen.



AC5118I

AC5118D

	AC5118D	AC5118I
	Asta dorata Golden post	Asta acciaio lucido Polished steel post
	90(h) cm	
	90 €	90 €

## CO4099



CO4099

- IT Cordone per aste. Colori: bordeaux, oro, verde, blu.  
 EN Barriers cord. Colours: burgundy, gold, green, blue.  
 FR Cordon pour délimiteur. Couleurs: bordeaux, or, vert, bleu.  
 DE Begrenzungsseile. Farben: Burgunder, Gold, Grün, Blau.

	CO4099B Blu-Blue	CO4099G Verde-Green	CO4099R Bordeaux	CO4099Y Oro-Gold
	ø 3 cm			
	40 € al metro/meter			

## PU5144



PU5144D

PU5144I

- IT Puntali in abbinamento delle aste delimita corsie per cordoni a treccia.  
 EN Caps matching the posts of the barriers with plaited cords.  
 FR Pointes coordonnées avec les mâts pour cordons tressés.  
 DE Spitzen passend zu den Begrenzungspfosten für geflochtene Seile.

	PU5144D	PU5144I
	Puntale dorato Gold cap	Puntale acciaio lucido Polished steel cap
	25 €	

## GA5144



GA5144D

GA5144I

- IT Gancio a muro, disponibile in colore dorato o cromato.  
 EN Wall ring, available in gold or chrome colour.  
 FR Anneau à mur, disponible en couleur or ou chromé.  
 DE Wandhaken, erhältlich in Gold oder verchromter Farbe.

	GA5144D	GA5144I
	Gancio dorato Gold wall ring	Gancio inox Stainless steel wall ring
	22 €	

# ACF5190



ACF5190

- IT** Aste delimita corsie. Disponibili in diverse misure con nastro avvolgibile colorato rosso o blu - asta colore oro, acciaio inox o nera. Puntali in abbinamento.
- EN** Retractable barriers available in different sizes with red or blue colored retractable belts - gold, stainless steel or black post. Matching caps.
- FR** Délimiteur de zone. Disponible en différentes tailles avec ruban roulant de couleur rouge ou bleue - mât en or, acier inox ou noir. Pointe coordonnée.
- DE** Begrenzungspfosten. Erhältlich in verschiedenen Größen mit rotem oder blauem Aufrollband - Gold, Edelstahl oder schwarze Pfosten. Passende Spitzen.

# PU5195



NERO/BLACK



ORO/GOLD



ACCIAIO  
STEEL

- IT** Puntali in abbinamento delle aste delimita corsie a seconda del colore e materiale scelto.
- EN** Caps matching the posts of the retractable barriers according to the colour and material chosen.
- FR** Pointes coordonnées avec les mâts de délimitation des voies en fonction de la couleur et du matériau choisi.
- DE** Spitzen passend zu den Begrenzungspfosten je nach Farbe und Material.

	ACF5190DB Blu-Blue	ACF5190DR Rosso-Red	ACF5190IB Blu-Blue	ACF5190IR Rosso-Red	ACF5190NB Blu-Blue	ACF5190NR Rosso-Red
	Asta dorata / Golden post		Asta acciaio lucido / Polished steel post		Asta nera / Black post	
	200 cm					
	90 €		90 €		90 €	

	PU5195DB Blu-Blue	PU5195DR Rosso-Red	PU5195IB Blu-Blue	PU5195IR Rosso-Red	PU5195NB Blu-Blue	PU5195NR Rosso-Red
	Puntale dorato Gold cap		Puntale acciaio lucido Polished steel cap		Puntale nero Black cap	
	40 €		40 €		40 €	

Aste delimita corsia  
Retractable barriers



# Carrelli portabiancheria

refornimento frigobar, pulizia e multiuso

LAUNDRY, MINIBAR, CLEANING  
AND MULTI-PURPOSE TROLLEYS.  
CHARIOTS À LINGE, REEMPLISSAGE MINIBAR,  
NETTOYAGE ET POLYVALENT.  
WÄSCHEREI-, MINIBAR-, REINIGUNGS-  
UND MEHRZWECKWAGEN.

# CA1505



CA1505

# CA1510



CA1510CA

# CA1515



CA1515







**IT** Carrelli portabiancheria. Struttura in acciaio inox - piani in laminato - in dotazione un sacco in tessuto ignifugo - paracolpi in gomma - ruote multidirezionali ø 125 mm.

**EN** Laundry trolleys. Stainless steel structure - laminate shelves - fireproof fabric bag included - rubber shock absorbers - multidirectional wheels ø 125 mm.

**FR** Chariots à linge. Structure en acier inox - dessus en stratifié - sac en tissu ignifuge inclus - butoir en caoutchouc - roues multidirectionnelles ø 125 mm.

**DE** Wäschereiwagen. Edelstahlstruktur - Laminatoberflächen - feuerfester Gewebesack inbegriffen - Gummistoßschutz - Mehrwegräder ø 125 mm.

	CA1505 noce-walnut	CA1505CA carbon	CA1510 noce-walnut	CA1510CA carbon	CA1515 noce-walnut	CA1515CA carbon	A520	A515
	70/100 x 50 x 123(h) cm		90/143 x 50 x 123(h) cm		110/143 x 50 x 123(h) cm		Sacco in tela ignifugo Fireproof fabric bag Sac en tissu ignifugé Feuerfester Gewebesack	Ruote con freno Wheels with brake Roues avec frein Räder mit Bremsen
	4							
	1 braccio pieghevole / folding arm		2 braccia pieghevoli / folding arms				37 x 31 x 80(h) cm	
	645 €		670 €		680 €		75 €	18 € cad./each

Carrelli portabiancheria  
Laundry trolleys

# CA1525



CA1525

- IT** Carrello portabiancheria. Struttura in acciaio inox - piani in acciaio inox - 2 portasacchi, in dotazione un sacco in tessuto ignifugo - cassetto superiore porta accessori in acciaio inox - paracolpi in gomma - ruote multidirezionali  $\varnothing$  125 mm.
- EN** Laundry trolley. Stainless steel structure - stainless steel shelves - 2 bag holders, supplied with a fireproof fabric bag - stainless steel upper drawer for accessories - rubber shock absorber - multidirectional wheels  $\varnothing$  125 mm.
- FR** Chariot à linge. Structure en acier inox - étagères en acier inox - 2 porte-sacs, fournis avec un sac en tissu ignifugé - tiroir supérieur porte-accessoires en acier inox - butoir en caoutchouc - roues multidirectionnelles  $\varnothing$  125 mm.
- DE** Wäschereiwagen. Edelstahlstruktur - Edelstahloberflächen - 2 Sackhalter, feuerfester Gewebesack inbegriffen - obere Schublade aus Edelstahl für Zubehörteile - Gummistoßschutz - Mehrwegräder  $\varnothing$  125 mm.

# CA1530



CA1530

- IT** Carrello portabiancheria, pulizia e multiuso. Struttura in lamiera verniciata a polveri epossidiche - 2 portasacchi, in dotazione un sacco in tessuto ignifugo - vaschetta porta detersivi superiore - chiusura porta con chiave - ruote  $\varnothing$  140 mm, di cui 2 fisse e 2 girevoli.
- EN** Laundry, cleaning and multi-purpose trolley. Structure in epoxy powder coated sheet - 2 bag holders, supplied with a fireproof fabric bag - upper detergent tray - door lock with key - wheels  $\varnothing$  140 mm, 2 of which fixed and 2 swivelling.
- FR** Chariot à linge, nettoyage et polyvalent. Structure en tôle d'acier peinte avec des poudres époxydiques - 2 porte-sacs, fournis avec un sac en tissu ignifugé - plateau supérieur à détergent - serrure de porte avec clé - roues  $\varnothing$  140 mm, dont 2 fixes et 2 pivotantes.
- DE** Wäscherei-, Reinigungs- und Mehrzweckwagen. Struktur aus mit Epoxidpulvern beschichtetem Blech - 2 Sackhalter, feuerfester Gewebesack inbegriffen - obere Waschmittelablage - Türschloss mit Schlüssel - Räder  $\varnothing$  140 mm, davon 2 fest und 2 schwenkbar.

	CA1525 inox	A520	A515
	75/136 x 55 x 157,5(h) cm	Sacco in tela ignifugo Fireproof fabric bag Sac en tissu ignifugé	Ruote con freno Wheels with brake Roues avec frein Räder mit Bremsen
	4 piani / layers + cassetta / upper drawers	Feuerfester Gewebesack	
	2 braccia pieghevoli folding arms	37 x 31 x 80(h) cm	
	980 €	75 €	18 € cad./each

	CA1530	A520	A518
	80/153 x 50 x 158(h) cm	Sacco in tela ignifugo Fireproof fabric bag Sac en tissu ignifugé	Ruote con freno Wheels with brake Roues avec frein Räder mit Bremsen
	3 piani / layers + cassetta / upper drawers + 2 portasacchi / bag holders	Feuerfester Gewebesack	
	2 braccia pieghevoli folding arms	37 x 31 x 80(h) cm	
	900 €	75 €	22 € cad./each

## CR1696



CR1696

IT Carrello rifornimento frigo e multiuso. Struttura in lamiera verniciata a polveri epossidiche - vaschetta laterale per la raccolta dei vuoti, asportabile - chiusura porta con chiave - ruote ø 140 mm, di cui 2 fisse e 2 girevoli.

EN Multipurpose and mini bar filling trolley. Structure in epoxy powder coated plate - side tray for collecting dirt, removable - door lock with key - wheels ø 140 mm, of which 2 fixed and 2 swivelling.

FR Chariot pour le remplissage mini bar et polyvalent. Structure en tôle peinte à la poudre époxy - plateau latéral de vidange, démontable - serrure de porte avec clé - roues de ø 140 mm, dont 2 fixes et 2 pivotantes.

DE Minibar- und Mehrzweckwagen. Struktur aus mit Epoxidpulvern beschichtetem Blech - seitliche Ablage zum Entleeren, abnehmbar - Türschloss mit Schlüssel - Räder ø 140 mm, davon 2 fest und 2 drehbar.



A518

i	CR1696	A518
↗ cm	80 x 50 x 118(h) cm	Ruote con freno Wheels with brake Roues avec frein Räder mit Bremsen
N.	4 ripiani / shelves	
	700 €	22 € cad./each

Carrelli per rifornimento frigobar  
Trolleys for mini-bar refuelling

## CA3203



CA3203

IT Cestone portabiancheria pieghevole con sacco in tela e ruote multidirezionali.

EN Folding laundry basket with fabric bag and multidirectional wheels.

FR Sac à linge pliable avec sac en toile et roues multidirectionnelles.

DE Faltbarer Wäschekorb mit Gewebesack und Mehrwegräder.

i	CA3203	A525
↗ cm	62 x 64 x 100(h) cm	Sacco in tela - Fabric bag Sac de toile - Gewebesack
	-	50 x 58 x 78(h) cm
	200 €	50 €

Cestone per biancheria  
Laundry basket

# CA1580



CA1580

IT Carrello pieghevole plastificato. Ruote multidirezionali  $\varnothing$  80 mm.

EN Plastic-coated folding trolley. Multidirectional wheels  $\varnothing$  80 mm.

FR Chariot pliante plastifié. Roues multidirectionnelles  $\varnothing$  80 mm.

DE Faltbarer Kunststoffwäschekorb. Mehrwegräder  $\varnothing$  80 mm.

# CA1584



CA1584

IT Carrello pieghevole rinforzato con struttura tubolare  $\varnothing$  30 mm verniciato - ruote a forcella  $\varnothing$  100 mm.

EN Reinforced folding trolley with painted tubular structure  $\varnothing$  30 mm - fork wheels  $\varnothing$  100 mm.

FR Chariot pliant renforcé à structure tubulaire peinte  $\varnothing$  30 mm - roues à fourches  $\varnothing$  100 mm.

DE Verstärkter Klappwagen mit lackierter Rohrstruktur  $\varnothing$  30 mm - Gabelräder  $\varnothing$  100 mm.

	CA1580	A521
	80 x 51 x 72(h) cm	Sacco in cotone - Cotton bag Sac en coton - Sack aus Baumwolle 74 x 50 x 62/75(h) cm
	50 Kg	
	135 €	85 €

	CA1584	A531
	100 x 60 x 87(h) cm	Sacco in cotone - Cotton bag Sac en coton - Sack aus Baumwolle 90 x 60 x 70/82(h) cm
	70-80 Kg	
	360 €	110 €

## CA1599



CA1599

IT Secchio carrellato con strizzatore 15 L. Struttura di rialzo per inserimento prodotti pulizia - manico cromato ad incastro con impugnatura in gomma antiscivolo.

EN Bucket with wringer on wheels 15 L. Elevated structure for the insertion of cleaning products - chromed handle with non-slip rubber grip.

FR Seau sur roues avecessoreuse 15 L. Structure de rehausse pour l'insertion des produits de nettoyage - manche chromé avec poignée antiglisse en caoutchouc.

DE Fahrbarer Mopp Eimer mit Presse 15 L. Erhöhte Struktur für den Einsatz von Reinigungsmitteln - verchromter Griff mit rutschfestem Gummigriff.

## CA1599E



CA1599E

IT Secchio carrellato con strizzatore 32 L.

EN Bucket with wringer on wheels 32 L.

FR Seau sur roues avecessoreuse 32 L.

DE Fahrbarer Mopp Eimer mit Presse 32 L.

	CA1599
	55 x 27 x 87(h) cm
	180 €

	CA1599E
	60 x 40 x 92(h) cm
	80 €

Carrelli per pulizia  
Cleaning trolleys

## CA1604



CA1604



- IT Secchio carrellato con strizzatore in nylon - 2 secchi da 25 L - maniglione reversibile - ruote multidirezionali da  $\varnothing$  80 mm.
- EN Bucket with nylon wringer on wheels - 2x25 L buckets - reversible handle - multidirectional wheels  $\varnothing$  80 mm.
- FR Seau sur roue avecessoreuse en nylon - 2 seaux de 25 litres - poignée réversible - roues multidirectionnelles  $\varnothing$  80 mm.
- DE Fahrbarer Mopp Eimer mit Nylonpresse - 2x25 L. Eimer - Wendegriff - Mehrwegräder  $\varnothing$  80 mm.



## CA1604E



CA1604E

- IT Secchio carrellato con strizzatore in nylon - 2 secchi da 17 L - maniglione reversibile - ruote multidirezionali da  $\varnothing$  80 mm.
- EN Bucket with nylon wringer on wheels - 2x17 L buckets - reversible handle - multidirectional wheels  $\varnothing$  80 mm.
- FR Seau sur roue avecessoreuse en nylon - 2 seaux de 17 litres - poignée réversible - roues multidirectionnelles  $\varnothing$  80 mm.
- DE Fahrbarer Mopp Eimer mit Nylonpresse - 2x17 L. Eimer - Wendegriff - Mehrwegräder  $\varnothing$  80mm.

	CA1604
	87 x 42 x 90(h) cm
	215 €

	CA1604E
	71 x 43 x 93(h) cm
	100 €

## CA1613



CA1613

- IT** Carrello per pulizia. Telaio e impugnatura in plastica - secchio, strizzatore e cassette in plastica - strizzatore in plastica a libro senza fondo - portasacco da 100 L completo di rinforzi e coperchio - 2 secchielli da 4 L e 1 secchio da 28 L - gancio portapaletta e gancio portamanico con rullo in gomma.
- EN** Cleaning trolley Plastic frame and handle - plastic bucket, wringer and trays - plastic wringer without bottom - 100 L bag holder complete with reinforcements and lid - 2x4 L buckets and 1x28 L bucket - dustpan hook and handle hook with rubber roller.
- FR** Chariot pour le nettoyage. Corps et poignée en plastique - seau, essoreuse et bacs en plastique - essoreuse en plastique sans fond - porte-sac de 100 L. complet avec renforts et couvercle - 2 seaux de 4 L. et 1 seau de 28 L. - crochet pour palette et manche avec rouleau en caoutchouc.
- DE** Reinigungswagen. Kunststoffrahmen und -griff - Eimer, Presse und Behälter aus Kunststoff - Kunststoffpresse ohne Boden - 100 L. Sackhalterung komplett mit Verstärkungen und Deckel - 2x4 L. Eimer und 1x28 L. Eimer - Kehrblech- und Griffhaken mit Gummirolle.

## CA1614



CA1614

- IT** Carrello per pulizia. Telaio e impugnatura in plastica - secchio, strizzatore e cassetta in plastica media - portasacco - 2 secchielli da 4 L e 1 secchio da 15 L - ganci portascopo - ruote ø 100 mm. Il porta vaschette superiore incluso.
- EN** Cleaning trolley Plastic frame and handle - bucket, wringer and medium plastic tray - bag holder - 2 buckets of 4 L and 1 bucket of 15 L - broom hook - wheels ø 100 mm. The upper tray holder is included.
- FR** Chariot pour le nettoyage. Corps et poignée en plastique - seau, essoreuse et bac moyen en plastique moyenne - porte-sac - 2 seaux de 4 L. et 1 seau de 15 L. - crochets porte balai - roues ø 100 mm. Le porte bacs supérieur est inclus.
- DE** Reinigungswagen. Kunststoffrahmen und -griff - Eimer, Presse und mittelgroßer Behälter aus Kunststoff - Sackhalterung - 2x4 L. Eimer und 1x15 L. Eimer - Besenhaken - Räder ø 100 mm. Der obere Ablagefachhalter ist inbegriffen.

	CA1613
	107 x 55 x 111(h) cm
	430 €

	CA1614
	97 x 68 x 125(h) cm
	530 €

## CA1615



CA1615

- IT Carrello per la pulizia. Telaio e impugnatura in plastica - secchio, strizzatore e cassetta in plastica media - portasacco - 2 secchielli da 4 L e 2 secchi da 15 L - ganci portascopo - ruote  $\varnothing$  100 mm. Portavaschette superiore incluso.
- EN Cleaning trolley Plastic frame and handle - bucket, wringer and medium plastic tray - bag holder - 2x4 L buckets and 2x15 L buckets - broom hook - wheels  $\varnothing$  100 mm. The upper tray holder is included.
- FR Chariot pour le nettoyage. Corps et poignée en plastique - seau, essoreuse et bac moyen en plastique moyenne - porte-sac - 2 seaux de 4 L. et 2 seaux de 15 litres - crochets porte balai - roues  $\varnothing$  100 mm. Le port bacs supérieur est inclus.
- DE Reinigungswagen. Kunststoffrahmen und -griff - Eimer, Presse und mittelgroßer Behälter aus Kunststoff - Sackhalterung - 2x4 L. Eimer und 1x15 L. Eimer - Besenhaken - Räder  $\varnothing$  100 mm. Der obere Ablagefachhalter ist inbegriffen.

	CA1615
	92 x 68 x 124(h) cm
	550 €

## CA1616



WARNING

CA1616

- IT Carrello per la pulizia. Telaio e impugnatura in plastica - secchio, strizzatore e cassetta in plastica media - cestino portabottiglie portasacco - 4 secchielli da 4 L e 2 secchi da 15 L - ganci portascopo - vano centrale con cassetto scorrevole - ruote  $\varnothing$  100 mm. Coperchio superiore di colore blu non incluso nel prezzo.
- EN Cleaning trolley Plastic frame and handle - bucket, wringer and medium plastic tray - bottle rack - bag holder - 2x4 L buckets and 2x15 L buckets - broom hook - central compartment with sliding drawer - wheels  $\varnothing$  100 mm. Blue lid not included in the price.
- FR Chariot pour le nettoyage. Corps et poignée en plastique - seau, essoreuse et bac moyen en plastique moyenne - corbeille pour bouteilles, porte-sac - 4 seaux de 4 L. et 2 seaux de 15 litres - crochets porte balai - compartiment central avec tiroir coulissant - roues  $\varnothing$  100 mm. Couvercle supérieur bleu non compris dans le prix.
- DE Reinigungswagen. Kunststoffrahmen und -griff - Eimer, Presse und mittelgroßer Behälter aus Kunststoff - Flaschenkorb und Sackhalterung - 2x4 L. Eimer und 1x15 L. Eimer - Besenhaken - Mittelfach mit Schiebeschublade - Räder  $\varnothing$  100 mm. Blaue obere Abdeckung nicht im Preis inbegriffen.

	CA1616
	133 x 68 x 124(h) cm
	840 €



Foto con OPTIONAL: coperchio superiore non incluso  
Photos with OPTIONAL: lid not included  
Photo avec ACCESSOIRES: couvercle supérieur non compris  
Abgebildet mit ZUBEHÖR: Obere Abdeckung nicht im Preis inbegriffen.

## CA1606E



CA1606E

- IT Carrello per pulizia. Telaio e impugnatura in plastica - secchio con strizzatore in plastica - portasacco con sacco da 120 L - attacco porta utensili.
- EN Cleaning trolley Plastic frame and handle - bucket with plastic wringer - bag holder with 120 L bag - tool holder.
- FR Chariot pour le nettoyage. Corps et poignée en plastique - seau avecessoreuse en plastique - porte-sac avec sac de 120 L. - porte-outils.
- DE Reinigungswagen. Kunststoffrahmen und -griff - Eimer mit Kunststoffpresse - Sackhalterung mit 120 L. Sack - Werkzeughalteranschluss.

## CA1520



CA1520

- IT Carrello multiuso in plastica.
- EN Multi-purpose plastic trolley.
- FR Chariot en plastique polyvalent.
- DE Mehrzweckwagen aus Kunststoff.

	CA1606E
	114 x 51 x 98(h) cm
	230 €

	CA1520
	150 x 54 x 99(h) cm
	325 €

Carrelli per pulizia  
Cleaning trolleys

Carrello multiuso in plastica  
Multi-purpose plastic trolley



# Articoli vari per la macelleria

ITEMS FOR THE  
MEAT PROCESSING  
ARTICLES POUR LA  
TRANSFORMATION DE LA VIANDE  
ARTIKEL FÜR DIE FLEISCHVERARBEITUNG

## LMMC



LMMC

IT Combinato lavamani più lavastracci in acciaio inox AISI 304 con rubinetto acqua calda/fredda.

EN Stainless steel AISI 304 combi hand washer and rags washer with hot/cold water tap.

FR Lave-mains combiné en acier inox AISI 304 avec robinet d'eau chaude/froide.

DE Handwasch- & Ausgussbecken übereinanderliegend AISI 304 mit Heiß/Kaltwassermischer.

## LMM - LM48M



LMM



LM48M

IT Lavamani con mobile e comandi a ginocchio. Lavamani in acciaio inox AISI 304 su mobile con porte a battente - comando a ginocchio.

EN Hand washer on neutral element with knee lever. Stainless steel AISI 304 hand washer on cabinet with hinged doors - knee lever.

FR Lave-mains sur meuble neutre avec commande à genou. Lave-mains en acier inox AISI 304 sur meuble à portes battantes - commande à genou.

DE Handwaschbecken auf Schrank mit Kniehebel. Handwaschbecken AISI 304 auf Schrank mit Flügeltüren - Kniehebel.

	LMMC
	70 x 50 x 89(h) cm
	720 €

	LMM	LM48M
	50 x 40 x 85(h) cm	40 x 40 x 85(h) cm
	570 €	550 €

Lavamani  
Hand washer

## LC50MM



LC50MM

- IT Lavamani e lavautensili con mobile. Lavamani e utensili su mobile in acciaio inox AISI 304 - porta battente - miscelatore acqua calda/fredda vasca da 40x40x25(h) cm.
- EN Hand washer and tools washer on cabinet. Hand washer and tools washer on stainless steel AISI 304 cabinet - hinged door - hot / cold water tap, bowl 40x40x25(h) cm.
- FR Lave-mains et lave-outils sur meuble. Lave-mains et lave-outils sur meuble en acier inox AISI 304 - porte battante - robinet d'eau chaude / froide cuve 40x40x25(h) cm.
- DE Hand- und Werkzeugwaschbecken auf Schrank. Hand- und Werkzeugwaschbecken auf Edelstahlschrank AISI 304 - Flügeltür - 40x40x25(h) cm Heiß-/Kaltwassermischer.

## LC50



LC50

- IT Lavamani a colonna e comandi a ginocchio. Struttura in acciaio inox AISI 304.
- EN Pillar hand washer with knee lever. Stainless steel AISI 304 structure.
- FR Colonne lave-mains avec commandes à genou. Structure en acier inox AISI 304.
- DE Säulenhandwaschbecken mit Kniehebel. Edelstahlstruktur AISI 304.

	LC50MM
	50 x 50 x 85(h) cm
	720 €

	LC50
	50 x 40 x 80(h) cm
	390 €

## LM40

## LM48



LM40



LM48

IT Lavamani a colonna e comandi a ginocchio. Struttura in acciaio inox AISI 304.

EN Pillar hand washer with knee lever. Stainless steel AISI 304 structure.

FR Colonne lave-mains avec commandes à genou. Structure en acier inox AISI 304.

DE Säulenhandwaschbecken mit Kniehebel. Edelstahlstruktur AISI 304.

	LM40	LM48
	40 x 40 x 28(h) cm	48 x 35 x 53(h) cm
	275 €	375 €

Lavamani  
Hand washer

## AV4898

IT Grebiule acciaio inox antinfortunistico con bretelle.

EN Stainless steel safety apron with shoulder straps.

FR Tablier de sécurité en acier inox avec sangles d'épaule.

DE Edelstahl-Sicherheitsschürze mit Schultergurten.

	AV4898
	230 €



## AV4900

IT Guanto inox antinfortunistico a cinque dita con cinturino inox completamente sterilizzabile.

EN Five-finger stainless steel safety glove with stainless steel strap, fully sterilisable.

FR Gant de sécurité à cinq doigts en acier inox avec sangle en acier inox, entièrement stérilisable.

DE Edelstahl-Fünf-Finger-Sicherheitshandschuh mit Edelstahlband völlig sterilisierbar.

	AV4900
	170 €



## AV4901

IT Guanto inox antinfortunistico a cinque dita con chiusura a molla inox. Avambraccio compreso.

EN Stainless steel five finger safety glove with stainless steel spring fastening. Forearm included.

FR Gant de sécurité à cinq doigts en acier inox avec fermeture à ressort en acier inox. Avant-bras inclus.

DE Edelstahl-Fünf-Finger-Sicherheitshandschuh mit Edelstahl-Feder-Verschluss. Unterarm inklusive.

	AV4901
	300 €



Grebiuli e guanti  
Aprons and gloves

## SUVN



SUVN

## SUVN2P







SUVN2P

IT Armadietto sterilizzatore universale a raggi UV costruito in acciaio inox. Adatto per utensilerie varie - funzionamento con lampada germicida con griglia di protezione - portina in plexiglas trasparente con microinterruttore - temporizzatore 60' e lampada spia di funzionamento - cavo con spina. Disponibili ad uno o due scomparti.

EN Universal UV steriliser cabinet made of stainless steel. Ideal for various tools - germicidal lamp operation with protection grid - clear Plexiglas door with microswitch - 60' timer and indicator lamp - cable with plug. Available with one or two compartments.

FR Armoire stérilisateur UV universelle en acier inox. Indiqué pour divers ustensiles - fonctionnement avec lampe germicide avec grille de protection - porte en plexiglas transparent avec microinterrupteur - minuteur 60' et indicateur lumineux de fonctionnement - câble avec fiche. Disponible avec une ou deux compartiment.

DE UV-Sterilisationsschrank aus Edelstahl. Geeignet für verschiedene Utensilien - Funktionsweise mit keimtötender Lampe mit Schutzgitter - klare Plexiglastür mit Mikroschalter - 60'-Timer und Anzeigelampe - Kabel mit Stecker. Erhältlich mit einem oder zwei Einlegeböden.

	SUVN	SUVN2P
		
	16 W	16 W + 16 W
 1 Ph	230V/1N/50-60 Hz	
	51 x 28 x 35(h) cm	51 x 28 x 70(h) cm
	400 €	750 €

## SUV10



SUV10

## SUV14







SUV14

IT Armadietto sterilizzatore a raggi UV costruito in acciaio inox. Portina in plexiglas trasparente con microinterruttore - portacoltelli in acciaio inox - funzionamento con lampada germicida con griglia di protezione temporizzatore 60' e lampada spia di funzionamento - cavo con spina.

EN UV sterilizer cabinet made of stainless steel. Clear Plexiglas door with microswitch - stainless steel knife holder - operation with germicidal lamp with 60' timer protection grid and indicator lamp - cable with plug.

FR Armoire stérilisateur UV en acier inox. Porte en plexiglas transparent avec microinterruteur - porte-couteau en acier inox - fonctionnement avec lampe germicide avec grille de protection, minuteur 60' et indicateur lumineux - câble avec fiche.

DE UV-Sterilisationsschrank aus Edelstahl. Tür aus klarem Plexiglas mit Mikroschalter - Messerhalter aus Edelstahl - Betrieb mit Keimtöterlampe mit 60' Timer, Schutzgitter und Anzeigelampe - Kabel mit Stecker.

	SUV10	SUV14
		
	16 W	
 1 Ph	230V/1N/50-60 Hz	
	N° 10 coltelli / knives	N° 14 coltelli / knives
 cm	43 x 16 x 64(h) cm	54 x 16 x 64(h) cm
	330 €	370 €

# CCL

IT Ceppo in legno di acacia e sgabello. Ceppo trattato con vernice atossica e collanti ecologici (conformi alle norme vigenti) assemblato con innesti a pressione e internamente con inserti speciali in legno - batticarne ecologico e riciclabile - reversibile.

EN Acacia wood chopping block and stool. Chopping block treated with non-toxic paint and ecological adhesives (in compliance with current standards) assembled with pressure joints and internally with special wood inserts - ecological and recyclable meat beater - reversible.

FR Blocs de boucher en bois d'acacia et tabouret. Bloc traité avec peinture atoxique et adhésifs écologiques (conformes aux normes en vigueur) assemblés avec embrayages à pression et intérieur avec inserts spéciaux en bois - bloc à viande écologique et recyclable - réversible.

DE Metzger-Block aus Akazienholz und Hocker. Metzger-Block behandelt mit ungiftiger Farbe und ökologischen Klebstoffen (nach den gültigen Normen), zusammengebaut mit Steckverbindungen und speziellen innen Holzeinsätzen - umweltfreundlicher und wiederverwertbarer Fleischklopfer - beidseitig.



CCL

	CCL1744	CCL1745	CCL1755	CCL1764	CCL1766	CCL1774	CCL1775
	40 x 40 x 90(h) cm	45 x 45 x 90(h) cm	50 x 50 x 90(h) cm	60 x 40 x 90(h) cm	60 x 60 x 90(h) cm	70 x 40 x 90(h) cm	70 x 50 x 90(h) cm
	590 €	655 €	765 €	765 €	1.020 €	850 €	1.020 €



SPESSORE / THICKNESS 17 cm

	CCL2544	CCL2555	CCL2564	CCL2566	CCL2574	CCL2575	CCL2577
	40 x 40 x 90(h) cm	50 x 50 x 90(h) cm	60 x 40 x 90(h) cm	60 x 60 x 90(h) cm	70 x 40 x 90(h) cm	70 x 50 x 90(h) cm	70 x 70 x 90(h) cm
	740 €	950 €	950 €	1.170 €	1.010 €	1.170 €	1.390 €



SPESSORE / THICKNESS 25 cm

	CCL3555	CCL3566	CCL3575	CCL3577	CCL3586
	50 x 50 x 90(h) cm	60 x 60 x 90(h) cm	70 x 50 x 90(h) cm	70 x 70 x 90(h) cm	80 x 60 x 90(h) cm
	1.170 €	1.455 €	1.455 €	1.805 €	1.805 €



SPESSORE / THICKNESS 35 cm

# CCP



IT Ceppo in polietilene e sgabello in acciaio inox AISI 304.

EN Polyethylene block and AISI 304 stainless steel stool.

FR Bloc en polyéthylène et tabouret en acier inox AISI 304.

DE Polyethylenblock und Hocker aus Edelstahl AISI 304.



CCP

# KCP - CPE



KCP  
COPRICEPPO / BLOCK COVER



CPE  
CEPPO / CHOPPING BLOCK

	CCP8000	CCP8001	CCP8002	CCP8003	CCP8004	CCP8005	CCP8006
	40 x 40 x 88(h) cm	50 x 50 x 88(h) cm	70 x 50 x 88(h) cm	60 x 60 x 88(h) cm	70 x 70 x 88(h) cm	80 x 60 x 88(h) cm	100 x 50 x 88(h) cm
	435 €	510 €	615 €	630 €	745 €	735 €	735 €

	KCP2501	KCP2502	KCP2503	KCP2504	KCP2505	KCP2506	KCP2508
Copriceppo di polietilene bianco - White polyethylene block cover - Couverture en polyéthylène blanc - Weiße Polyethylenabdeckung							
	40 x 40 x 1,5(h) cm	50 x 50 x 1,5(h) cm	60 x 40 x 1,5(h) cm	60 x 60 x 1,5(h) cm	70 x 40 x 1,5(h) cm	70 x 50 x 1,5(h) cm	70 x 70 x 1,5(h) cm
	100 €	145 €	140 €	190 €	150 €	185 €	255 €

	CPE40408	CPE50508	CPE70508	CPE60608	CPE70708	CPE80608	CPE100508
Ceppo di polietilene alimentare bianco - Chopping block made of white food grade polyethylene - Bloc en polyéthylène alimentaire - Polyethylenblock							
	40 x 40 x 8(h) cm	50 x 50 x 8(h) cm	70 x 50 x 8(h) cm	60 x 60 x 8(h) cm	70 x 70 x 8(h) cm	80 x 60 x 8(h) cm	100 x 50 x 8(h) cm
	170 €	245 €	320 €	350 €	455 €	445 €	445 €

Ceppi in polietilene  
Polyethylene blocks

# TP

IT Taglieri in polietilene.

EN Polyethylene cutting boards.

FR Planches à découper en polyéthylène.

DE Schneidebretter aus Polyethylen.



TP80402

	TP40302 bianco-white	TP50302 bianco-white	TP50402 bianco-white	TP60402 bianco-white	TP70402 bianco-white	TP80402 bianco-white
	40 x 30 x 2(h) cm	50 x 30 x 2(h) cm	50 x 40 x 2(h) cm	60 x 40 x 2(h) cm	70 x 40 x 2(h) cm	80 x 40 x 2(h) cm
	33 €	39 €	54 €	60 €	77 €	87 €



	TP50302B blu-blue	TP50302G verde-green	TP50302M marrone brown	TP50302R rosso-red	TP50302Y giallo-yellow
	50 x 30 x 2(h) cm				
	39 €				

	TP60402B blu-blue	TP60402G verde-green	TP60402M marrone brown	TP60402R rosso-red	TP60402Y giallo-yellow
	60 x 40 x 2(h) cm				
	60 €				

# RASK



RASK

IT Raschietto per pulizia ceppi e taglieri compreso di 4 lamette.

EN Scraper for butcher blocks and cutting boards cleaning including 4 blades.

FR Racloir pour le nettoyage des blocs et des planches à découper, incluant 4 lames.

DE Schaber zum Reinigen von Metzger-Blöcke und Schneidbrettern mit 4 Klingen.

	RASK
	45 €

# FT30

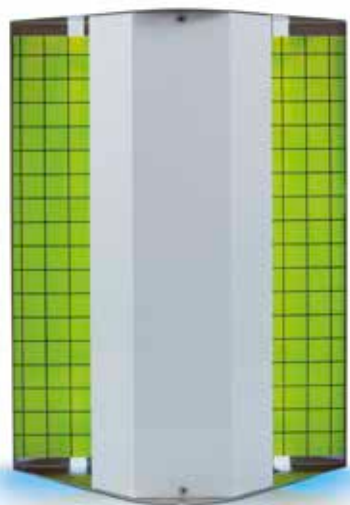

FT30

# PZ30N



PZ30N

IT Elettroinsetticidi a lampade UVA. Potenza 30W. Lampade 2x15W - possibilità di montaggio in orizzontale o verticale - copertura fino a 80 mq. Materiale: FT30 acciaio inox AISI 304; PZ30N alluminio.

FR Electro-insecticides avec lampes UVA. Puissance 30W. 2 Lampes 15W - possibilité de montage horizontal ou vertical - portée jusqu'à 80 m<sup>2</sup>. Matériel: FT30 acier inox AISI 304; aluminium PZ30N.

EN Electro-insecticides with UVA lamps. Power 30W. 2x15W lamps - horizontal or vertical installation - surface cover up to 80 sqm. Material: FT30 AISI 304 stainless steel - Aluminium PZ30N.

DE Elektroinsekt-Killer mit UVA-Lampen. Leistung 30W. 2x15W Lampen - horizontale oder vertikale Montage möglich - Reichweite bis zu 80 qm. Material: FT30 Edelstahl AISI 304; Aluminium PZ30N.



i	FT30	CR30	L617
↗ cm	48 x 36 x 16(h) cm	Collante di ricambio confezione da 6 pezzi Spare glue pack of 6 pieces - Colle de rechange 6 pièces Ersatzkleber 6 Stück-Packung	Lampada Lamp Lampe 15 W
	260 €	54 €	12 €

i	PZ30N	L617
↗ cm	55 x 11 x 26(h) cm	Lampada Lamp Lampe 15 W
	140 €	12 €

Elettroinsetticidi  
Electro-insecticides

# SCAFFALATURA MODULARE

MODULAR SHELVING  
RAYONNAGE MODULAIRE  
MODULARE REGALE

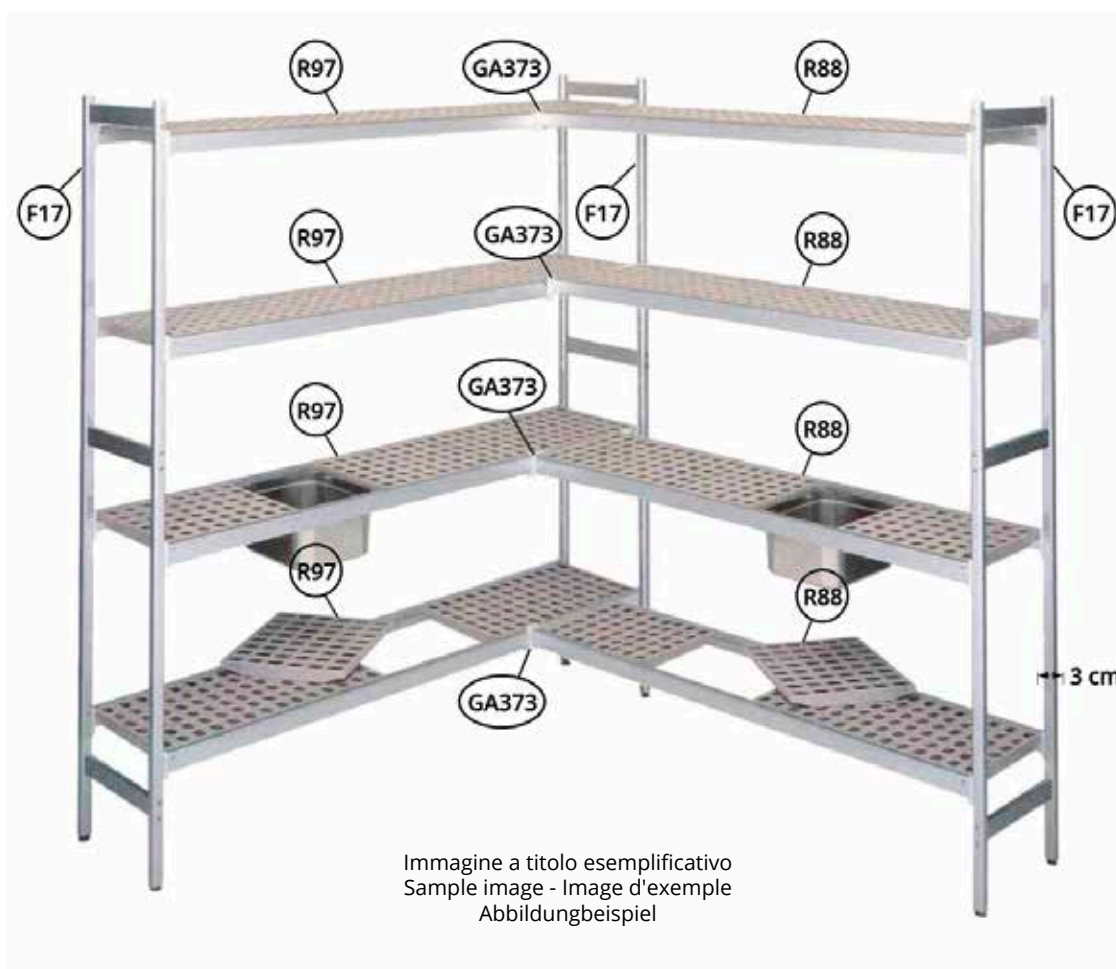

IT Scaffalatura modulare in alluminio anodizzato. Design rispondente alle norme igieniche con superfici lisce ed arrotondate, profili chiusi e totale assenza di spazi o fessure - leghe di alta qualità resistenti all'usura prodotta da agenti chimici, termici e meccanici - ampia scelta di misure - possibilità di inserimento vaschette serie Gastronorm GN1/2-GN1/1-GN2/1-GN2/3 inserite all'interno dei ripiani.

EN Modular shelving in anodized aluminium. Design in compliance with hygiene standards with smooth and rounded surfaces, closed profiles and total absence of spaces or gaps - high quality alloys resistant to wear produced by chemical, thermal and mechanical agents - wide choice of sizes - possibility of inserting Gastronorm containers GN1/2-GN1/1-GN2/1-GN2/3 inside the shelves.

FR Rayonnage modulaire en aluminium anodisé. Design hygiénique avec des surfaces lisses et arrondies, des profilés fermés et absence totale d'espaces ou de fissures - alliages de haute qualité résistants à l'usure par des agents chimiques, thermiques et mécaniques - large choix de dimensions - possibilité d'insérer des bacs Gastronorm GN1/2-GN1/1-GN2/1-GN2/1-GN2/3 dans les étages.

DE Modulare Regale aus eloxiertem Aluminium. Design nach Hygienestandards mit glatten und abgerundeten Oberflächen, geschlossenen Profilen und völliger Abwesenheit von Zwischenräumen oder Rissen - hochwertige, verschleißfeste Legierungen gegen chemischen, thermischen und mechanischen Werkstoffen - umfangreiche Größenauswahl - Behältern der Serie Gastronorm GN1/2-GN1/1-GN2/1-GN2/1-GN2/3, in den Regalen einsetzbar.

RIPIANI IN ALLUMINIO - ALUMINIUM SHELVES - ÉTAGÈRES EN ALUMINIUM - ALUMINIUMZWISCHENETAGEN

2 fiancate, 4 attacchi, serie griglie - 2 sides, 4 brackets, grids - 2 côtés, 4 supports, série de grilles - 2 Seitenpaneele, 4 Halterungen, Gittern

		Max. portata per piano lineare Linear shelf load capacity	Portata con giunzione ad angolo Load capacity with corner connection	Portata angolare Corner shelf load capacity	
R62	37,3 x 62 cm	250 kg	170 kg	100 kg	60 €
R88	37,3 x 88,6 cm	220 kg	140 kg	130 kg	70 €
R97	37,3 x 97,4 cm	210 kg	130 kg	120 kg	75 €
R106	37,3 x 106,2 cm	190 kg	120 kg	120 kg	80 €
R115	37,3 x 115,2 cm	170 kg	110 kg	110 kg	90 €
R124	37,3 x 124 cm	150 kg	100 kg	100 kg	90 €
R133	37,3 x 133 cm	140 kg	100 kg	80 kg	100 €
R150	37,3 x 150,5 cm	120 kg	90 kg	80 kg	105 €

Attenzione la portata max è intesa con carico uniformemente distribuito sul ripiano stesso  
Please note that the maximum load capacity is intended with an evenly distributed load on the shelf  
À noter que la capacité de charge maximale concerne une charge uniformément répartie sur l'étagère  
Hinweis: Die maximale Tragfähigkeit gilt für eine gleichmäßig verteilte Last auf dem Einlegeboden

FIANCATA IN ALLUMINIO - ALUMINIUM FRAME SIDE - FACE LATÉRALE EN ALUMINIUM - EDELSTAHL SEITENTEIL

2 piantane, 3 traversini, 2 piedi e 2 tappi - 2 pillars, 3 crosspieces, 2 feet and 2 plugs  
2 montants, 3 traverses, 2 pieds et 2 capuchons - 2 Träger, 3 Querstäbe, 2 Füße und 2 Kappen

	F15	F17	F20
	37,3 x 155(h) cm	37,3 x 170(h) cm	37,3 x 200(h) cm
	105 €	105 €	110 €

Attenzione lo spessore della fiancata è di 3 cm - Please note that the side thickness is 3 cm  
À noter que l'épaisseur de la face latérale est de 3 cm - Hinweis: Die Seitenteilstärke beträgt 3 cm

GIUNZIONI PER ANGOLO - CORNER JOINTS  
JOINTS DE COIN - ECKVERBINDUNGEN

	GA373
	37,3 cm
	25 €



# Attrezzatura per la colazione

BREAKFAST EQUIPMENT  
ÉQUIPEMENT DE PETIT-DÉJEUNER  
FRÜHSTÜCKSAUSRÜSTUNG

# TCE20101B



TCE20101B

# TCE20102B



TCE20102B

New

IT Chafing dish tondo con coperchio in vetro. Regolazione della temperatura da 40 a 95°C.

EN Round chafing dish with glass lid. Temperature regulation from 40 to 95°C.

FR Chafing dish rond avec couvercle en verre. Réglage de la température de 40 à 95°C.

DE Runder Chafing Dish mit Glasdeckel. Temperaturregelung von 40 bis 95°C.

IT Chafing dish quadrato con coperchio in vetro. Regolazione della temperatura da 40 a 95°C.

EN Square chafing dish with glass lid. Temperature regulation from 40 to 95°C.

FR Chafing dish carré avec couvercle en verre. Réglage de la température de 40 à 95°C.

DE Quadratischer Chafing Dish mit Glasdeckel. Temperaturregelung von 40 bis 95°C.

DISPONIBILE DA  
AVAILABLE FROM 01/2026

	TCE20101B
	500 W
 1 Ph	230V/1N/50-60 Hz
 cm	46 x 42 x 23(h) cm - 6 L - ø 38 cm
	550 €

	TCE20102B
	500 W
 1 Ph	230V/1N/50-60 Hz
 cm	42 x 40 x 23(h) cm - 5 L - GN2/3
	590 €

Chafing dishes

New

# TCE20104B



New

TCE20104B

- IT Chafing dish GN1/1 con coperchio in vetro. Regolazione della temperatura da 40 a 95°C.
- EN GN1/1 chafing dish with glass lid. Temperature regulation from 40 to 95°C.
- FR Chafing dish GN1/1 avec couvercle en verre. Réglage de la température de 40 à 95°C.
- DE GN1/1 Chafing Dish mit Glasdeckel. Temperaturregelung von 40 bis 95°C.

DISPONIBILE DA  
AVAILABLE FROM 01/2026

	TCE20104B
	500 W
 1 Ph	230V/1N/50-60 Hz
 cm	58 x 42 x 23(h) cm - 5 L - GN1/1
	670 €



# CD7905



CD7905

# CD9801



CD9801

IT Chafing dish con coperchio. Struttura rettangolare in acciaio inox - bruciatori ad alcool.

EN Chafing dish with lid. Rectangular stainless steel casing - alcohol burners.

FR Chafing Dish avec couvercle. Corps rectangulaire en acier inox - Brûleurs à alcool.

DE Chafing Dish mit Deckel. Rechteckige Edelstahlstruktur - Alkohol-Brenner.

IT Chafing dish con coperchio roll top. Struttura in acciaio inox lucido - bruciatori ad alcool.

EN Chafing dish with roll top lid. Rectangular polished stainless steel casing - alcohol burners.

FR Chafing Dish avec couvercle supérieur roll top. Corps rectangulaire en acier inox poli - Brûleurs à alcool.

DE Chafing Dish mit Roll-Top Deckel. Rechteckige polierte Edelstahlstruktur - Alkohol-Brenner.

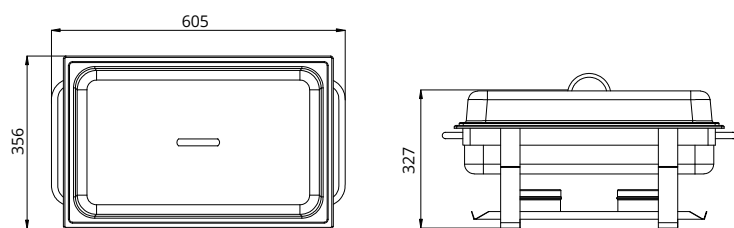

	CD7905
	60,5 x 35,6 x 32,7(h) cm - 8,5 L
	115 €

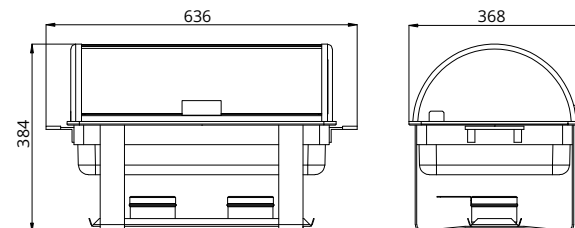

	CD9801
	63,6 x 36,8 x 38,4(h) cm - 8,5 L
	260 €

# CD6502



CD6502

# CD6504



CD6504

IT Chafing dish con coperchio roll top 180°. Struttura in acciaio inox lucido - bruciatori ad alcool.

EN Chafing dish with roll top lid 180°. Rectangular polished stainless steel casing - alcohol burners.

FR Chafing Dish avec couvercle supérieur roll top 180°. Corps rectangulaire en acier inox poli - Brûleurs à alcool.

DE Chafing Dish mit 180° Roll-Top Deckel. Rechteckige polierte Edelstahlstruktur - Alkohol-Brenner.

IT Chafing dish tondo con coperchio roll top 180°. Struttura in acciaio inox lucido - bruciatori ad alcool.

EN Round Chafing dish with roll top lid 180°. Rectangular polished stainless steel casing - alcohol burners.

FR Chafing Dish ronde avec couvercle supérieur roll top 180°. Corps rectangulaire en acier inox poli - Brûleurs à alcool.

DE Rundes Chafing Dish mit 180° Roll-Top Deckel. Rechteckige polierte Edelstahlstruktur - Alkohol-Brenner.

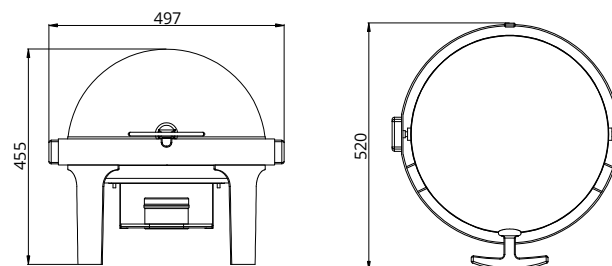
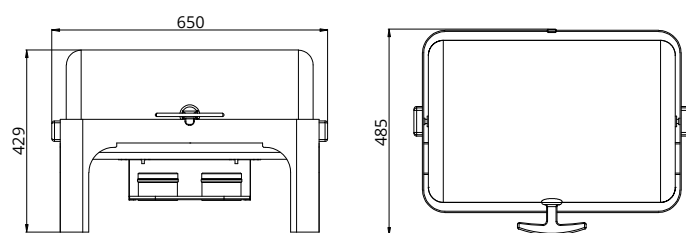

	CD6502
	65 x 48,5 x 42,9(h) cm - 8,5 L
	480 €

	CD6504
	49,7 x 52 x 45,5(h) cm - 6 L
	445 €

# CD6505



CD6505

- IT** Chafing dish con coperchio roll top 180° e pentole da 4,6 L Struttura in acciaio inox lucido - bruciatori ad alcool.
- EN** Chafing dish with roll top lid 180° and 4,6 L pans. Rectangular polished stainless steel casing - alcohol burners.
- FR** Chafing Dish avec couvercle supérieur roll top 180° t marmites de 4,6 L. Corps rectangulaire en acier inox poli - Brûleurs à alcool.
- DE** Chafing Dish mit 180° Roll-Top Deckel und 4,6 L. Töpfe. Rechteckige polierte Edelstahlstruktur - Alkohol-Brenner.

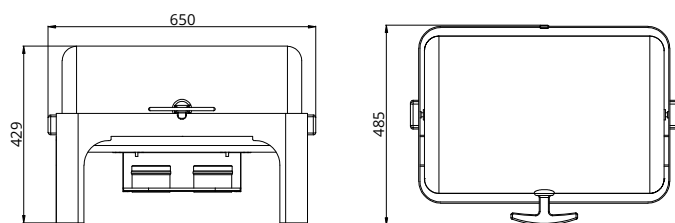

	CD6505
	65 x 48,5 x 42,9(h) cm
	580 €

# OPTIONAL



AV9516

- IT** Elemento di riscaldamento elettrico per Chafing Dishes.
- EN** Electric heating element fot Chafing Dishes.
- FR** Élément électrique de chauffage pour Chafing Dishes.
- DE** Elektrischer Heizelement für Chafing Dishes.

	AV9516
	CD7905 - CD9801 - CD6502 - CD6504 - CD6505
	360 W
	230V/1N/50-60 Hz
	24 x 18 cm (fori / holes 22 x 16 cm)
	110 €

# B8001



B8001

- IT Zuppiera elettrica. Corpo in alluminio verniciato - contenitore e coperchio in acciaio inox.
- EN Electric soup tureen. Painted aluminium casing - stainless steel container and lid.
- FR Soupière électrique. Corps en aluminium peint - récipient et couvercle en acier inox.
- DE Elektrische Terrine. Gehäuse aus lackiertem Aluminium - Behälter und Deckel aus Edelstahl.

	B8001
	360 W
	230V/1N/50 Hz
	ø 35 x 36(h) cm
	10 L
	245 €

Zuppiera elettrica  
Electric soup tureen

# DCN1706



DCN1706

- IT Distributore caldo per caffè. Struttura in ABS con copertura in acciaio inox - dotato di termica di sicurezza - temperatura 90°C.
- EN Hot coffee dispenser. ABS structure with stainless steel cover - equipped with safety thermic - temperature 90°C.
- FR Distributeur de café chaud. Corps en ABS avec couvercle en acier inox - équipée d'un thermique de sécurité - température 90°C.
- DE Heißkaffeenspender. ABS-Gehäuse mit Edelstahlabdeckung - ausgestattet mit Sicherheitsthermik - Temperatur 90°C

	DCN1706
	110 W
	230V/1N/50 Hz
	ø 29 x 44(h) cm
	7 L (40 tazzine - cup)
	275 €

Distributori caffè, bevande e cereali  
Coffee, drinks and cereals dispensers

# DC10502



DC10502

# DS10401 - DS10402



DS10401



DS10402

IT Distributore caldo per caffè. Struttura in acciaio inox - bruciatore ad alcool.

IT Distributore bevande. Contenitore trasparente - tubo centrale per contenimento ghiaccio.

EN Hot coffee dispenser. Stainless steel casing - alcohol burner.

EN Beverage dispenser. Clear container - central tube for ice filling.

FR Distributeur de café chaud. Corps en acier inox poli - Brûleurs à alcool.

FR Distributeur de boissons. Récipient transparent - tube central pour contenir de la glace.

DE Heißkaffeespender. Gehäuse aus Edelstahl - Alkohol-Brenner.

DE Getränkespender. Klarer Behälter - Zentralrohr für die Eiseinführung.



AV9517

	DC10502	AV9517
	33 x 24 x 54(h) cm	Elemento elettrico riscaldante Electric heating element Elément électrique chauffant Elektrischer Heizelement 180 W
	9 L	
	305 €	100 €

	DS10401	DS10402
	27 x 22 x 58(h) cm	32 x 32 x 58(h) cm
	8 L	5 + 5 L
	245 €	490 €

## DC10301 - DC10302



IT Distributore per cereali. Contenitori trasparenti, singoli o doppi.

EN Cereals dispenser. Clear containers, single or double.

FR Distributeur de céréales. Récipients transparents, simples ou doubles.

DE Müslispender. Transparente Behälter, einfach oder doppelt.

	DC10301	DC10302
	36 x 26 x 66(h) cm	48 x 26 x 66(h) cm
	8 L	8 + 8 L
	190 €	430 €

## T906







IT Bollitore elettrico in acciaio inox - spegnimento automatico al raggiungimento dell'ebollizione - due livelli di potenza - livello acqua visibile - base in plastica.

EN Stainless steel electric kettle - automatically switches off when boiling temperature is reached - two power levels - visible water level - plastic base.

FR Bouilloire électrique en acier inox. Arrêt automatique une fois la température d'ébullition atteinte - deux niveaux de puissance - niveau d'eau visible - base en plastique.

DE Elektrischer Wasserkocher aus Edelstahl - automatische Abschaltung beim Kochen - zwei Leistungsstufen - sichtbarer Wasserstand - Kunststoffsockel.

	T906
	1850 - 2200 W
	230V/1N/50-60Hz
	1,7 L
	15 x 22 x 23(h) cm
	50 €

Bollitore elettrico  
Electric kettle

**EASYLINE**  
by Eline  
SNACKWARE EQUIPMENT

## AV4561



AV4561

IT Fornello flambé a gas in rame con griglia in acciaio inox.

EN Copper gas flambé cooker with stainless steel grid.

FR Cuisinière flambée à gaz en cuivre avec grille en acier inox.

DE Flambé Gasherd aus Kupfer mit Edelstahlgitter.

## AV4580 - AV4581



AV4580

IT Padella flambè inox-cuprum, manico legno.

EN Flambé pan stainless steel-cuprum, wooden handle.

FR Poêle flambée en acier inox-cuprum, manche en bois.

DE Flambé Cuprum-Pfanne aus Edelstahl mit Holzgriff.

	AV4561
	ø 26 x 29,5(h) cm
	470 €

	AV4580	AV4581
	ø 29 cm	ø 26 cm
	185 €	140 €

Fornello - Padella Flambè  
Flambé cooker - pan



# Articoli vari

per cucina e pizzeria

ITEMS FOR COOKING AND PIZZERIA  
ARTICLES POUR LA CUISINE  
ET POUR LA PIZZERIA  
KÜCHE- UND PIZZERIA-ARTIKEL



ACCIAIO INOX AISI 304 - STAINLESS STEEL AISI 304



BACINELLE - CONTAINERS BASSINES - BEHÄLTER					
<b>MOD. 2/1</b> Est. 646 x 530 mm Int. 620 x 500 mm		GNI21200	20(h) cm	60 L	142 €
		GNI21150	15(h) cm	44,9 L	116 €
		GNI21100	10(h) cm	31,5 L	86 €
		GNI2165	6,5(h) cm	18,9 L	63 €
		GNI2140	4(h) cm	12 L	60 €
		GNI2120	2(h) cm	6,5 L	57 €
		GRI21	Griglia / Grill		59 €
<b>MOD. 1/1</b> Est. 530 x 325 mm Int. 500 x 300 mm		GNI11200	20(h) cm	30 L	75 €
		GNI11150	15(h) cm	20,6 L	64 €
		GNI11100	10(h) cm	13,3 L	45 €
		GNI1165	6,5(h) cm	8,5 L	34 €
		GNI1140	4(h) cm	5,5 L	29 €
		GNI1120	2(h) cm	2,5 L	25 €
		COPI 11	Coperchio / Lid		27 €
		COPG11	Coperchio a tenuta Leak-proof lid		72 €
		FFF11	Falso fondo forato Perforated false bottom		27 €
		GRI11	Griglia / Grill		37 €
		S530	Separatore / Divider		8 €
<b>MOD. 2/3</b> Est. 352 x 325 mm Int. 329 x 300 mm		GNI23200	20(h) cm	19,3 L	62 €
		GNI23150	15(h) cm	13,6 L	52 €
		GNI23100	10(h) cm	8,9 L	34 €
		GNI2365	6,5(h) cm	5,5 L	24 €
		GNI2340	4(h) cm	3,5 L	23 €
		GNI2320	2(h) cm	1,8 L	18 €
		COPI23	Coperchio / Lid		18 €
		COPG23	Coperchio a tenuta Leak-proof lid		54 €
		FFF23	Falso fondo forato Perforated false bottom		22 €
		GRI23	Griglia / Grill		25 €

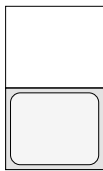
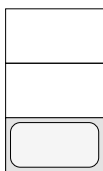
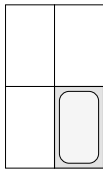

ACCIAIO INOX AISI 304 - STAINLESS STEEL AISI 304

BACINELLE - CONTAINERS BASSINES - BEHÄLTER				
<b>MOD. 1/2</b> Est. 325 x 265 mm Int. 300 x 238 mm 	GNI12200	20(h) cm	11,6 L	41 €
	GNI12150	15(h) cm	9,9 L	38 €
	GNI12100	10(h) cm	8 L	27 €
	GNI1265	6,5(h) cm	4,2 L	20 €
	GNI1240	4(h) cm	2,5 L	18 €
	GNI1220	2(h) cm	1,2 L	15 €
	COPI12	Coperchio / Lid		15 €
	COPG12	Coperchio a tenuta Leak-proof lid		47 €
	FFF12	Falso fondo forato Perforated false bottom		15 €
	S325	Separatore / Divider		6 €
<b>MOD. 1/3</b> Est. 325 x 176 mm Int. 300 x 150 mm 	GNI13200	20(h) cm	8,1 L	40 €
	GNI13150	15(h) cm	5,9 L	30 €
	GNI13100	10(h) cm	3,8 L	18 €
	GNI1365	6,5(h) cm	2,5 L	16 €
	GNI1340	4(h) cm	1,5 L	14 €
	GNI1320	2(h) cm	0,7 L	10 €
	COPI13	Coperchio / Lid		11 €
	COPG13	Coperchio a tenuta Leak-proof lid		42 €
	FFF13	Falso fondo forato Perforated false bottom		12 €
	<b>MOD. 1/4</b> Est. 265 x 162 mm INT. 238 x 136 mm 	GNI14200	20(h) cm	4,9 L
GNI14150		15(h) cm	4,1 L	22 €
GNI14100		10(h) cm	2,5 L	18 €
GNI1465		6,5(h) cm	1,9 L	15 €
GNI1440		4(h) cm	1 L	14 €
GNI1420		2(h) cm	0,5 L	11 €
COPI14		Coperchio / Lid		9 €
COPG14		Coperchio a tenuta Leak-proof lid		37 €
S265		Separatore / Divider		6 €





ACCIAIO INOX AISI 304 - STAINLESS STEEL AISI 304					
BACINELLE - CONTAINERS BASSINES - BEHÄLTER					
<b>MOD. 1/6</b> Est. 176 x 162 mm Int. 140 x 153 mm		GNI16200	20(h) cm	3 L	35 €
		GNI16150	15(h) cm	2,5 L	21 €
		GNI16100	10(h) cm	1,6 L	17 €
		GNI1665	6,5(h) cm	1,1 L	14 €
		COP116	Coperchio / Lid		8 €
		COPG16	Coperchio a tenuta Leak-proof lid		27 €
<b>MOD. 1/9</b> Est. 176 x 108 mm Int. 140 x 100 mm		GNI19100	10(h) cm	0,9 L	16 €
		GNI1965	6,5(h) cm	0,5 L	13 €
		COP119	Coperchio / Lid		7 €



**ATTENZIONE** i coperchi a tenuta possono essere applicati solo su bacinelle GN con H mm. 100, 150 e 200

**ATTENTION** the leak-proof lids can only be applied to GN basins with H 100, 150 and 200 mm.

**ATTENTION** les couvercles anti-fuite ne peuvent être appliqués que sur des bassines GN avec H 100, 150 et 200 mm.

**ACHTUNG** Die versiegelten Deckel können nur bei GN-Behältern mit H 100,150 und 200mm eingesetzt werden.

ACCIAIO INOX AISI 304 - STAINLESS STEEL AISI 304					
BACINELLE FORATE PIERCED BASINS - CUVETTES PERCÉES - LOCHSCHALE					
<b>MOD. 2/1</b> Est. 646 x 530 mm Int. 620 x 500 mm		GNT21200	20(h) cm	60 L	184 €
		GNT21150	15(h) cm	44,9 L	160 €
		GNT21100	10(h) cm	31,5 L	120 €
		GNT2165	6,5(h) cm	18,9 L	100 €
<b>MOD. 1/1</b> Est. 530 x 325 mm Int. 500 x 300 mm		GNT11200	20(h) cm	30 L	91 €
		GNT11150	15(h) cm	20,6 L	74 €
		GNT11100	10(h) cm	13,3 L	48 €
		GNT1165	6,5(h) cm	8,5 L	43 €
<b>MOD. 2/3</b> Est. 352 x 325 mm Int. 329 x 300 mm		GNT23200	20(h) cm	19,3 L	62 €
		GNT23150	15(h) cm	13,6 L	52 €
		GNT23100	10(h) cm	8,9 L	37 €
		GNT2365	6,5(h) cm	5,5 L	35 €
<b>MOD. 1/2</b> Est. 325 x 265 mm Int. 300 x 238 mm		GNT12200	20(h) cm	11,6 L	58 €
		GNT12150	15(h) cm	9,9 L	45 €
		GNT12100	10(h) cm	8 L	34 €
		GNT1265	6,5(h) cm	4,2 L	23 €







GNT21100





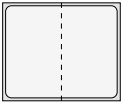

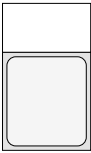
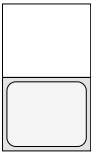
GNT21200



ACCIAIO INOX AISI 304 - STAINLESS STEEL AISI 304

TEGLIE FONDO FORATO TRAYS PERFORATED BOTTOM					
<b>MOD. 2/1</b> Est. 646 x 530 mm Int. 620 x 500 mm		GNF2120	2(h) cm	6,5 L	62 €
		GNF2140	4(h) cm	12 L	70 €
		GNF2165	6,5(h) cm	18,9 L	75 €
<b>MOD. 1/1</b> Est. 530 x 325 mm Int. 500 x 300 mm		GNF1120	2(h) cm	2,5 L	28 €
		GNF1140	4(h) cm	5,5 L	33 €
		GNF1165	6,5(h) cm	8,5 L	36 €
<b>MOD. 2/3</b> Est. 352 x 325 mm Int. 329 x 300 mm		GNF2320	2(h) cm	1,8 L	20 €
		GNF2340	4(h) cm	3,5 L	25 €
		GNF2365	6,5(h) cm	5,5 L	28 €
<b>MOD. 1/2</b> Est. 325 x 265 mm Int. 300 x 238 mm		GNF1220	2(h) cm	1,2 L	17 €
		GNF1240	4(h) cm	2,5 L	19 €
		GNF1265	6,5(h) cm	4,2 L	22 €

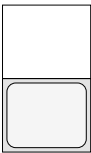
POLICARBONATO - POLYCARBONATE

BACINELLE GN GN CONTAINERS					
<b>MOD. 1/1</b> Est. 530 x 325 mm Int. 500 x 300 mm		GNP11200	20(h) cm	30 L	31 €
		GNP11150	15(h) cm	20,6 L	30 €
		GNP11100	10(h) cm	13,3 L	20 €
		GNP1165	6,5(h) cm	8,5 L	21 €
		COPP11	Coperchio / Lid		12 €
		GFP11	Griglia forata / Perforated grid 46 x 25,5 cm		9 €
		<b>MOD. 1/2</b> Est. 325 x 265 mm Int. 300 x 238 mm		GNP12200	20(h) cm
GNP12150	15(h) cm			9,9 L	15 €
GNP12100	10(h) cm			8 L	12 €
GNP1265	6,5(h) cm			4,2 L	11 €
COPP12	Coperchio / Lid			9 €	
GFP12	Griglia forata / Perforated grid 25 x 19 cm			6 €	

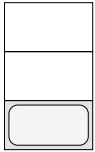
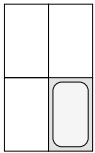
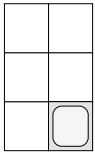
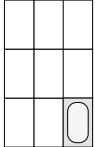

POLICARBONATO - POLYCARBONATE				
BACINELLE GN GN CONTAINERS				
<b>MOD. 1/3</b> Est. 325 x 176 mm Int. 300 x 150 mm 	GNP13200	20(h) cm	8,1 L	16 €
	GNP13150	15(h) cm	5,9 L	13 €
	GNP13100	10(h) cm	3,8 L	9 €
	GNP1365	6,5(h) cm	2,5 L	8 €
	COPP13	Coperchio / Lid		5 €
	GFP13	Griglia forata / Perforated grid 25 x 11 cm		4 €
<b>MOD. 1/4</b> Est. 265 x 162 mm INT. 238 x 136 mm 	GNP14200	20(h) cm	4,9 L	12 €
	GNP14150	15(h) cm	4,1 L	10 €
	GNP14100	10(h) cm	2,5 L	8 €
	GNP1465	6,5(h) cm	1,9 L	7 €
	COPP14	Coperchio / Lid		4 €
	GFP14	Griglia forata / Perforated grid 21 x 11 cm		4 €
<b>MOD. 1/6</b> Est. 176 x 162 mm Int. 140 x 153 mm 	GNP16200	20(h) cm	3 L	10 €
	GNP16150	15(h) cm	2,5 L	8 €
	GNP16100	10(h) cm	1,6 L	7 €
	GNP1665	6,5(h) cm	1,1 L	5 €
	COPP16	Coperchio / Lid		3 €
	GFP16	Griglia forata / Perforated grid 11,5 x 10 cm		3 €
<b>MOD. 1/9</b> Est. 176 x 108 mm Int. 140 x 100 mm 	GNP19100	10(h) cm	0,9 L	4 €
	GNP1965	6,5(h) cm	0,5 L	4 €
	COPP19	Coperchio / Lid		3 €





GNP1165



GNP13200



COPERCHI IN PLASTICA - PLASTIC LIDS			
			
 CP3	CP2	26,5 x 16,5 cm	11 €
	CP3	33 x 16,5 cm	13 €
	CP4	36 x 16,5 cm	15 €

Bacinelle Gastronorm e coperchi  
Containers Gastronorm and plastic lids

TEGLIA BLUREX - BLUREX TRAY - PLAQUE BLUREX - BLUREX-BLECH			
	AV4937	60 x 40 x 2(h) cm	20 €
	AV4947	60 x 30 x 2(h) cm	20 €
TEGLIA SMALTATA - COATED TRAY - PLAQUE ÉMAILLÉE - BESCHICHTETES BLECH			
	GNS1120	GN1/1 2(h) cm	34 €
	GNS1140	GN1/1 4(h) cm	36 €
	GNS1165	GN1/1 6,5(h) cm	37 €
TEGLIA ALLUMINATA - ALUMINIUM COATED TRAY PLAQUE EN ALUMINIUM - ALUMINIUM BESCHICHTETES BLECH			
	AV4940	60 x 40 x 2(h) cm	23 €
	AV4950	60 x 30 x 2(h) cm	20 €
TEGLIA FORATA ALLUMINIO - ALUMINIUM PERFORATED TRAY PLAQUE PERFORÉE EN ALUMINIUM - GELOCHTES BLECH AUS ALUMINIUM			
	AVF4940	60 x 40 x 2(h) cm	40 €
TEGLIA ALLUMINIO - ALUMINIUM TRAY PLAQUE EN ALUMINIUM - BLECH AUS ALUMINIUM			
	AVC4940	GN1/1 - 2(h) cm	30 €
	AV4980	60 x 40 x 2(h) cm	30 €

BACINELLA PORTABOTTIGLIE IN ACCIAIO INOX - STAINLESS STEEL BOTTLE TRAY			
	A500	50,3 x 32 x 8(h) cm	130 €
		Mod. CA1455/65/75 - CA1455V12 - CA1479 CA1450/60/70 - CA1451R/61R/71R - CA1489R	



VASSOIO IN POLIPROPILENE MARRONE  
POLYPROPYLENE TRAY BROWN

			
AV4582	53 x 32,5(h) cm	Gastronorm	18 €
AV4583	53 x 37(h) cm	Euronorm	18 €



VG361615

VG331612

AV4583

VASCHETTE GELATO ACCIAIO INOX  
ICE CREAM CONTAINERS STAINLESS STEEL

			
VG261612	26 x 16,5 x 12(h) cm	3,5 L	29 €
VG261615	26 x 16,5 x 15(h) cm	4 L	36 €
VG33168	33 x 16,5 x 8(h) cm	3,5 L	27 €
VG331612	33 x 16,5 x 12(h) cm	5 L	34 €
VG331615	33 x 16,5 x 15(h) cm	6,5 L	35 €
VG36168	36 x 16,5 x 8(h) cm	4 L	26 €
VG361612	36 x 16,5 x 12(h) cm	5,4 L	32 €
VG361615	36 x 16,5 x 15(h) cm	7 L	36 €
VG361618	36 x 16,5 x 18(h) cm	9 L	41 €
VG36258	36 x 25 x 8(h) cm	5 L	32 €
VG362512	36 x 25 x 12(h) cm	8 L	32 €



Vaschette gelato  
Ice cream containers

# BL4545



BL4545

**IT** Bilancia elettronica, fino a 15 kg con divisione in grammi 5. Corpo in ABS - piatto inox 28x21 cm - acquisizione tara - bolla di livello incorporata - tastiera con protezione antispruzzo - alimentazione a batteria ricaricabile - peso bilancia (batterie escluse) 4,1 kg. Non adatta per la vendita al pubblico.

**EN** Electronic Scale, up to 15 kg with division in 5 grams. - ABS casing - 28x21 cm stainless steel plate - tare acquisition - built-in level bubble - keyboard with splash protection - rechargeable battery power supply - scale weight (without batteries) 4,1 kg. Not suitable for retail sale.

**FR** Balance électronique, jusqu'à 15 kg avec division en 5 grammes. Corps en ABS - plaque en acier inox 28x21 cm - acquisition de la tare - bulle de niveau intégrée - clavier avec protection anti-rayures - alimentation par batterie rechargeable - poids balance (sans piles) 4,1 kg. Ne peut pas être vendue au public.

**DE** Elektronische Waage bis 15 kg mit Einteilung in Gramm 5. ABS Gehäuse - Edelstahltabelle 28x21 cm - Tara-Erfassung - eingebaute Libelle - Tastatur mit Spritzschutz - Akku-Stromversorgung - Waagengewicht (ohne Batterien) 4,1 kg. Nicht für den Einzelhandel geeignet.

# BP4548



BP4548

**IT** Bilancia elettronica, fino a 60 kg con divisione in grammi 20. Corpo in ABS - piatto inox 32x33 cm - acquisizione tara - alimentazione a batteria + alimentatore - peso bilancia (batterie escluse) 4,5 kg. Non adatta per la vendita al pubblico.

**EN** Electronic Scale, up to 60 kg with division in 20 grams. ABS casing - 32x33 cm stainless steel plate - tare acquisition - battery power supply + transformer - scale weight (without batteries) 4,5 kg. Not suitable for retail sale.

**FR** Balance électronique, jusqu'à 60 kg avec division en 20 grammes. Corps en ABS - plaque en acier inox 32x33 cm - acquisition de la tare - alimentation par batterie + alimentation - poids de la balance (sans piles) 4,5 kg. Ne peut pas être vendue au public.

**DE** Elektronische Waage bis 60 kg mit Einteilung in Gramm 20. ABS Gehäuse - Edelstahltabelle 32x33 cm - Tara-Erfassung - Akku-Stromversorgung + Netzteil - Waagengewicht (ohne Batterien) 4,5 kg. Nicht für den Einzelhandel geeignet.

	BL4545
	230V - 7 W
	29 x 33 x 22(h) cm
	368 €

	BP4548
	230V - 2 W
	31 x 30 x 5(h) cm
	296 €

## AV4510



AV4510

- IT Morsa per prosciutto. Corpo in acciaio inox - supporto e manici in legno pregiato.
- EN Ham stand. Stainless steel structure - support and handles in fine wood.
- FR Serre-jambon. Corps en acier inox - support et poignées en bois de haute qualité.
- DE Schinkengriff. Edelstahlkörper - Stütze und Griffe aus edlem Holz.

	AV4510
	58 x 25 x 19(h) cm
	190 €

## AV4515



AV4515

- IT Morsa per prosciutto. Corpo in acciaio - supporto e manici in legno.
- EN Ham stand. Stainless steel structure - support and handles in fine wood.
- FR Serre-jambon. Corps en acier - support et poignées en bois.
- DE Schinkengriff. Edelstahlkörper - Stütze und Griffe aus edlem Holz.

	AV4515
	58 x 25 x 19(h) cm
	60 €

## AV4500

- IT Apriscatole da banco. Struttura in acciaio cementato - coltello in acciaio inox - alzacoperchi magnetico max 20(h) cm.
- EN Counter can opener. Case hardened steel structure - stainless steel knife - magnetic lid lifter max 20(h) cm.
- FR Ouvre-boîte pour comptoir. Structure en acier cémenté - couteau en acier inox - souleveuse de couvercle magnétique max 20(h) cm.
- DE Tisch-Dosenöffner. Einsatzgehärtete Stahlstruktur - Edelstahlmesser - Magnetdeckelheber Max 20(h) cm.



	AV4500	R4501	R4502
	10 x 23 x 69(h) cm	Lama di ricambio Spare blade	Ingranaggio ricambio Spare gear
	120 €	19 €	19 €



## AV4960-AV4961



- IT Pala in alluminio forata per uso professionale.  
 EN Perforated aluminium peel for professional use.  
 FR Pelle en aluminium perforée pour usage professionnel.  
 DE Perforierte Aluminiumschaufel für den professionellen Einsatz.

i	AV4960	AV4961
↗ cm	33 x 33 x 170(h) cm	36 x 36 x 170(h) cm
	200 €	210 €

## AV4926-AV4927-AV4930



- IT Pala in alluminio per uso professionale.  
 EN Aluminium peel for professional use.  
 FR Pelle en aluminium pour usage professionnel.  
 DE Aluminiumschaufel für den professionellen Einsatz.

i	AV4926	AV4927	AV4930/50
↗ cm	33 x 33 x 170(h) cm	36 x 36 x 170(h) cm	50 x 50 x 170(h) cm
	175 €	185 €	225 €

## AV4925-AV4928-AV4929



- IT Pala in alluminio.  
 EN Aluminium peel.  
 FR Pelle pizza en aluminium.  
 DE Aluminiumschaufel.

i	AV4925	AV4928	AV4929
↗ cm	33 x 33 x 135(h) cm	33 x 33 x 170(h) cm	36 x 36 x 170(h) cm
	120 €	130 €	140 €

## AV4922-AV4923



- IT Palino in acciaio forato.  
 EN Perforated steel turning peel.  
 FR Pelle de cuisson en acier perforé.  
 DE Perforierter Brotschieber.

i	AV4922	AV4923
↗ cm	ø 18 x 170(h) cm	ø 22 x 170(h) cm
	130 €	135 €

## AV4920-AV4921



IT Palino in acciaio.

FR Pelle de cuisson en acier.

EN Steel turning peel.

DE Brotschieber.

	AV4920	AV4921
	ø 18 x 170(h) cm	ø 22 x 170(h) cm
	116 €	125 €



## AV4965

IT Pala in alluminio forni elettrici e a gas.

EN Aluminium peel for electric and gas ovens.

FR Pelle en aluminium fours électriques et à gaz.

DE Aluminiumschaufel Elektro- und Gasöfen.



	AV4965
	33 x 35 x 70(h) cm
	75 €

## AV4966

IT Pala per pizza al metro.

EN Peel for pizza by the meter.

FR Pelle à pizza au mètre.

DE Pizza am Stück Schaufel.



	AV4966
	60 x 40 x 170(h) cm
	250 €

## AV4905-AV4931

IT Paletta servi pizza in acciaio.

EN Steel pizza serving peel.

FR Pelle pour servir des pizzas en acier.

DE Pizza-Service Stahlschaufel.



	AV4905	AV4931
	ø 50 cm a 8 porzioni ø 50 cm with 8 portions	ø 33 cm
	95 €	70 €

## AV4948

IT Paletta per pizza triangolare in acciaio.

EN Steel triangular pizza paddle.

FR Pelle triangulaire en acier pour pizza.

DE Dreieckiger Stahlschaufel für Pizza.



	AV4948
	15 x 25 cm
	55 €

## AV4932

IT Spatola in acciaio inox.  
EN Stainless steel spatula.  
FR Spatule en acier inox.  
DE Edelstahlspachtel.



	AV4932
	20 €

## AV4954

IT Paletta per pizza in acciaio.  
EN Steel pizza paddle.  
FR Pelle à pizza en acier.  
DE Stahlschaufel für Pizza.



	AV4954
	10 x 15 cm
	32 €

## AV4941

IT Pinza prenditeglie.  
EN Tray clamps.  
FR Pincés prend plaques.  
DE Blechklemme.



	AV4941
	55 €

## AV4934

IT Rotella taglia pizza.  
EN Pizza cutting wheel.  
FR Molette coupe pizza.  
DE Grädchen zur Pizza schneiden.



	AV4934
	ø 9 cm
	30 €

## AV4933

IT Bucasfoglia in lega.  
EN Alloy puff pastry perforator.  
FR Perforateur de pâte feuilletée en alliage.  
DE Legierung Blätterteiglöcherer.





	AV4933
	80 €

## AV4949

IT Rotella taglia pizza professionale.  
EN Professional pizza cutter.  
FR Roue coupe-pizza professionnelle.  
DE Professionelles Pizzaschneidrad.



	AV4949
	ø 9 cm
	75 €

## AV4946



IT Raschietto inox.  
EN Stainless steel scraper.  
FR Racloir inox.  
DE Edelstahl Schaber.

	AV4946
	12 cm
	25 €

## AV4911



IT Paletta per cenere.  
EN Peel for ashes.  
FR Pelle à cendres.  
DE Ascheschaufel.

	AV4911
	170(h) cm
	115 €

## AV4912



IT Spazzola in fibra naturale.  
EN Natural fibre brush.  
FR Brosse en fibres naturelles.  
DE Naturfaserbürste.

	AV4912	A42
	170(h) cm	Spazzola di ricambio in fibra naturale / Natural fibre brush
	110 €	30 €

## AV4919





IT Spazzola in ottone per forni a legno.  
EN Brass brush for wood ovens.  
FR Brosse en laiton pour fours à bois.  
DE Messingbürste für Holzöfen.

	AV4919	A43
	170(h) cm	Spazzola di ricambio in ottone Spare brass brush
	115 €	32 €

## AV4959



- IT Spazzola ottone girevole a mezzaluna.  
 EN Brass swivel half-moon brush.  
 FR Brosse pivotante en laiton en forme de demi-lune.  
 DE Schwenkbare Halbmondbürste aus Messing.

	AV4959	A45
	170(h) cm	Ricambio spazzolone a mezzaluna Spare half moon brush
	130 €	42 €

## AV4971



- IT Spazzola doppia / ottone e raschietto in acciaio inox.  
 EN Double brush / brass and stainless steel scraper.  
 FR Brosse double / laiton et racloir inox.  
 DE Doppelbürste / Messing und Edelstahlschaber.

	AV4971	A44
	110(h) cm	Ricambio spazzola doppia Spare double moon brush
	80 €	41 €

## AV4970



- IT Kit 3 pezzi 170(h) cm (pala ø 33 cm - palino ø 18 cm - spazzola).  
 EN Kit 3 pieces 170(h) cm (ø 33 cm pizza peel - ø 18 cm turning peel - brush).  
 FR Kit 3 pièces 170(h) cm (pelle ø 33 cm - pelle ø 18 cm - brosse).  
 DE 3-teiliger Satz 170(h) cm (Schaufel ø 33 cm - kleine Schaufel ø 18 cm - Bürste).

	AV4970
	170(h) cm
	300 €

## AV4972



- IT Kit 3 pezzi 135(h) cm (pala ø 33 cm - palino ø 22 cm - spazzola).  
 EN Kit 3 pieces 135(h) cm (ø 33 cm pizza peel - ø 22 cm turning peel - brush).  
 FR Kit 3 pièces 135(h) cm (pelle ø 33 cm - pelle ø 22 cm - brosse).  
 DE 3-teiliger Satz 135(h) cm (Schaufel ø 33 cm - kleine Schaufel ø 22 cm - Bürste).

	AV4972
	135(h) cm
	230 €

## AV4916



	AV4916
	Cassetta per appoggio pale Peel support box Cassette pour support de pelles Schaufelstützkasten
	92 €

## AV4913



	AV4913
	Supporto reggipale a muro Wall peel support Support mural pour pelles Wandschaufelhalter
	60 €

## AV4914



	AV4914
	Supporto reggipale a muro Wall peel support Support mural pour pelles Wandschaufelhalter
	70 €

## AV4910

- IT Supporto reggipale.  
EN Peel support.  
FR Support de pelles.  
DE Schaufelträger.

	AV4910
	42 x 24 x 160(h) cm
	350 €



## AV4952 - AV4953

- IT Retina tonda inox.  
 EN Little round stainless steel net.  
 FR Grille ronde en acier inox.  
 DE Rundes Edelstahlnetz.

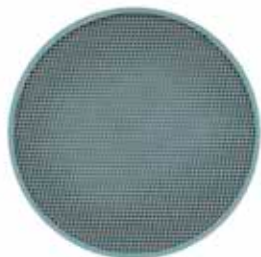

## AV4956 - AV4957

- IT Retina tonda alluminio.  
 EN Little round aluminium net.  
 FR Grille ronde en aluminium.  
 DE Rundes Aluminiumnetz.



	AV4952	AV4953
	ø 33 cm	ø 45 cm
	30 €	45 €

	AV4956	AV4957
	ø 33 cm	ø 45 cm
	20 €	30 €

## AV4909 - AV4967 - AV4938 - AV4939

- IT Contenitore per impasti pizza.  
 EN Pizza dough container.  
 FR Conteneur pour pâte à pizza.  
 DE Pizzateigbehälter.



AV4909



AV4967



AV4938



AV4939

	AV4909	AV4967	AV4938	AV4939 Coperchio/Cover
	60 x 40 x 13(h) cm	60 x 40 x 9(h) cm	60 x 40 x 7,5(h) cm	60 x 40 cm
	25 €	17 €	15 €	14 €

## AV4973



IT Portapizze rigido, interno in alluminio.

EN Sturdy pizza holder, internally made of aluminium.

FR Conteneur thermique, intérieur en aluminium.

DE Starres Pizzaregal aus Aluminium.

	AV4973
	47 x 47 x 52(h) cm
	n. 10 pizze / pizzas (ø 33 cm)
	440 €

## AV4975



IT Borsa termica per consegna a domicilio.

EN Heating Bag for home delivery.

FR Sac thermique pour la livraison à domicile.

DE Wärmetasche für den Heimlieferdienst.

	AV4975
	37 x 37 x 20(h) cm
	n. 5 pizze / pizzas (ø 33 cm)
	70 €

## AV4974



IT Piastra di fissaggio al portapacchi ciclomotore (per art. AV4973).

EN Fixing plate for moped luggage rack (for art. AV4973).

FR Plaque de fixation sur le porte-bagages du cyclomoteur (pour art. AV4973).

DE Befestigungsplatte am Mopedgepäckträger (für Art. AV4973).

	AV4974
	35 x 37 x 6,5(h) cm
	125 €

## AV4918



IT Alare per appoggio legna.

EN Andiron stand for firewood.

FR Chenet pour appui bois.

DE Tragfläche für Holz.

	AV4918
	16 x 40 x 12(h) cm
	105 €



# Pattumiere portarifiuti

GARBAGE AND DUST BINS  
POUBELLES  
MÜLL- UND ABFALLBEHÄLTER

## AV4650 AV4651



AV4650

- IT Posacenere, gettacarte, pattumiere e portarifiuti - coperchio a rete cromata.
- EN Ashtrays, paper baskets, garbage bins and dust bins - chromed mesh lid.
- FR Cendriers, corbeilles à papier, poubelles et conteneur de déchets - couvercle en filet chromé.
- DE Aschenbecher, Papierkorb, Mülleimer und Abfallbehälter - verchromter Netzdeckel.

	AV4650	AV4651
	ø 20 - 60(h) cm	ø 25 - 70(h) cm
	115 €	175 €

## AV4620



AV4620

- IT Gettacarte in acciaio inox satinato Autoestinguente, testa soffocante per l'arresto della propagazione del fuoco - base in gomma.
- EN Satin stainless steel paper basket, Self-extinguishing, stifling end to stop the propagation of fire - rubber base.
- FR Corbeille à papier en acier inox satiné, Eteignant automatiquement, tête suffocante pour arrêter la propagation du feu - base en caoutchouc.
- DE Papierkorb aus satiniertem Edelstahl, Selbstlöschend erstickender Deckel zur Verhinderung der Ausbreitung von Feuer - Gummifuß.

	AV4620
	ø 31 - 59(h) cm
	50 L
	160 €

## AV4671



AV4671

- IT Pattumiera con ruote, senza pedale.
- EN Garbage bin with wheels, without pedal.
- FR Poubelle à roulettes, sans pédale.
- DE Mülleimer mit Rädern, ohne Fußhebel.

	AV4671
	ø 40 x 76(h) cm
	70 L
	290 €

## AV4666 - AV4680



AV4666

- IT Tramoggia su ruote. Struttura in acciaio inox satinato. Coperchio asportabile.
- EN Hopper on wheels. Satin stainless steel casing. Removable lid.
- FR Trémie sur roues. Corps en acier inox satiné. Couvercle amovible.
- DE Trichter auf Rädern. Gehäuse aus Edelstahl matt geschliffen. Abnehmbarer Deckel.

## AV4667 AV4668

## AV4669



AV4668



AV4669

- IT Portarifiuti carrellato. Struttura a forma cilindrica in acciaio inox - completo di coperchio stampato - fondo a tenuta stagna - ruote multidirezionali. AV4667-68 con comando a pedale.
- EN Wheeled waste bin. Cylindrical stainless steel structure - Complete with shaped lid - watertight bottom - multidirectional wheels. AV4667-68 with pedal control.
- FR Chariot-poubelle. Corps cylindrique en acier inox - complète de couvercle imprimée - fond étanche - roues multidirectionnelles. AV4667-68 avec commande à pédale.
- DE Abfalleimer auf Rädern. Zylindrisches Edelstahlgehäuse - mit vorgeformtem Deckel - wasserdichter Boden - Mehrwegräder. AV4667-68 mit Fußhebel.

i	AV4666	AV4680 con separatore interno with internal separator
cm	61 x 40 x 73(h) cm	
L	115 L	
	465 €	550 €

i	AV4667	AV4668	AV4669
cm	ø 39 x 60(h) cm	ø 46 x 70(h) cm	
L	50 L	100 L	
	230 €	265 €	200 €

# AV4654

# AV4652

# AV4681



AV4654



AV4652



AV4681

IT Pattumiera rettangolare - Struttura in acciaio inox comando apertura a pedale - estrazione sacco anteriore - 2 ruote.

EN Rectangular waste bin - Stainless steel structure pedal opening control - front bag extraction - 2 wheels.

FR Poubelle rectangulaire - Corps en acier inox commande d'ouverture par pédale - extraction du sac à l'avant - 2 roues.

DE Rechteckiger Abfalleimer - Gehäuse aus Edelstahl Fußhebelöffnung - vordere Sackentnahme - 2 Räder.

IT Pattumiera portasacco. Attacco rotondo in acciaio inox coperchio con apertura a pedale. Sacco non incluso.

EN Bag holder. Round stainless steel fitting, lid with pedal opening. Bag not included.

FR Poubelle Porte-sac. Support rond en acier inox couvercle avec ouverture par pédale. Sac non inclus.

DE Müllsackhalterung. Runder Edelstahldeckel mit Fußhebelöffnung. Sack nicht inbegriffen.

	AV4654	AV4652
	49 x 50 x 79(h) cm	49 x 50 x 101(h) cm
	70 L	100 L
	495 €	550 €

	AV4681
	55 x 45 x 85(h) cm
	sacco grande 100 L / big bag 100 L
	230 €

## CA1602



CA1602

IT Carrelli portasacco con struttura a X - attacco rotondo da 120 L - coperchio in plastica rotondo con aggancio - ruote multidirezionali Ø 80 mm. Struttura verniciata e cestino per il CA1602 - struttura cromata e pedale per il CA1603. Sacco non incluso.

EN Bag holder trolleys with X structure - round fitting 120 L - round plastic lid with fastener. Available with basket and painted structure for CA1602 or with pedal control and chromed structure for CA1603. Bag not included.

## CA1603



CA1603

FR Chariots porte-sac en forme de X - Support rond 120 L - couvercle rond en plastique avec raccord. Disponible avec boîtier et structure peinte pour le CA1602 ou avec commande à pédale et structure chromée pour le CA1603. Sac non inclus.

DE Müllsackwagen mit X-Förmige Struktur - runder Anschluss 120 L - runder Kunststoffdeckel mit Aufhängung. Erhältlich mit Korb und lackierter Struktur für CA1602 oder mit Fußhebelöffnung und verchromter Struktur für CA1603. Sack nicht inbegriffen.

	CA1602
	58 x 56 x 102(h) cm
	230 €

	CA1603
	58 x 56 x 102(h) cm
	265 €

# AV4682



- IT Pattumiere in polietilene per raccolta differenziata - Struttura colore grigio - coperchio colorato a scelta. Ruote ø 143 mm.
- EN Polyethylene waste bins for differentiated collection - Grey structure - coloured lid of your choice. Wheels ø 143 mm.
- FR Poubelles en polyéthylène pour collecte différenciée - Structure de couleur grise - couvercle de couleur de votre choix. Roues ø 143 mm.
- DE Abfalleimer aus Polyethylen zur getrennten Entsorgung - graue Struktur - farbiger Deckel Ihrer Wahl. Räder ø 143 mm.

	AV4682Y giallo-yellow	AV4682R rosso-red	AV4682B blu-blue	AV4682G verde-green	AV4682W bianco-white
	54 x 49 x 85(h) cm				
	80 L				
	60 €				

# AV4674-75-76-78-79



- IT Pattumiere in polietilene. Diversi colori disponibili. Ruote ø 200 mm.
- EN Polyethylene waste bins. Several colours available. Wheels ø 200 mm.
- FR Poubelles en polyéthylène. Différentes couleurs disponibles. Roues ø 200 mm.
- DE Abfalleimer aus Polyethylen. Erhältlich in verschieden Farben. Räder ø 200 mm.

RC0075	
Pedale apricoperchio per contenitore - Pedal lid opener for container Pédale ouvre-couvercle pour conteneur - Deckelöffnungsfußhebel	
62 €	

	AV4674 bianco-white	AV4675 blu-blue	AV4676 verde-green	AV4678 giallo-yellow	AV4679 marrone brown
	55 x 48 x 93(h) cm				
	120 L				
	100 €				



# NEUTRO INOX

STEEL FURNITURE  
MADE IN ITALY





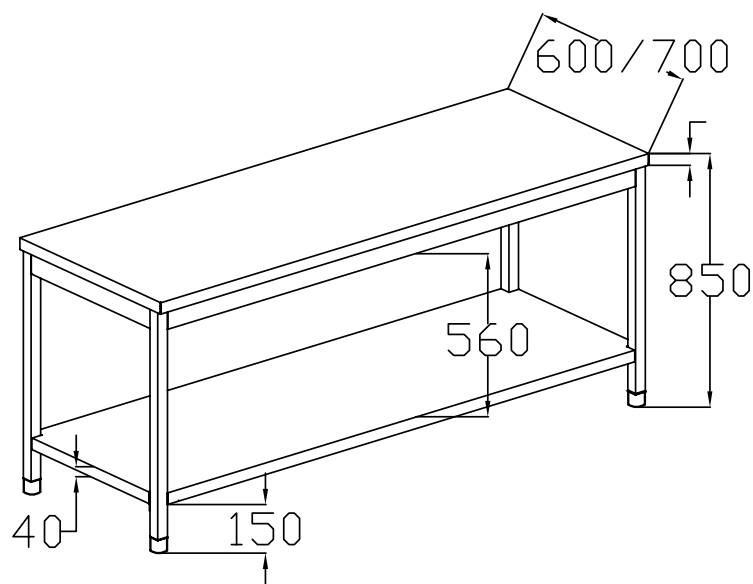

## IT Tavoli da lavoro su gambe con ripiano inferiore

Senza alzatina - profondità 600 o 700 mm. Struttura in acciaio inox - piano di lavoro in acciaio inox AISI 304 - piano di lavoro e ripiano inferiore piegati e saldati - ripiano inferiore con rinforzo ad omega - facile montaggio con viti incluse - piedini regolabili.



## EN Working Tables with undershelf

Without backsplash - depth 600 or 700 mm. Stainless steel structure - AISI 304 stainless steel working top - working top and bottom shelves folded and welded - bottom shelf with omega reinforcement crossbar - easy assembly with included screws - adjustable feet.

		 cm	 cm	 Kg	 Kg	
	GDATS66	60 x 60 x 85(h)	70 x 65 x 30(h) cm	17	27	290 €
	GDATS76	70 x 60 x 85(h)	80 x 65 x 30(h) cm	19	29	300 €
	GDATS86	80 x 60 x 85(h)	90 x 65 x 30(h) cm	20	30	320 €
	GDATS106	100 x 60 x 85(h)	110 x 65 x 30(h) cm	26	36	350 €
	GDATS126	120 x 60 x 85(h)	130 x 65 x 30(h) cm	31	41	385 €
	GDATS146	140 x 60 x 85(h)	130 x 65 x 30(h) cm	36	46	425 €
	GDATS156	150 x 60 x 85(h)	160 x 65 x 30(h) cm	38	48	445 €
	GDATS166	160 x 60 x 85(h)	170 x 65 x 30(h) cm	41	51	450 €
	GDATS186	180 x 60 x 85(h)	190 x 65 x 30(h) cm	45	55	485 €
	GDATS206	200 x 60 x 85(h)	210 x 65 x 30(h) cm	49	59	520 €
	GDATS67	60 x 70 x 85(h)	70 x 75 x 30(h) cm	18	28	305 €
	GDATS77	70 x 70 x 85(h)	80 x 75 x 30(h) cm	20	30	325 €
	GDATS87	80 x 70 x 85(h)	90 x 75 x 30(h) cm	22	32	340 €
	GDATS107	100 x 70 x 85(h)	110 x 75 x 30(h) cm	27	37	375 €
	GDATS127	120 x 70 x 85(h)	130 x 75 x 30(h) cm	33	43	410 €
	GDATS147	140 x 70 x 85(h)	130 x 75 x 30(h) cm	39	49	445 €
	GDATS157	150 x 70 x 85(h)	160 x 75 x 30(h) cm	42	52	470 €
	GDATS167	160 x 70 x 85(h)	170 x 75 x 30(h) cm	45	55	485 €
	GDATS187	180 x 70 x 85(h)	190 x 75 x 30(h) cm	51	61	520 €
	GDATS207	200 x 70 x 85(h)	210 x 65 x 30(h) cm	56	66	560 €

Tavoli da lavoro senza alzatina  
Working tables without backsplash

  
MADE IN ITALY





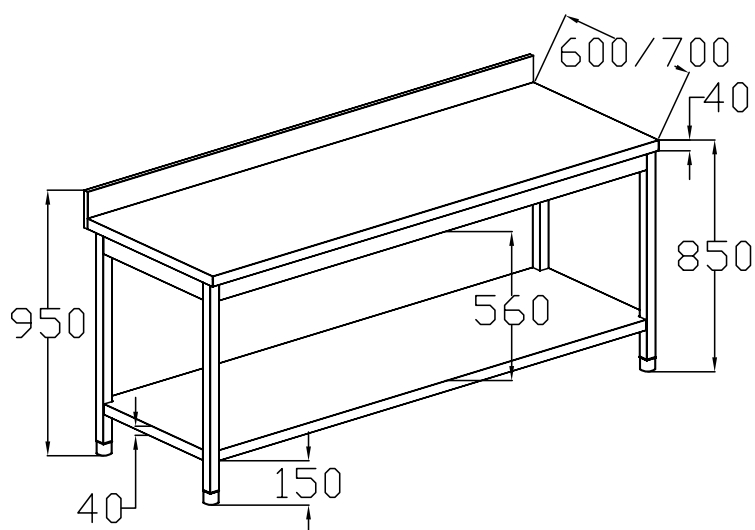

## IT Tavoli da lavoro su gambe con ripiano inferiore con alzatina

Con alzatina - profondità 600 o 700 mm. Struttura in acciaio inox - piano di lavoro in acciaio inox AISI 304 con alzatina tamburata h 100 mm. Piano di lavoro e ripiano inferiore piegati e saldati - ripiano inferiore con rinforzo ad omega - facile montaggio con viti incluse - piedini regolabili.



## EN Working tables with undershelf with backsplash

With backsplash - depth 600 or 700 mm. Stainless steel structure - AISI 304 stainless steel working top with h 100 mm, hollow-core backsplash. Working top and bottom shelves folded and welded - bottom shelf with omega reinforcement crossbar - easy assembly with included screws - adjustable feet.

		 cm	 cm	 Kg	 Kg	
	GDATS66A	60 x 60 x 95(h)	70 x 65 x 30(h) cm	18	28	310 €
	GDATS76A	70 x 60 x 95(h)	80 x 65 x 30(h) cm	20	30	320 €
	GDATS86A	80 x 60 x 95(h)	90 x 65 x 30(h) cm	21	31	345 €
	GDATS106A	100 x 60 x 95(h)	110 x 65 x 30(h) cm	27	37	375 €
	GDATS126A	120 x 60 x 95(h)	130 x 65 x 30(h) cm	32	42	415 €
	GDATS146A	140 x 60 x 95(h)	150 x 65 x 30(h) cm	37	47	450 €
	GDATS156A	150 x 60 x 95(h)	160 x 65 x 30(h) cm	40	50	475 €
	GDATS166A	160 x 60 x 95(h)	170 x 65 x 30(h) cm	43	53	490 €
	GDATS186A	180 x 60 x 95(h)	190 x 65 x 30(h) cm	47	57	525 €
	GDATS206A	200 x 60 x 95(h)	210 x 65 x 30(h) cm	52	62	560 €
	GDATS67A	60 x 70 x 95(h)	70 x 75 x 30(h) cm	21	31	320 €
	GDATS77A	70 x 70 x 95(h)	80 x 75 x 30(h) cm	23	33	335 €
	GDATS87A	80 x 70 x 95(h)	90 x 75 x 30(h) cm	25	35	360 €
	GDATS107A	100 x 70 x 95(h)	110 x 75 x 30(h) cm	32	42	395 €
	GDATS127A	120 x 70 x 95(h)	130 x 75 x 30(h) cm	38	48	435 €
	GDATS147A	140 x 70 x 95(h)	160 x 75 x 30(h) cm	44	54	475 €
	GDATS157A	150 x 70 x 95(h)	160 x 75 x 30(h) cm	47	57	505 €
	GDATS167A	160 x 70 x 95(h)	170 x 75 x 30(h) cm	50	60	515 €
	GDATS187A	180 x 70 x 95(h)	190 x 75 x 30(h) cm	56	66	560 €
	GDATS207A	200 x 70 x 95(h)	210 x 65 x 30(h) cm	61	71	600 €

## IT Cassettiere per tavoli inox

Cassettiere da agganciare a tavoli inox ad uno, due o tre cassetti.

## EN Stainless steel drawers units

Drawer units for stainless steel tables with one, two or three drawers.



		Cassetti Drawers	 cm	 cm	 Kg	 Kg	
	ACCASGDATS6130	1	30 x 58 x 13(h)	40 x 68 x 25(h) cm	6	16	300 €
	ACCASGDATS6140	1	40 x 58 x 13(h)	50 x 68 x 25(h) cm	8	18	320 €
	ACCASGDATS6150	1	50 x 58 x 13(h)	60 x 68 x 25(h) cm	10	20	335 €
	ACCASGDATS6240	2	40 x 58 x 54(h)	50 x 68 x 70(h) cm	26	36	720 €
	ACCASGDATS6250	2	50 x 58 x 54(h)	60 x 68 x 70(h) cm	28	38	790 €
	ACCASGDATS6340	3	40 x 58 x 54(h)	50 x 68 x 70(h) cm	30	40	755 €
	ACCASGDATS6350	3	50 x 58 x 54(h)	60 x 68 x 70(h) cm	36	46	830 €
	ACCASGDATS7130	1	30 x 68 x 13(h)	40 x 78 x 25(h) cm	7	17	330 €
	ACCASGDATS7140	1	40 x 68 x 13(h)	50 x 78 x 25(h) cm	9	19	350 €
	ACCASGDATS7150	1	50 x 68 x 13(h)	60 x 78 x 25(h) cm	11	21	370 €
	ACCASGDATS7240	2	40 x 68 x 54(h)	50 x 78 x 70(h) cm	30	40	755 €
	ACCASGDATS7250	2	50 x 68 x 54(h)	60 x 78 x 70(h) cm	32	42	825 €
	ACCASGDATS7340	3	40 x 68 x 54(h)	50 x 78 x 70(h) cm	32	42	795 €
	ACCASGDATS7350	3	50 x 68 x 54(h)	60 x 78 x 70(h) cm	37	47	870 €



Cassettiere in acciaio inox  
Stainless steel drawer units



MADE IN ITALY





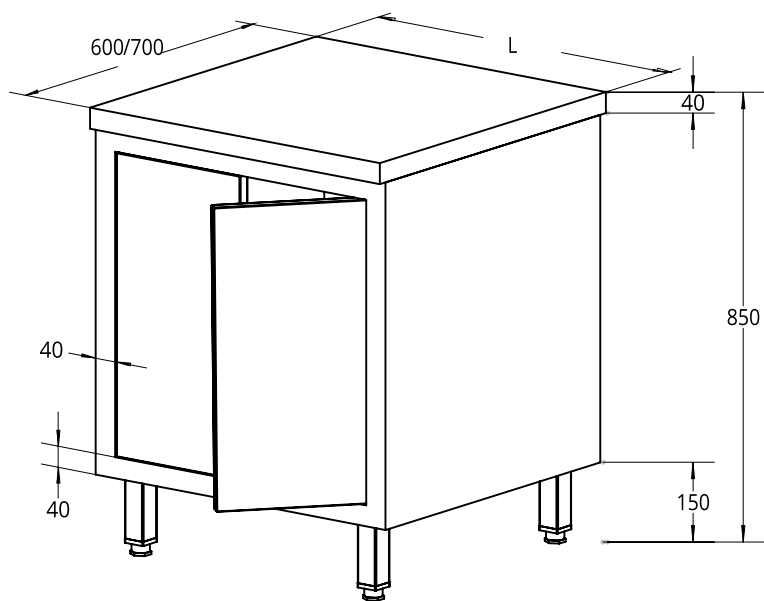

## IT Tavoli armadiati con porte battenti

Senza alzatina - profondità 600 o 700 mm. Struttura in acciaio inox - piano di lavoro in acciaio inox AISI 304 - ripiano intermedio regolabile con rinforzo ad omega - porte tamburate - pannello posteriore in acciaio Inox - piedini regolabili.



## EN Working cabinets with hinged doors

Without backsplash - depth 600 or 700 mm. Stainless steel structure - AISI 304 Stainless steel working top - adjustable middle shelf with omega reinforcement crossbar - hollow core doors - Stainless steel back panel - adjustable feet.

		 cm	 cm	 Kg	 Kg	
 60	GDA SR66	60 x 60 x 85(h)	70 x 70 x 1050(h) cm	55	65	570 €
	GDA SR86	80 x 60 x 85(h)	90 x 70 x 105(h) cm	60	70	605 €
 70	GDA SR67	60 x 70 x 85(h)	70 x 80 x 105(h) cm	58	68	595 €
	GDA SR87	80 x 70 x 85(h)	90 x 80 x 105(h) cm	61	71	625 €

### OPTIONAL

RUO100
kit 4 ruote / 4 wheel ø100
80 €

## IT Tavoli armadiati con porte scorrevoli

Senza alzatina - profondità 600 o 700 mm. Struttura in acciaio inox - piano di lavoro in acciaio inox AISI 304 - ripiano intermedio regolabile con rinforzo ad omega - porte tamburate - pannello posteriore in acciaio inox - piedini regolabili.

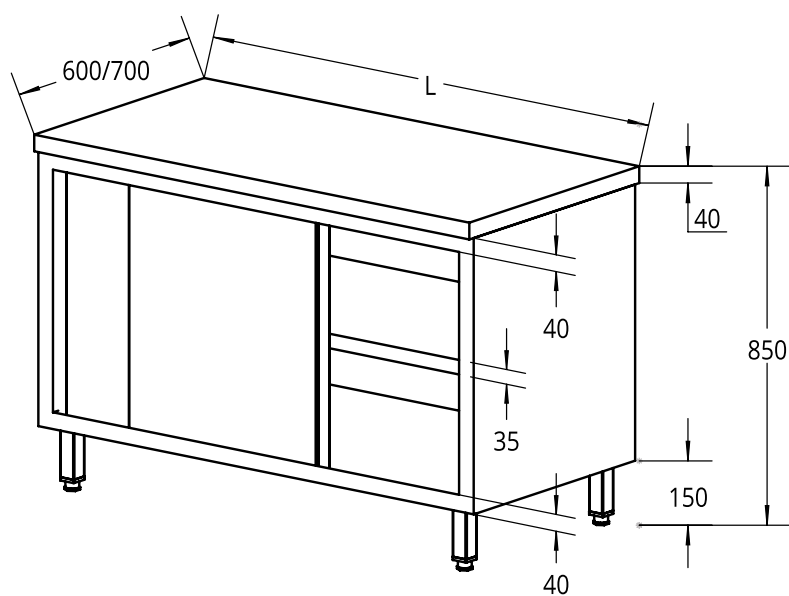

## EN Working cabinets with sliding doors

Without backsplash - depth 600 or 700 mm. Stainless steel structure - AISI 304 Stainless steel working top - adjustable middle shelf with omega reinforcement crossbar - hollow core doors - Stainless steel back panel - adjustable feet.

		 cm	 cm	 Kg	 Kg	
	GDASR106	100 x 60 x 85(h)	110 x 70 x 105(h) cm	69	79	670 €
	GDASR126	120 x 60 x 85(h)	130 x 70 x 105(h) cm	75	85	750 €
	GDASR146	140 x 60 x 85(h)	150 x 70 x 105(h) cm	84	94	810 €
	GDASR156	150 x 60 x 85(h)	160 x 70 x 105(h) cm	88	98	835 €
	GDASR166	160 x 60 x 85(h)	170 x 70 x 105(h) cm	92	102	865 €
	GDASR186	180 x 60 x 85(h)	190 x 70 x 105(h) cm	100	110	970 €
	GDASR206	200 x 60 x 85(h)	210 x 70 x 105(h) cm	106	116	1.040 €
	GDASR107	100 x 70 x 85(h)	110 x 80 x 105(h) cm	72	82	695 €
	GDASR127	120 x 70 x 85(h)	130 x 80 x 105(h) cm	80	90	775 €
	GDASR147	140 x 70 x 85(h)	150 x 80 x 105(h) cm	88	98	835 €
	GDASR157	150 x 70 x 85(h)	160 x 80 x 105(h) cm	92	102	865 €
	GDASR167	160 x 70 x 85(h)	170 x 80 x 105(h) cm	96	106	900 €
	GDASR187	180 x 70 x 85(h)	190 x 80 x 105(h) cm	108	118	1.000 €
	GDASR207	200 x 70 x 85(h)	210 x 80 x 105(h) cm	118	128	1.080 €

### OPTIONAL

<b>RUO100</b>
kit 4 ruote / 4 wheel ø100
<b>80 €</b>



MADE IN ITALY





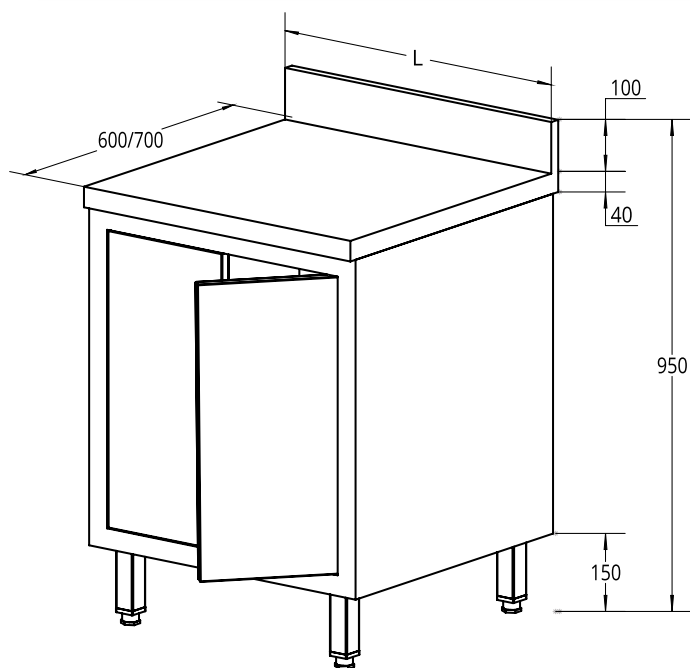

## IT Tavoli armadiati con porte battenti con alzatina

Con alzatina - profondità 600 o 700 mm. Struttura in acciaio inox - piano di lavoro in acciaio inox AISI 304 - ripiano intermedio regolabile con rinforzo ad omega - alzatina h 100 mm tamburata - porte tamburate - pannello posteriore in acciaio Inox - piedini regolabili.



## EN Working cabinets with hinged doors with backsplash

With backsplash - depth 600 or 700 mm. Stainless steel structure - AISI 304 stainless steel working top - adjustable middle shelf with omega reinforcement crossbar - h 100 mm hollow-core backsplash - hollow core doors - Stainless steel back panel - adjustable feet.

						
		cm	cm	Kg	Kg	
	GDASR66A	60 x 60 x 95(h)	70 x 70 x 115(h) cm	56	66	595 €
	GDASR86A	80 x 60 x 95(h)	90 x 70 x 115(h) cm	61	71	630 €
	GDASR67A	60 x 70 x 95(h)	70 x 80 x 115(h) cm	59	69	610 €
	GDASR87A	80 x 70 x 95(h)	90 x 80 x 115(h) cm	63	73	655 €

### OPTIONAL

<b>RUO100</b>
kit 4 ruote / 4 wheel ø100
<b>80 €</b>

## IT Tavoli armadiati con porte scorrevoli con alzatina

Con alzatina - profondità 600 o 700 mm. Struttura in acciaio inox - piano di lavoro in acciaio inox AISI 304 - ripiano intermedio regolabile con rinforzo ad omega - alzatina h 100 mm tamburata - porte tamburate - pannello posteriore in acciaio Inox - piedini regolabili.

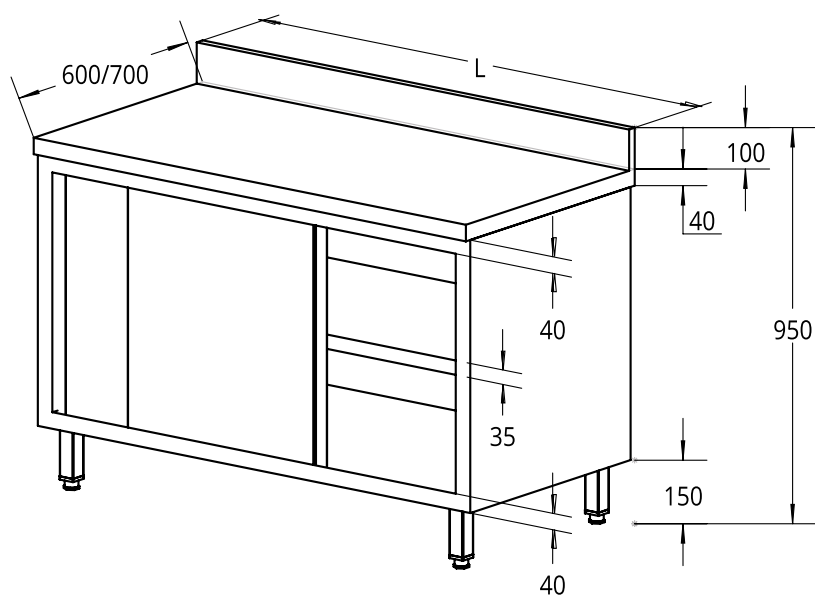

## EN Working cabinets with sliding doors with backsplash

With backsplash - depth 600 or 700 mm. Stainless steel structure - AISI 304 stainless steel working top - adjustable middle shelf with omega reinforcement crossbar - h 100 mm hollow-core backsplash - hollow core doors - Stainless steel back panel - adjustable feet.

		 cm	 cm	 NET Kg	 GROSS Kg	
	GDASR106A	100 x 60 x 95(h)	110 x 70 x 115(h) cm	70	80	705 €
	GDASR126A	120 x 60 x 95(h)	130 x 70 x 115(h) cm	76	86	785 €
	GDASR146A	140 x 60 x 95(h)	150 x 70 x 115(h) cm	85	95	845 €
	GDASR156A	150 x 60 x 95(h)	160 x 70 x 115(h) cm	89	99	890 €
	GDASR166A	160 x 60 x 95(h)	170 x 70 x 115(h) cm	93	103	930 €
	GDASR186A	180 x 60 x 95(h)	190 x 70 x 115(h) cm	101	111	1.020 €
	GDASR206A	200 x 60 x 95(h)	210 x 70 x 115(h) cm	107	117	1.095 €
	GDASR107A	100 x 70 x 95(h)	110 x 80 x 115(h) cm	74	84	730 €
	GDASR127A	120 x 70 x 95(h)	130 x 80 x 115(h) cm	82	92	810 €
	GDASR147A	140 x 70 x 95(h)	150 x 80 x 115(h) cm	90	100	875 €
	GDASR157A	150 x 70 x 95(h)	160 x 80 x 115(h) cm	94	104	925 €
	GDASR167A	160 x 70 x 95(h)	170 x 80 x 115(h) cm	98	108	945 €
	GDASR187A	180 x 70 x 95(h)	190 x 80 x 115(h) cm	110	120	1.055 €
	GDASR207A	200 x 70 x 95(h)	210 x 80 x 115(h) cm	120	160	1.135 €

### OPTIONAL

RUO100
kit 4 ruote / 4 wheel ø100
80 €







MADE IN ITALY

## IT Tavoli armadiati ad angolo

Senza alzatina o con alzatina - struttura in acciaio inox - piano di lavoro in acciaio inox AISI 304 - ripiano intermedio regolabile con rinforzo ad omega - alzatina h 100 mm tamburata - porte tamburate - pannello posteriore in acciaio Inox - piedini regolabili.

## EN Working corner cabinets

Without backsplash or with backsplash - stainless steel structure - AISI 304 stainless steel working top - adjustable middle shelf with omega reinforcement crossbar - h 100 mm hollow-core backsplash - hollow core doors - Stainless steel back panel - adjustable feet.

					
GDCC996	90 x 90 x 60 x 85(h)	100 x 100 x 105(h) cm	75	85	805 €
GDCC10107	100 x 100 x 70 x 85(h)	110 x 100 x 105(h) cm	89	99	855 €
con alzatina - with backsplash					
GDCC996A	90 x 90 x 60 x 95(h)	100 x 100 x 105(h) cm	77	87	870 €
GDCC10107A	100 x 100 x 70 x 95(h)	110 x 100 x 115(h) cm	91	101	925 €

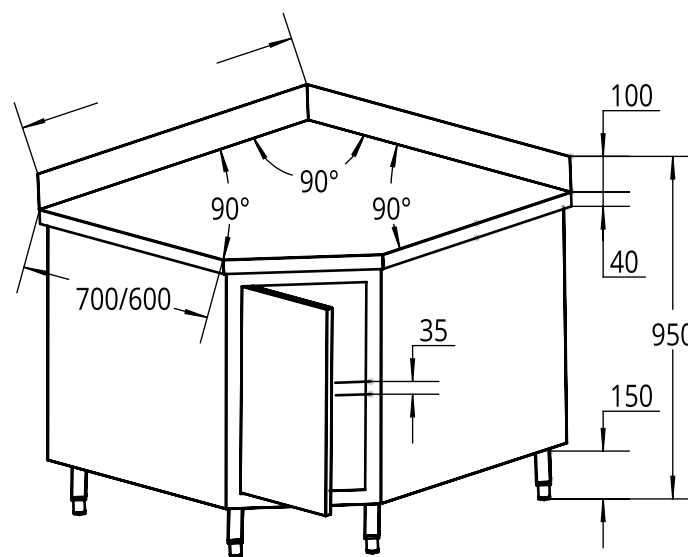
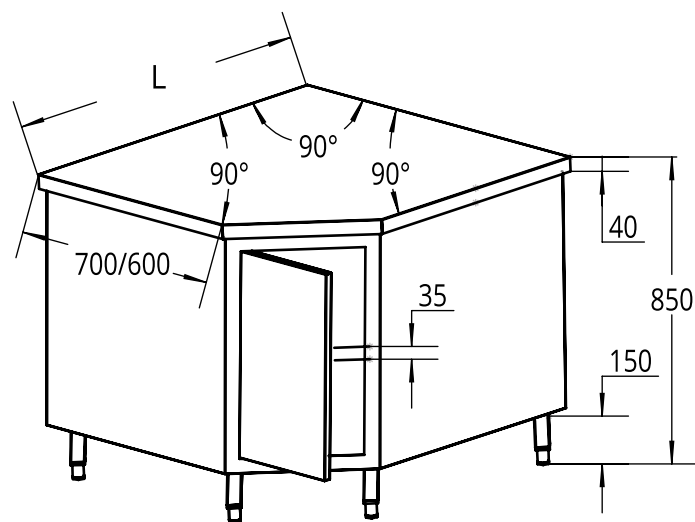

## IT Armadi in acciaio inossidabile con ante scorrevoli

Profondità 600 o 700 mm. Struttura in acciaio inox - ripiano intermedio regolabile con rinforzo ad omega - porte tamburate - pannello posteriore in acciaio Inox - piedini regolabili.

## EN Sliding doors stainless steel cabinets

Depth 600 or 700 mm. Stainless steel structure - adjustable middle shelf with omega reinforcement crossbar - hollow core doors - Stainless steel back panel adjustable feet.



COMPRESI 3 RIPIANI  
3 SHELF INCLUDED

		cm	cm	Kg	Kg	
 60	GDSCS126	120 x 60 x 180(h)	130 x 70 x 200(h)	109	119	1.590 €
	GDSCS146	140 x 60 x 180(h)	150 x 70 x 200(h)	122	132	1.715 €
	GDSCS166	160 x 60 x 180(h)	170 x 70 x 200(h)	142	152	1.840 €
 70	GDSCS127	120 x 70 x 180(h)	130 x 80 x 200(h)	147	157	1.640 €
	GDSCS147	140 x 70 x 180(h)	150 x 80 x 200(h)	155	165	1.770 €
	GDSCS167	160 x 70 x 180(h)	170 x 80 x 200(h)	183	193	1.895 €

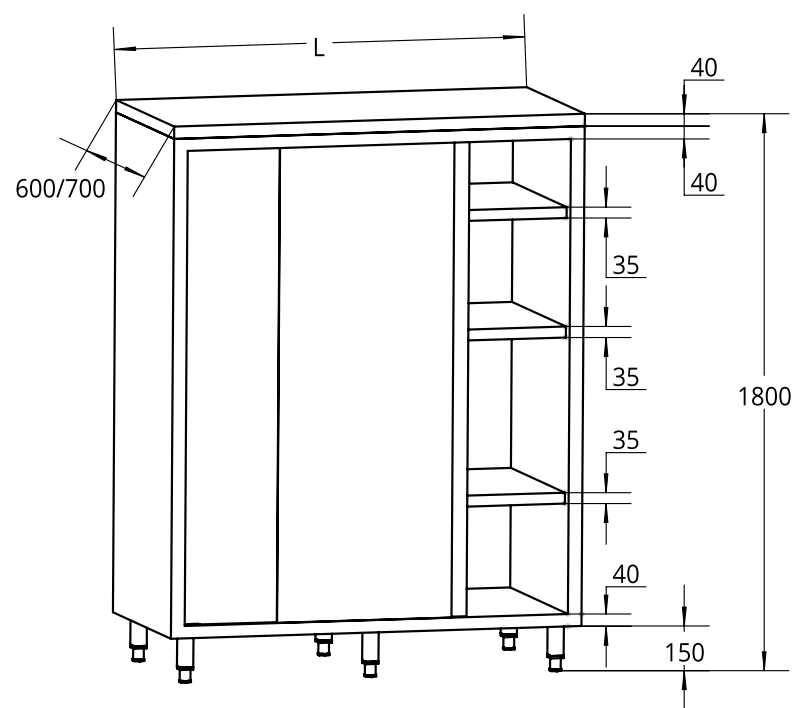

### OPTIONAL RIPIANO / SHELF

	cm			cm	
SHELF126	120 x 60	125 €	SHELF127	120 x 70	125 €
SHELF146	140 x 60	145 €	SHELF147	140 x 70	150 €
SHELF166	160 x 60	180 €	SHELF167	160 x 70	185 €

Armadi in acciaio inossidabile con ante scorrevoli  
Sliding doors stainless steel cabinets

MADE IN ITALY





## IT Pensili con ante a battente

Struttura in acciaio inox - ripiano intermedio regolabile con rinforzo ad omega - porte tamburate - staffe di montaggio a muro incluse.

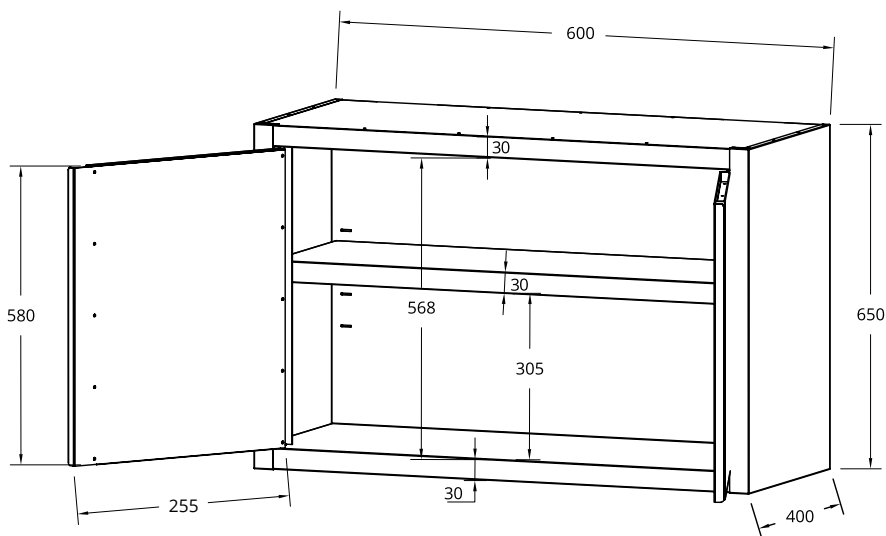
## EN Hinged doors wall cupboards

Stainless steel structure - adjustable middle shelf with omega reinforcement crossbar - hollow core doors - wall mounting racks included.



	 cm	 cm	 Kg	 Kg	
GDWCH64	60 x 40 x 65(h)	70 x 50 x 85(h) cm	17	27	380 €
GDWCH84	80 x 40 x 65(h)	90 x 50 x 85(h) cm	19	29	395 €





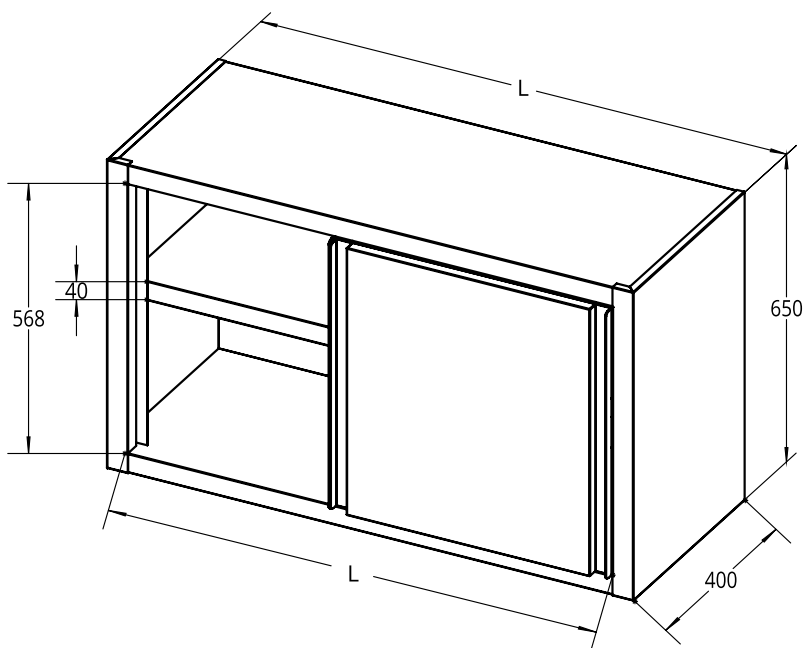

## IT Pensili con ante scorrevoli

Struttura in acciaio inox - ripiano intermedio regolabile con rinforzo ad omega - porte tamburate - staffe di montaggio a muro incluse.



## EN Sliding doors wall cupboards

Stainless Steel Structure - adjustable middle shelf with omega reinforcement crossbar - hollow core doors - wall mounting racks included.

	 cm	 cm	 NET Kg	 GROSS Kg	
GDWCS104	100 x 40 x 65(h)	110 x 50 x 85(h) cm	26	36	420 €
GDWCS124	120 x 40 x 65(h)	130 x 50 x 85(h) cm	30	40	465 €
GDWCS144	140 x 40 x 65(h)	150 x 50 x 85(h) cm	34	44	510 €
GDWCS164	160 x 40 x 65(h)	170 x 50 x 85(h) cm	38	48	590 €
GDWCS184	180 x 40 x 65(h)	190 x 50 x 85(h) cm	44	54	640 €
GDWCS204	200 x 40 x 65(h)	210 x 50 x 85(h) cm	49	59	690 €



MADE IN ITALY



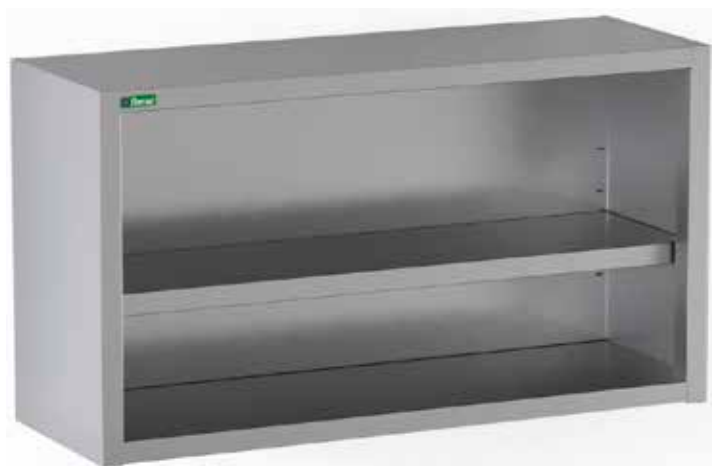

## IT Pensili aperti

Struttura in acciaio inox - ripiano intermedio regolabile con rinforzo ad omega - staffe di montaggio a muro incluse.



## EN Open wall cupboards

Stainless steel structure - adjustable middle shelf with omega reinforcement crossbar - wall mounting racks included.

	 cm	 cm	 NET Kg	 GROSS Kg	
GDWCO64	60 x 40 x 65(h)	70 x 50 x 85(h) cm	16	26	270 €
GDWCO84	80 x 40 x 65(h)	90 x 50 x 85(h) cm	18	28	280 €
GDWCO104	100 x 40 x 65(h)	110 x 50 x 85(h) cm	20	30	315 €
GDWCO124	120 x 40 x 65(h)	130 x 50 x 85(h) cm	22	32	350 €
GDWCO144	140 x 40 x 65(h)	150 x 50 x 85(h) cm	24	34	385 €
GDWCO164	160 x 40 x 65(h)	170 x 50 x 85(h) cm	26	36	430 €
GDWCO184	180 x 40 x 65(h)	180 x 50 x 85(h) cm	28	38	470 €
GDWCO204	200 x 40 x 65(h)	210 x 50 x 85(h) cm	30	40	525 €

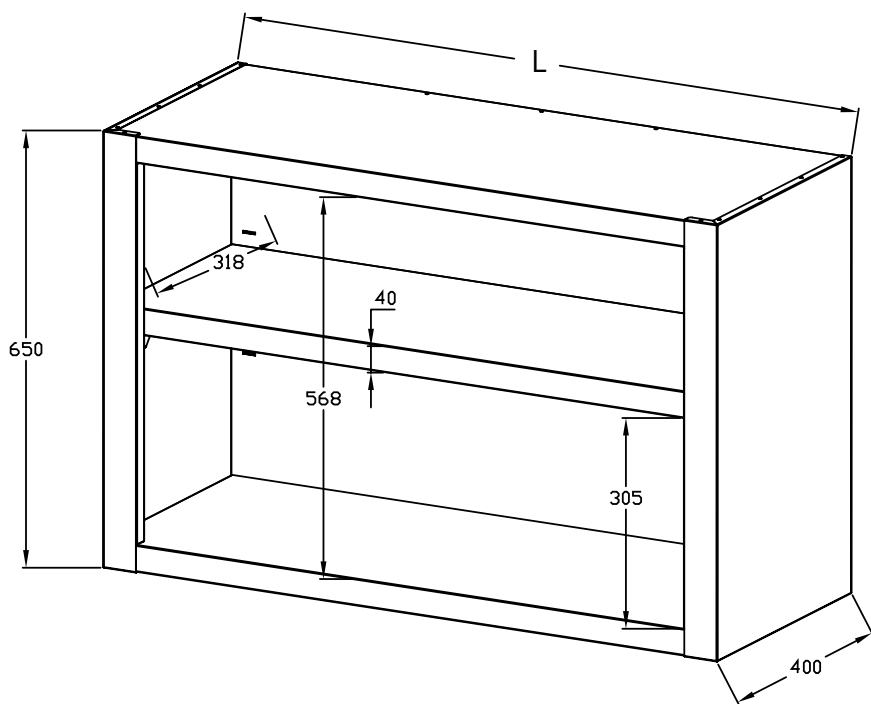

## IT Mensole in acciaio inox

Struttura in acciaio inox - profondità ripiano 300 mm o 400 mm - alzatina posteriore h 30 mm staffe montaggio a muro incluse h 400 mm. Le staffe possono essere sovrapposte per ottenere più livelli.

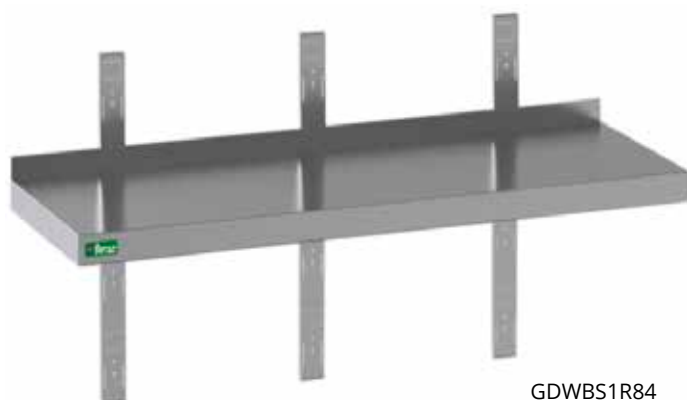

GDWBS1R84

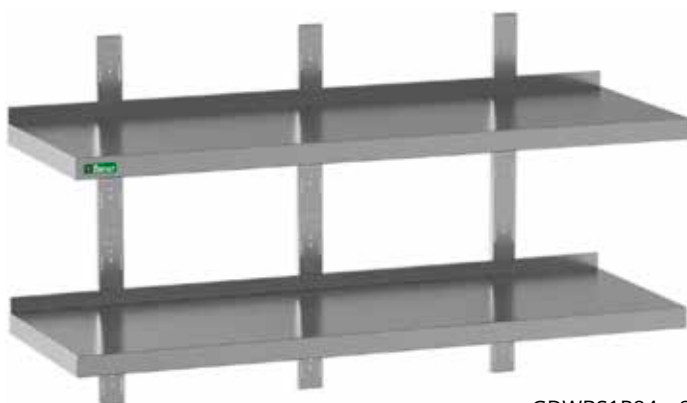

GDWBS1R84 x 2

## EN Stainless steel shelves

Stainless steel structure - shelf depth 300 mm or 400 mm - backplash h 30 mm - wall mounting racks h 400 mm included - racks can be stacked to obtain multiple levels.

						
		cm	cm	Kg	Kg	
30	GDWB S1R63	60 x 30 x 40(h)	66 x 45 x 10(h) cm	2	7	85 €
	GDWB S1R83	80 x 30 x 40(h)	86 x 45 x 10(h) cm	2	7	95 €
	GDWB S1R103	100 x 30 x 40(h)	106 x 45 x 10(h) cm	3	8	100 €
	GDWB S1R123	120 x 30 x 40(h)	126 x 45 x 10(h) cm	4	9	125 €
	GDWB S1R143	140 x 30 x 40(h)	146 x 45 x 10(h) cm	4	9	135 €
	GDWB S1R163	160 x 30 x 40(h)	166 x 45 x 10(h) cm	5	10	155 €
	GDWB S1R183	180 x 30 x 40(h)	186 x 45 x 10(h) cm	5	10	175 €
	GDWB S1R203	200 x 30 x 40(h)	206 x 45 x 10(h) cm	6	11	205 €
40	GDWB S1R64	60 x 40 x 40(h)	66 x 55 x 10(h) cm	2	7	95 €
	GDWB S1R84	80 x 40 x 40(h)	96 x 55 x 10(h) cm	2	7	105 €
	GDWB S1R104	100 x 40 x 40(h)	106 x 55 x 10(h) cm	3	8	110 €
	GDWB S1R124	120 x 40 x 40(h)	126 x 55 x 10(h) cm	4	9	145 €
	GDWB S1R144	140 x 40 x 40(h)	146 x 55 x 10(h) cm	4	9	155 €
	GDWB S1R164	160 x 40 x 40(h)	166 x 55 x 10(h) cm	5	10	185 €
	GDWB S1R184	180 x 40 x 40(h)	186 x 55 x 10(h) cm	5	10	195 €
	GDWB S1R204	200 x 40 x 40(h)	206 x 55 x 10(h) cm	6	11	230 €

Mensole in acciaio inox  
Stainless steel shelves







  
MADE IN ITALY

## IT Lavelli a sbalzo - 1 vasca

Struttura in acciaio Inox - piano e vasca in acciaio inox AISI 304 - ripiano inferiore con rinforzo ad omega - alzatina h 100 mm - piedini regolabili - piletta scarico e troppo pieno inclusi.

## EN Single sink unit for built-in dishwasher

Stainless steel structure - top and bowl in stainless steel AISI 304 - bottom shelf with omega reinforcement crossbar - h 100 mm backsplash - adjustable feet - drain and overflow drain included.

		 cm	 cm	 Kg	 Kg	 N.	
 cm 70	GDS127L1DW	120 x 70 x 95(h)	130 x 80 x 60(h) cm	33	43	1 SX/L - 50 x 50 x 30	710 €
	GDS127R1DW	120 x 70 x 95(h)	130 x 80 x 60(h) cm	33	43	1 DX/R - 50 x 50 x 30	710 €
	GDS147L1DW	140 x 70 x 95(h)	150 x 80 x 60(h) cm	35	45	1 SX/L - 60 x 50 x 30	760 €
	GDS147R1DW	140 x 70 x 95(h)	150 x 80 x 60(h) cm	35	45	1 DX/R - 60 x 50 x 30	760 €

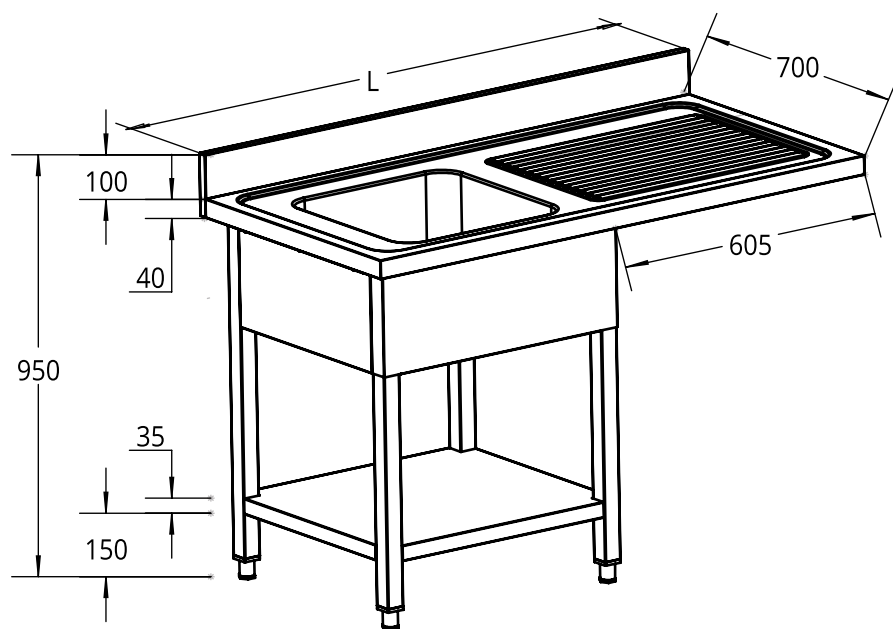







## IT Lavelli a sbalzo - 2 vasche

Struttura in acciaio Inox - piano e vasche in acciaio inox AISI 304 - ripiano inferiore con rinforzo ad omega - alzatina h 100 mm - piedini regolabili - piletta scarico e troppo pieno inclusi.

## EN Double sink unit for built-in dishwasher

Stainless steel structure - top and bowls in stainless steel AISI 304 - bottom shelf with omega reinforcement crossbar - h 100 mm backsplash - adjustable feet - drain and overflow drain included.

							
		cm	cm	Kg	Kg	N.	
 70	GDS167L2DW	160 x 70 x 95(h)	170 x 80 x 60(h) cm	41	51	2 SX/L - 50 x 40 x 30	925 €
	GDS167R2DW	160 x 70 x 95(h)	170 x 80 x 60(h) cm	41	51	2 DX/R - 50 x 40 x 30	925 €
	GDS187L2DW	180 x 70 x 95(h)	190 x 80 x 60(h) cm	45	55	2 SX/L - 50 x 50 x 30	1.000 €
	GDS187R2DW	180 x 70 x 95(h)	190 x 80 x 60(h) cm	45	55	2 DX/R - 50 x 50 x 30	1.000 €

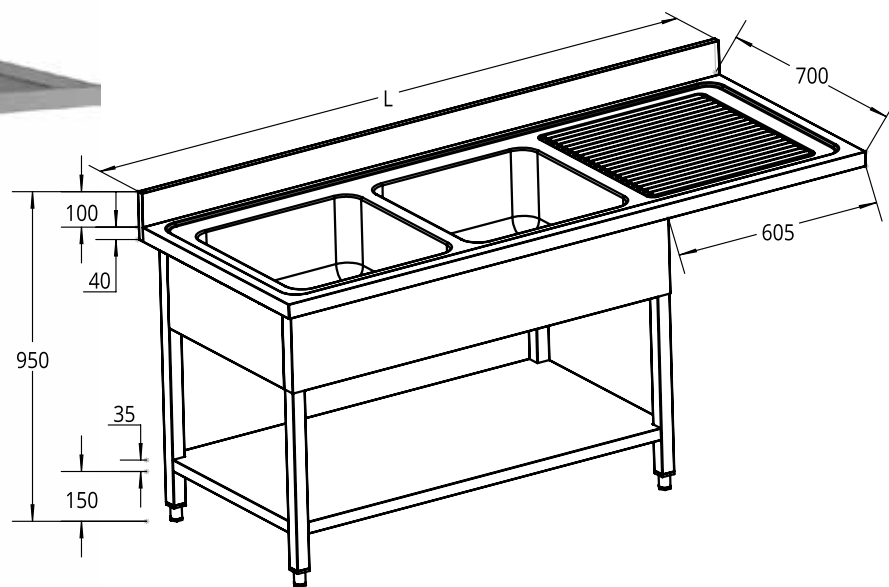

Lavelli a sbalzo - 2 vasche con sgocciolatoio  
Double sink unit for built-in dishwasher with drainer







  
MADE IN ITALY

## IT Lavelli aperti - 2 vasche

Con ripiano inferiore e sgocciolatoio - profondità 600 mm - struttura in acciaio inox - piano e vasche in acciaio inox AISI 304 - ripiano inferiore con rinforzo ad omega - alzata h 100 mm - piedini regolabili - piletta scarico e troppo pieno inclusi.

## EN Two bowls sinks

With bottom shelf and drainer - depth 600 mm - stainless steel structure - top and bowls in stainless steel AISI 304 - bottom shelf with omega reinforcement crossbar - h 100 mm backsplash - adjustable feet - drain and overflow drain included.

							
		cm	cm	Kg	Kg	N.	
 60	GD166BL2	160 x 60 x 95(h)	170 x 70 x 60(h) cm	50	60	2 SX/L - 50 x 40 x 30	995 €
	GD166BR2	160 x 60 x 95(h)	170 x 70 x 60(h) cm	50	60	2 DX/R - 50 x 40 x 30	995 €
	GD186BL2	180 x 60 x 95(h)	190 x 70 x 60(h) cm	55	65	2 SX/L - 50 x 40 x 30	1.085 €
	GD186BR2	180 x 60 x 95(h)	190 x 70 x 60(h) cm	55	65	2 DX/R - 50 x 40 x 30	1.085 €
	GD206BM2	200 x 60 x 95(h)	210 x 70 x 60(h) cm	59	69	centrali / central 50 x 40 x 30	1.250 €

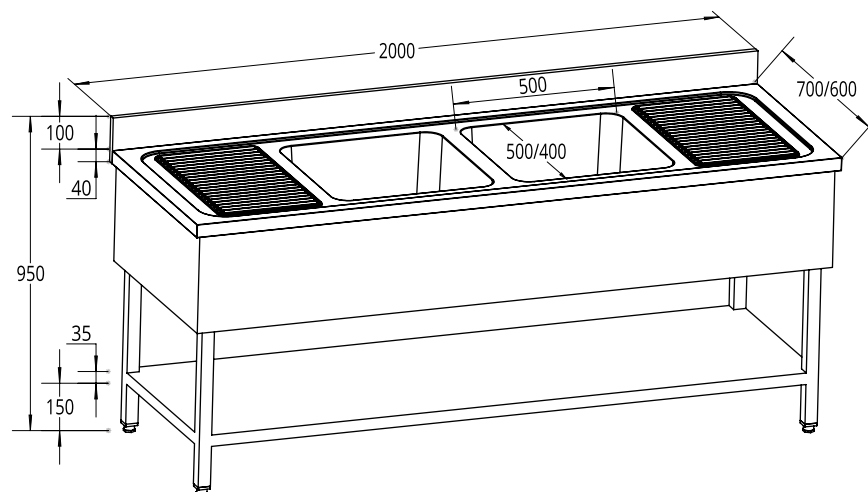







## IT Lavelli aperti - 2 vasche

Con ripiano inferiore e sgocciolatoio - profondità 700 mm - struttura in acciaio inox - piano e vasche in acciaio inox AISI 304 - ripiano inferiore con rinforzo ad omega - alzatina h 100 mm - piedini regolabili - piletta scarico e troppo pieno inclusi.

## EN Two bowls sinks

With bottom shelf and drainer - depth 700 mm - stainless steel structure - top and bowls in stainless steel AISI 304 - bottom shelf with omega reinforcement crossbar - h 100 mm backsplash - adjustable feet - drain and overflow drain included.

							
		cm	cm	Kg	Kg	N.	
 70	GD167BL2	160 x 70 x 95(h)	170 x 80 x 60(h) cm	55	65	2 SX/L - 50 x 50 x 30	1.035 €
	GD167BR2	160 x 70 x 95(h)	170 x 80 x 60(h) cm	55	65	2 DX/R - 50 x 50 x 30	1.035 €
	GD187BL2	180 x 70 x 95(h)	190 x 80 x 60(h) cm	60	70	2 SX/L - 50 x 50 x 30	1.100 €
	GD187BR2	180 x 70 x 95(h)	190 x 80 x 60(h) cm	60	70	2 DX/R - 50 x 50 x 30	1.100 €
	GD207BM2	200 x 70 x 95(h)	210 x 80 x 60(h) cm	65	75	centrali / central 60 x 50 x 30	1.330 €

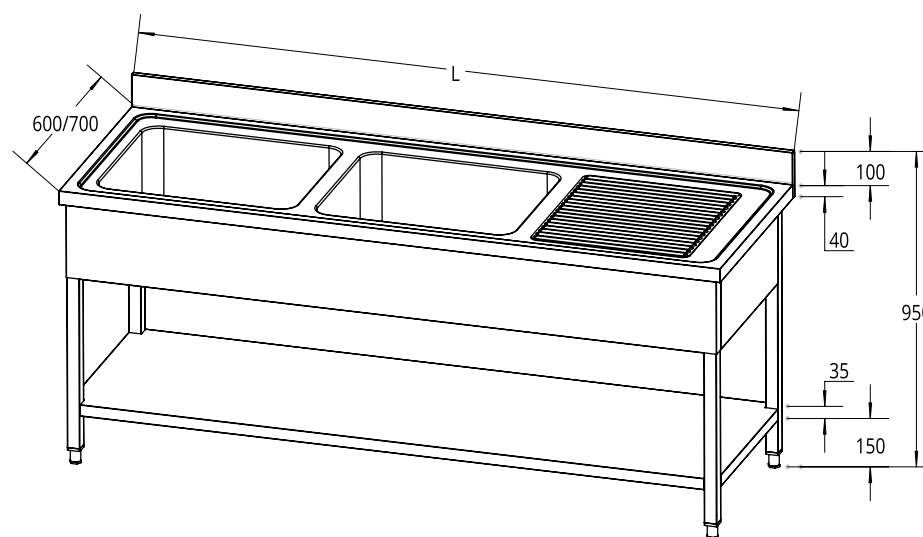









## IT Lavelli aperti - 1 vasca

Con ripiano inferiore e sgocciolatoio - profondità 600 o 700 mm - struttura in acciaio Inox - piano e vasca in acciaio inox AISI 304 - ripiano inferiore con rinforzo ad omega - alzatina h 100 mm - piedini regolabili - piletta scarico e troppo pieno inclusi.

## EN One bowl sinks

With bottom shelf and drainer - depth 600 or 700 mm - stainless steel structure - top and bowl in stainless steel AISI 304 - bottom shelf with omega reinforcement crossbar - h 100 mm backsplash - adjustable feet - drain and overflow drain included.

							
		cm	cm	Kg	Kg	N.	
	GD106BL1	100 x 60 x 95(h)	110 x 70 x 60(h) cm	40	50	1 SX/L - 40 x 40 x 30	620 €
	GD106BR1	100 x 60 x 95(h)	110 x 70 x 60(h) cm	40	50	1 DX/R - 40 x 40 x 30	620 €
	GD126BL1	120 x 60 x 95(h)	130 x 70 x 60(h) cm	42	52	1 SX/L - 50 x 40 x 30	745 €
	GD126BR1	120 x 60 x 95(h)	130 x 70 x 60(h) cm	42	52	1 DX/R - 50 x 40 x 30	745 €
	GD146BL1	140 x 60 x 95(h)	150 x 70 x 60(h) cm	47	57	1 SX/L - 50 x 40 x 30	810 €
	GD146BR1	140 x 60 x 95(h)	150 x 70 x 60(h) cm	47	57	1 DX/R - 50 x 40 x 30	810 €
	GD107BL1	100 x 70 x 95(h)	110 x 80 x 60(h) cm	43	53	1 SX/L - 50 x 40 x 30	735 €
	GD107BR1	100 x 70 x 95(h)	110 x 80 x 60(h) cm	43	53	1 DX/R - 50 x 40 x 30	735 €
	GD127BL1	120 x 70 x 95(h)	130 x 80 x 60(h) cm	45	55	1 SX/L - 50 x 50 x 30	780 €
	GD127BR1	120 x 70 x 95(h)	130 x 80 x 60(h) cm	45	55	1 DX/R - 50 x 50 x 30	780 €
	GD147BL1	140 x 70 x 95(h)	150 x 80 x 60(h) cm	54	64	1 SX/L - 60 x 50 x 30	835 €
	GD147BR1	140 x 70 x 95(h)	150 x 80 x 60(h) cm	54	64	1 DX/R - 60 x 50 x 30	835 €

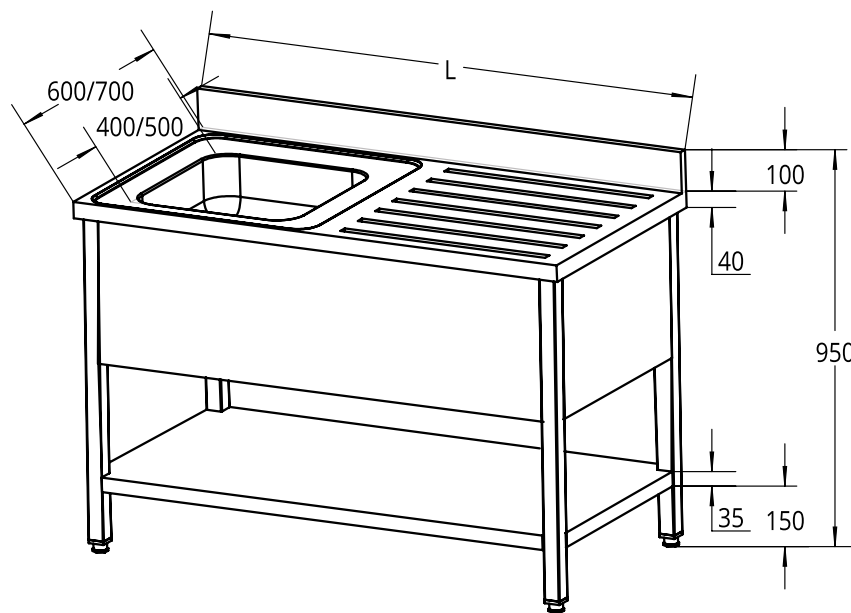







## IT Lavelli aperti - 1 vasca

Senza sgocciolatoio con ripiano inferiore - profondità 700 mm - struttura in acciaio inox - piano e vasca in acciaio inox AISI 304 - ripiano inferiore con rinforzo ad omega - alzatina h 100 mm - piedini regolabili - piletta scarico e troppo pieno inclusi.

## EN One bowl sinks

Without drainer - with bottom shelf - depth 700 mm - stainless steel structure - top and bowl in stainless steel AISI 304 - bottom shelf with omega reinforcement crossbar - h 100 mm backsplash - adjustable feet - drain and overflow drain included.

							
		cm	cm	Kg	Kg	N.	
 70	GD67BM1A	60 x 70 x 95(h)	70 x 80 x 60(h) cm	27	37	50 x 40 x 30	600 €
	GD77BM1A	70 x 70 x 95(h)	80 x 80 x 60(h) cm	28	38	50 x 60 x 30	610 €
	GD87BM1A	80 x 70 x 95(h)	90 x 80 x 60(h) cm	33	43	50 x 60 x 30	630 €

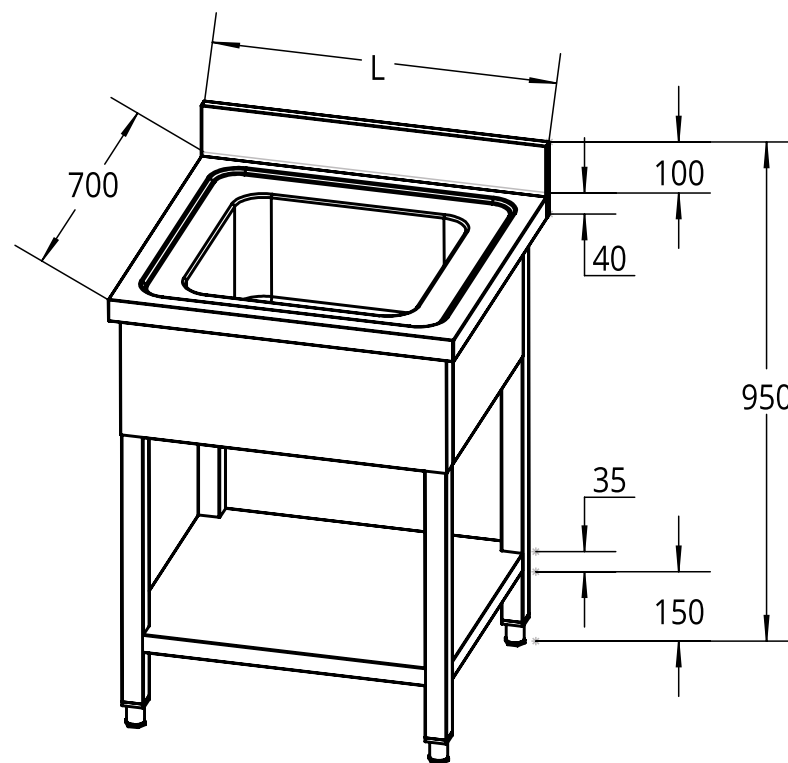

Lavelli aperti - 1 vasca  
One bowl sinks







  
MADE IN ITALY

## IT Lavelli aperti - 2 vasche

Senza sgocciolatoio con ripiano inferiore - profondità 700 mm - struttura in acciaio Inox - piano e vasca in acciaio inox AISI 304 - ripiano inferiore con rinforzo ad omega - alzatina h 100 mm - piedini regolabili - piletta scarico e troppo pieno inclusi.

## EN Two bowls sinks

Without drainer - with bottom shelf - depth 700 mm - stainless steel structure - top and bowl in stainless steel AISI 304 - bottom shelf with omega reinforcement crossbar - h 100 mm backsplash - adjustable feet - drain and overflow drain included.

							
	GD127BM2A	120 x 70 x 95(h)	130 x 80 x 60(h) cm	44 Kg	54 Kg	50 x 50 x 30	970 €
70							

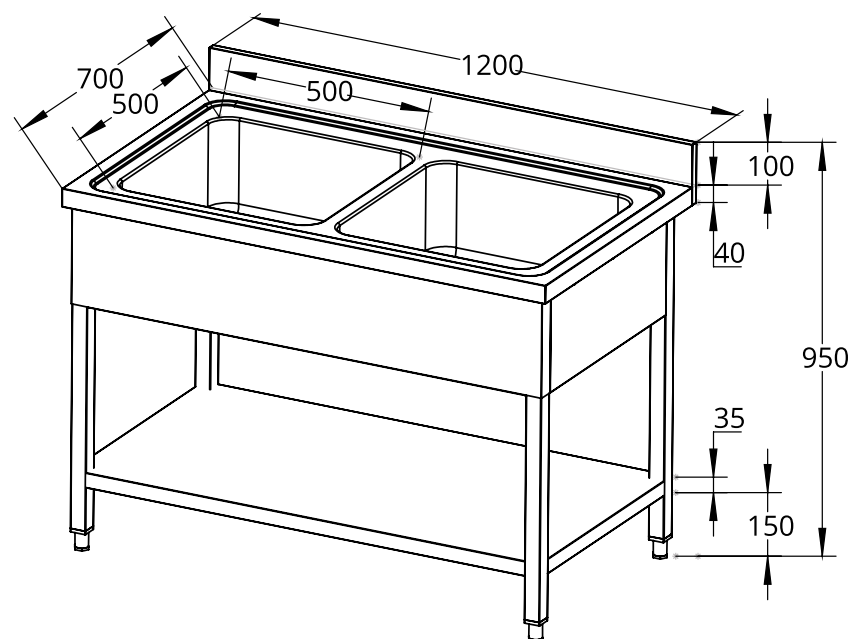

## IT Lavelli armadiati 1 vasca con sgocciolatoio

Porte scorrevoli - profondità 700 mm - struttura in acciaio Inox - piano e vasca in acciaio inox AISI 304 - ripiano inferiore con rinforzo ad omega - porte scorrevoli tamburate - alzatina h 100 mm - piedini regolabili - piletta scarico e troppo pieno inclusi.

## EN One bowl sinks with sliding doors and drainer

Sliding doors - depth 700 mm - stainless steel structure - top and bowl in stainless steel AISI 304 - bottom shelf with omega reinforcement crossbar - hollow core doors - h 100 mm backsplash - adjustable feet - drain and overflow drain included.

							
		cm	cm	Kg	Kg	N.	
 70	GDS107L1CS	100 x 70 x 95(h)	110 x 80 x 115(h)	58	68	1 SX/L - 50 x 40 x 30	930 €
	GDS107R1CS	100 x 70 x 95(h)	110 x 80 x 115(h)	58	68	1 DX/R - 50 x 40 x 30	930 €
	GDS127L1CS	120 x 70 x 95(h)	130 x 80 x 115(h)	60	70	1 SX/L - 50 x 50 x 30	970 €
	GDS127R1CS	120 x 70 x 95(h)	130 x 80 x 115(h)	60	70	1 DX/R - 50 x 50 x 30	970 €
	GDS147L1CS	140 x 70 x 95(h)	150 x 80 x 115(h)	68	78	1 SX/L - 60 x 50 x 30	1.040 €
	GDS147R1CS	140 x 70 x 95(h)	150 x 80 x 115(h)	68	78	1 DX/R - 60 x 50 x 30	1.040 €

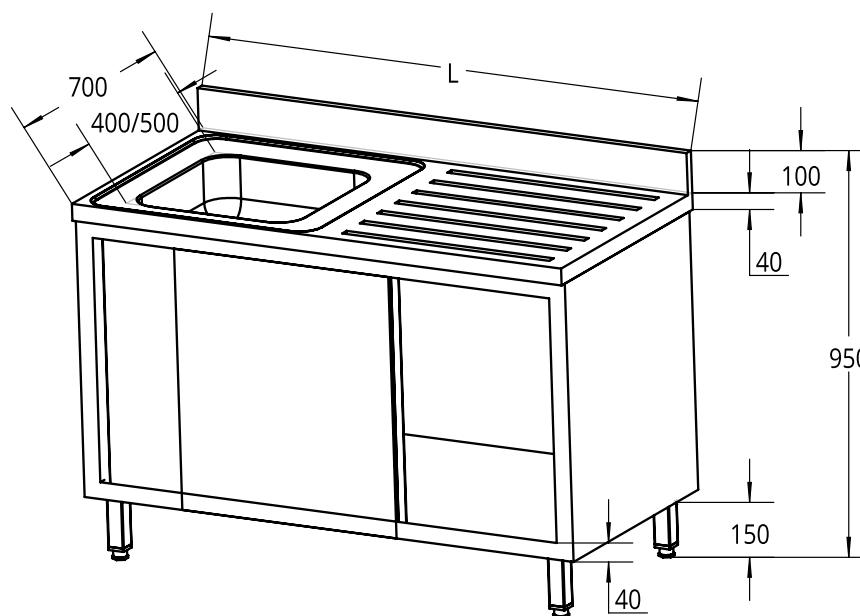

Lavelli armadiati - 1 vasca con sgocciolatoio  
One bowl sinks - with sliding doors and drainer







  
MADE IN ITALY

## IT Lavelli armadiati 2 vasche con sgocciolatoio

Porte scorrevoli - profondità 700 mm - struttura in acciaio Inox - piano e vasca in acciaio inox AISI 304 - ripiano inferiore con rinforzo ad omega - porte scorrevoli tamburate - alzatina h 100 mm - piedini regolabili - piletta scarico e troppo pieno inclusi.

## EN Two bowls sinks with sliding doors and drainer

Sliding doors - depth 700 mm - stainless steel structure - top and bowl in stainless steel AISI 304 - bottom shelf with omega reinforcement crossbar - hollow core doors - h 100 mm backsplash - adjustable feet - drain and overflow drain included.

							
		cm	cm	Kg	Kg	N.	
 70	GDS167L2CS	160 x 70 x 95(h)	170 x 80 x 115(h)	76	86	2 SX/L - 50 x 50 x 30	1.360 €
	GDS167R2CS	160 x 70 x 95(h)	170 x 80 x 115(h)	76	86	2 DX/R - 50 x 50 x 30	1.360 €
	GDS187L2CS	180 x 70 x 95(h)	190 x 80 x 115(h)	84	94	2 SX/L - 50 x 50 x 30	1.425 €
	GDS187R2CS	180 x 70 x 95(h)	190 x 80 x 115(h)	84	94	2 DX/R - 50 x 50 x 30	1.425 €

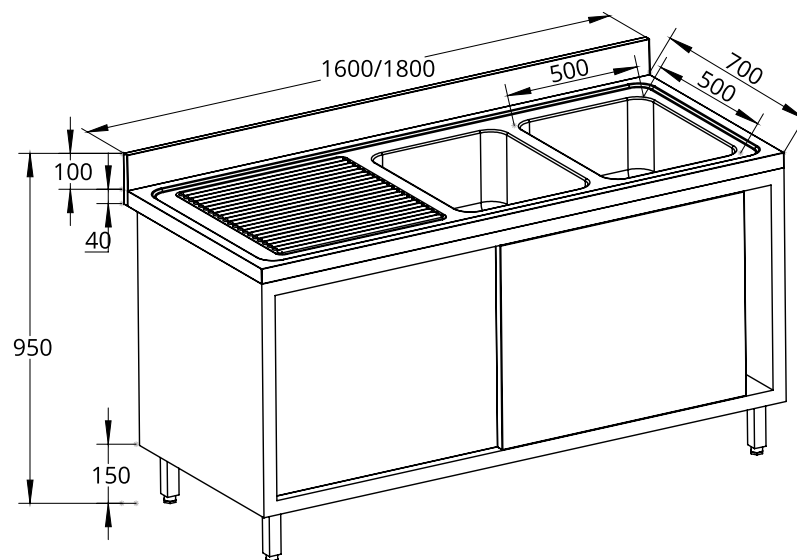







IT Lavello armadiato  
2 vasche centrali con sgocciolatoio

Porte scorrevoli - profondità 700 mm - struttura in acciaio Inox - piano e vasca in acciaio inox AISI 304 - ripiano inferiore con rinforzo ad omega - porte scorrevoli tamburate - alzatina h 100 mm - piedini regolabili - piletta scarico e troppo pieno inclusi.

EN Two central bowls sink  
with sliding doors and drainer

Sliding doors - depth 700 mm - stainless steel structure - top and bowl in stainless steel AISI 304 - bottom shelf with omega reinforcement crossbar - hollow core doors - h 100 mm backsplash - adjustable feet - drain and overflow drain included.

							
		cm	cm	Kg	Kg	N.	
70	GDS207M2CS	200 x 70 x 95(h)	210 x 80 x 115(h)	92	102	centrali/central 50 x 50 x 30	1.535 €

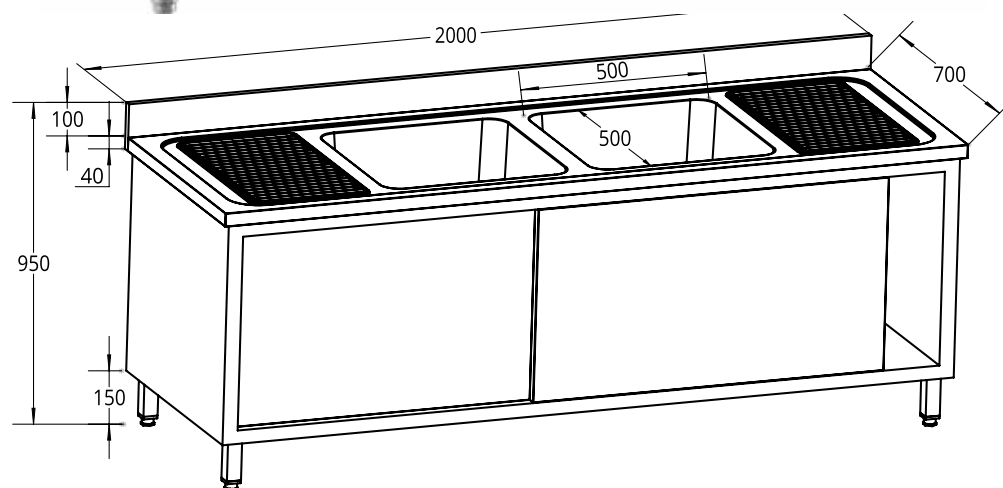

Lavello armadiato - 2 vasche centrali con sgocciolatoio  
Two central bowls sink - with drainer

  
MADE IN ITALY

# GDO120M

IT Gruppo doccia con miscelatore monoforo h 1200 mm. Con manopole multigiro.

EN Pre-rinse unit with single hole mixer h 1200 mm. Multiple turn knobs.

# GDO70MR





IT Gruppo doccia con miscelatore monoforo h 700 mm - con manopole multigiro e rubinetto.

EN Pre-rinse unit with single hole mixer h 700 mm - multiple turn knobs and service tap.

# GDO120MR

IT Gruppo doccia con miscelatore monoforo h 1200 mm - con manopole multigiro e rubinetto.

EN Pre-rinse unit with single hole mixer h 1200 mm - multiple turn knobs and service tap.

	 cm	 Kg	 Kg	
GDO120M	80 x 30 x 10(h)	4,1	4,9	295 €
GDO120MR	80 x 30 x 10(h)	4,7	5,5	375 €
GDO70MR	80 x 30 x 10(h)	4	4,8	370 €



GDO120M



GDO120MR

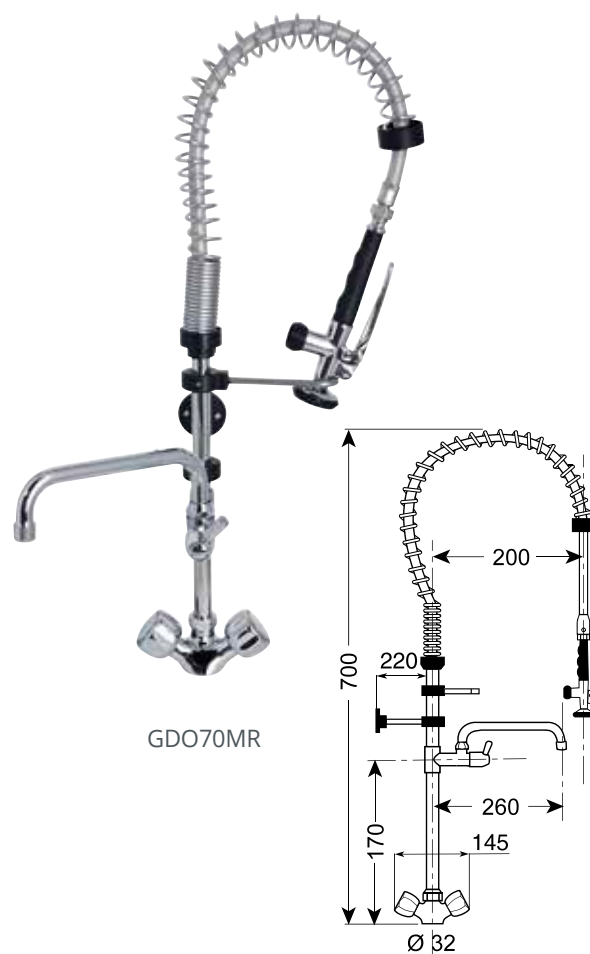

GDO70MR

# GDO120L

IT Gruppo doccia con miscelatore monoforo h 1200 mm - con leva clinica.

EN Pre-rinse unit with single hole mixer h 1200 mm - elbow lever.

# GDO120LR





IT Gruppo doccia con miscelatore monoforo h 1200 mm - con leva clinica e rubinetto.

EN Pre-rinse unit with single hole mixer h 1200 mm - elbow lever and service tap.

# GDO70LR

IT Gruppo doccia con miscelatore monoforo h 700 mm - con leva clinica e rubinetto.

EN Pre-rinse unit with single hole mixer h 700 mm - elbow lever and service tap.

	 cm	 Kg	 Kg	
GDO120L	80 x 30 x 10(h)	4,3	5,1	335 €
GDO120LR	80 x 30 x 10(h)	4,8	5,6	405 €
GDO70LR	80 x 30 x 10(h)	4,1	4,9	400 €

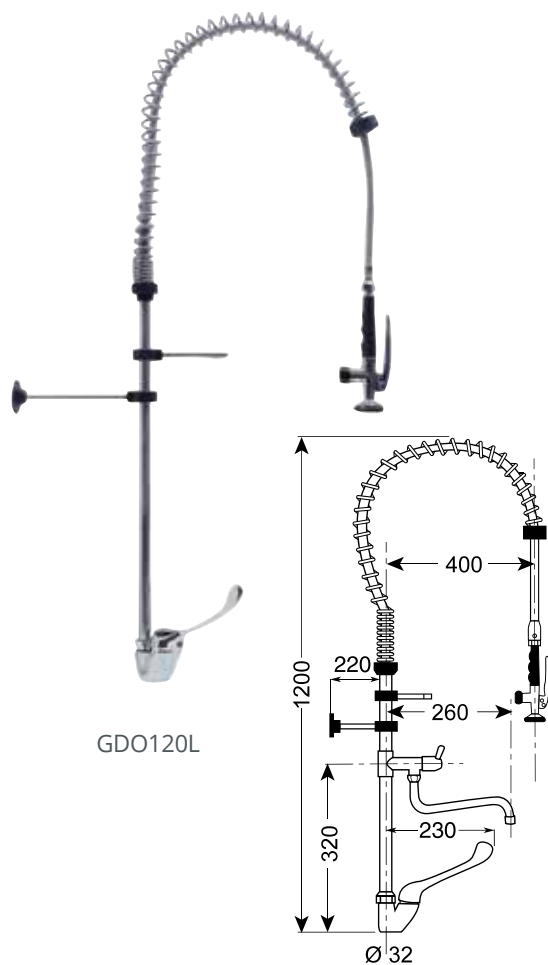

GDO120L

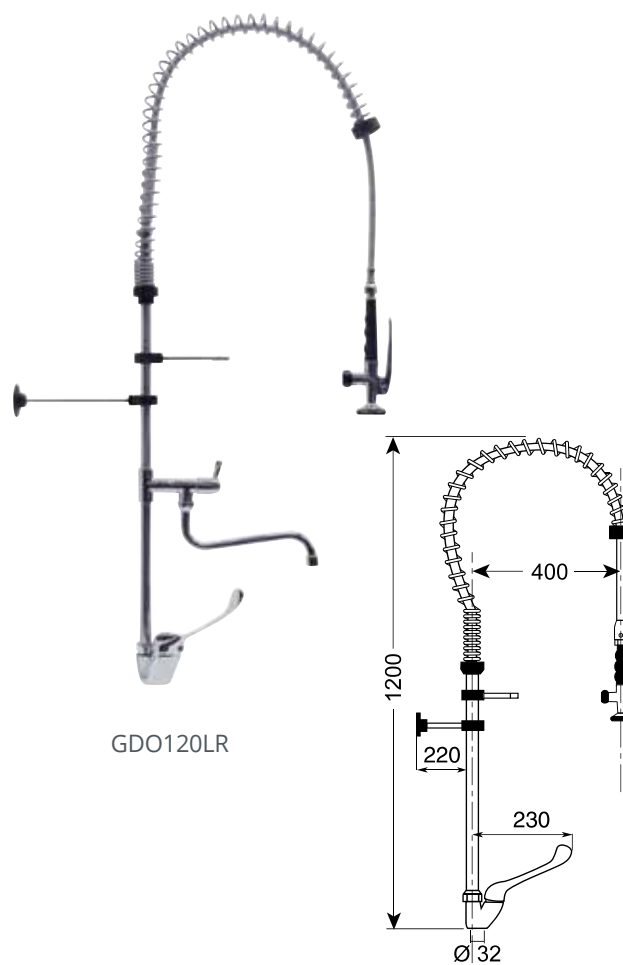

GDO120LR

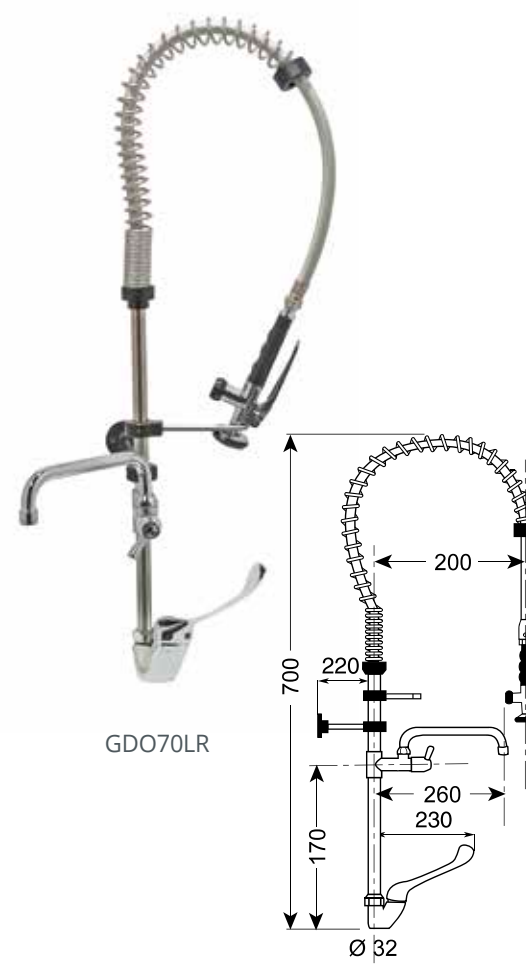

GDO70LR

  
MADE IN ITALY

# MIS22LC





IT Miscelatore monoforo con leva clinica - L 220 mm - uscita tubo bassa.

EN Single hole mixer with elbow lever L 220 mm - Lower spout.

# MIS22LP

IT Miscelatore monoforo con leva clinica in plastica nera - L 220 mm - uscita tubo bassa.

EN Single hole mixer with black lever L 220 mm - Lower spout.

	 cm	 Kg	 Kg	
MIS22LC	37 x 14 x 7(h)	1	1,1	100 €
MIS22LP	37 x 14 x 7(h)	0,95	1,05	95 €



# MISDOES





IT Miscelatore monoforo - leva e doccetta estraibile.

EN Single hole mixer - pull out hose, elbow lever.

# RUB30M

IT Rubinetto monoforo con manopole multigiro L 300 mm.

EN Single hole mixer with multiple turn knobs, L 300 mm.

	 cm	 Kg	 Kg	
MISDOES	34 x 18 x 7(h)	1,6	1,7	150 €
RUB30M	42 x 17 x 9(h)	1	1,1	85 €



MISDOES

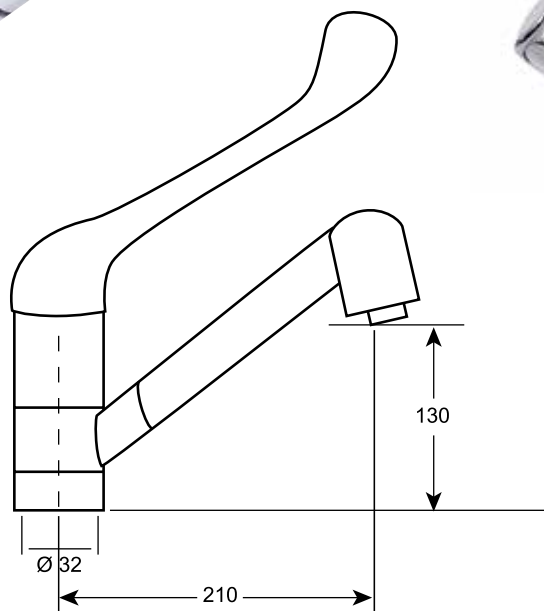

RUB30M

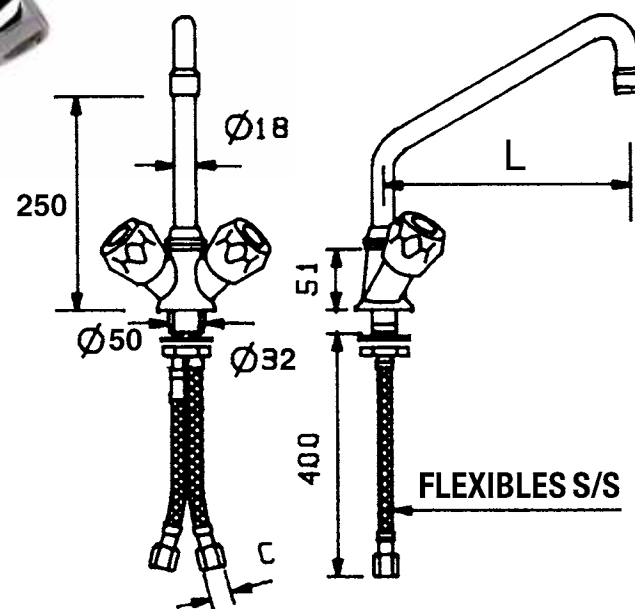





  
MADE IN ITALY

# PEDA1MON

IT Rubinetto a pedale a terra monoacqua. Blocco unico ad un pedale (1 entrata - 1 uscita).

EN Foot operated tap cold water, floor fixing, single lever (1 inlet - 1 outlet).

	 cm	 Kg	 Kg	
PEDA1MON	29 x 10 x 10(h)	1	1,1	120 €
PEDA1MIS	30 x 13 x 11(h)	1,5	1,6	140 €

# PEDA1MIS

IT Rubinetto a pedale a terra con miscelatore - fissaggio a blocco unico ad un pedale (2 entrate - acqua fredda/calda - 1 uscita acqua miscelata).

EN Mixer foot operated tap, floor fixing, single lever (2 water inlet - cold/hot - 1 mixed water outlet).



PEDA1MON

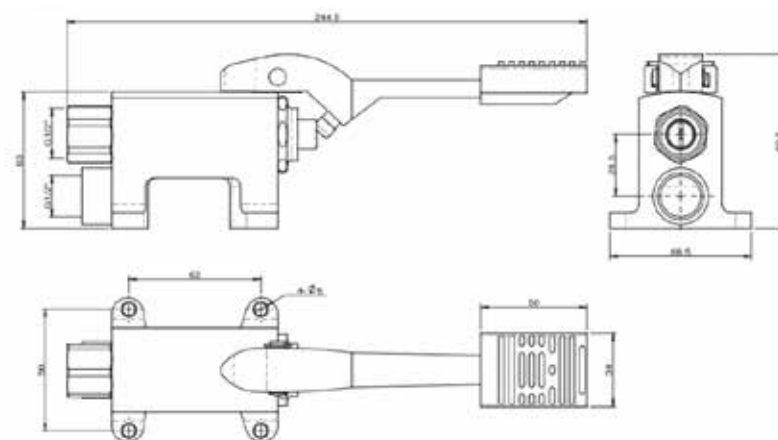



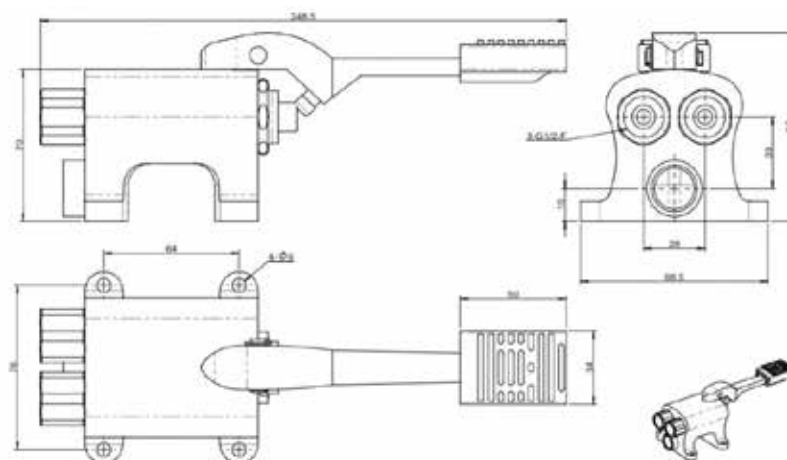

PEDA1MIS



# PEDA2

IT Rubinetto a doppio pedale - fissaggio a terra - blocco unico.

EN Mixer foot operated tap, floor fixing, two levers.

	 cm	 Kg	 Kg	
PEDA2	29 x 15 x 10(h)	1,7	1,8	190 €
BOERO20	busta pluriball plastic bag	0,23	0,23	26 €
BOERO30	busta pluriball plastic bag	0,28	0,28	30 €

# BOERO20 - BOERO30

IT Bocca di erogazione orientabile completa di base ø 18 mm.

EN Swivelling spout with base ø 18 mm.



PEDA2

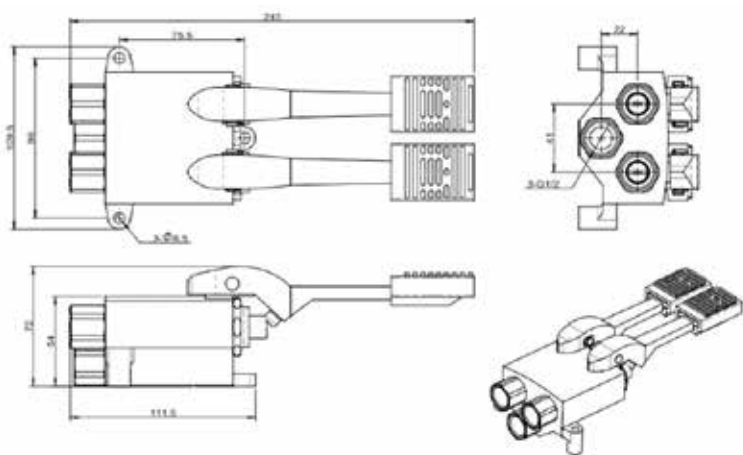

BOERO20  
BOERO30

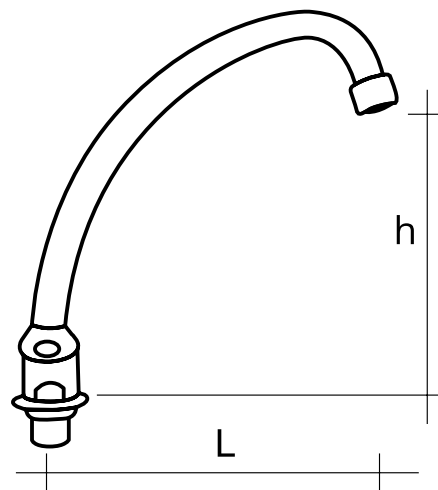

1/2" GAS

BOERO20 = L 200 mm - h = 180 mm

BOERO30 = L 300 mm - h = 225 mm



MADE IN ITALY











**Fimar S.p.a.**

Via Del Tesoro, 301  
47826 Villa Verucchio (Rimini) Italy  
t. +39 0541 670736  
info@fimargroup.it

**FIMARGROUP.IT  
FIMARSPA.IT  
EASYLINEBYFIMAR.IT  
FORCAR.IT  
FORCOLD.IT**