



Creative Cooking. Delicious Dining.



# AMEFA FOR PROFESSIONALS

# STRONG BRANDS. STRONG PRODUCTS.



Founded in 1931, Amefa Group has been built on the catering and food service industry and we have become one of the key players in this sector. Amefa products are sold in more than 85 countries across the globe and are the first choice for millions of homes and restaurants every day. With our brands Amefa, Richardson Sheffield, Couzon, Cuisinox, Kuppels, Paul Wirths, Lou Laguiole, Sabatier Trompette and Medard de Noblat, our products can be found on tables and kitchens all over the world.





# INDEX

## ABOUT AMEFA

Brand overview	2-3
About Ameфа	6-7
Ameфа history	8-9
References national / international	10-11
Quality and craftsmanship	13
Cutlery maintenance	14
Silver plated	15
PVD colored cutlery	16
Stonewash	17
Velvet	17

## CUTLERY AMEFA PREMIERE

1012 Regency	20
0120 Elizabeth	22
1170 Metropole	23
1170 Metropole Copper	24
1170 Metropole Champagne	25
1170 Metropole Black	26
1170 Metropole Gold	27
1170 Metropole Velvet	28-29
1860 Oxford	30
1860 Oxford Black	31
1860 Oxford Gold	32
1860 Oxford Copper	33
1860 Oxford Champagne	34
5210 Augsburgер Faden	36
5280 Duke	37
8010 Jewel	38
8020 Cube	39
8050 Drift	40
8051 Sierra	41
8060 Tokyo	42
8310 Opus	43
8330 Venus	44
8330 Venus Black	46
8330 Venus Gold	47
8330 Venus Velvet	48
8340 Orphee	50
8090 Newton	51
9065 Aurora	52
9090 Tendence	53

## CUTLERY AMEFA 18-10

1026 Colorado	56
1120 Cuba	57
1316 Martin	58
1923 Moderno	59
1810 Florence	60
1824 Atlantic	61
1924 Ventura	62
1924 Ventura Black	63
1924 Ventura Gold	64
1924 Ventura Copper	65

1924 Ventura Champagne	66
7204 Elegance	68
8410 Palmon	70
8420 Sonate	71
8430 Haydn	72
8440 Baguette	73
8440 Baguette Stonewash	74

## CUTLERY AMEFA 18/0

0900 Filet	79
1114 Soprano	80
1114 Soprano Copper	81
1114 Soprano Black/Gold	82
1114 Soprano Black	83
1410 Austin	84
1410 Austin Stonewash	85
1410 Austin Black	86
1410 Austin Gold	87
1410 Austin Copper	88
1410 Austin Champagne	89
1570 Bologna	90
1933 Bliss	91
2515 Pixel Blue Lagoon	92
2515 Pixel Cherry	93
2515 Pixel Mango	94
2515 Pixel Lemon	95
9036 Havane Jungle	97
2390 Scandinave	98
3319 Felicity	99
3319 Felicity Black	100
3319 Felicity Champagne	101
3319 Felicity Rose Champagne	102
2374 Amsterdam	104

## SPECIALTIES

3010 Integrale	107
3000 Select	108
3001 Select	109

## SUSTAINABLE

0295 Slim	112
0259 Leaves	113
2301 Phoenix	114-115

## BUFFET

1319 Buffet	118-119
1319 Buffet Velvet	120
1319 Buffet Black	121
1319 Buffet Copper	122
1319 Buffet Stonewash	124
1319 Buffet Gold	125

## SPECIAL SERVING

0905 Juntos	128-129
0905 Juntos Gold	130
0905 Juntos Black	131
Specials	132-133
0024 Bear	134
4310 Teddy Bear	135

## STEAK, SALT&PEPPER MILLS

2520 Royal Steak	138
2465 Bongo Hammered	139
2550 Achile	140
4917 Hercule	141
4918 Fusion	142
7038 Chuletero	143
7000 Pizza	144
7000 Pizza Wood	145
7025 Steak	146
7060 Tender Lion	147
6765 Salt&Pepper Modern	148-149
6765 Salt&Pepper Classic	150-151

## CASH & CARRY AMEFA PREMIERE

1170 Metropole	154
1170 Metropole Black	154
1170 Metropole Gold	154
1170 Metropole Champagne	154
1170 Metropole Velvet	154
8050 Drift	154
1860 Oxford	155
1860 Oxford Black	155
1860 Oxford Gold	155
1860 Oxford Champagne	155
2520 Royal Steak	155

## CASH & CARRY AMEFA

0900 Filet	156-157
1410 Austin	156-157
1410 Austin Stonewash	156-157
1410 Austin Gold	156-157
1410 Austin Black	156-157
3319 Felicity	156-157
1810 Florence	156-157
1933 Bliss	156-157
2374 Amsterdam	156-157
7038 Chuletero	156-157
7204 Elegance	156-157
8440 Baguette	156-157
1114 Soprano	156-157
1114 Soprano Copper	156-157
1114 Soprano Velvet	156-157
1114 Soprano Black/Gold	156-157
2301 Phoenix	156-157

## TUBES

0265 Eco	158
2374 Amsterdam	159

## KITCHEN KNIVES - RICHARDSON SHEFFIELD

R400 Kitchen Essentials	160-161
-------------------------	---------

## KITCHEN KNIVES - SABATIER TROMPETTE

8657 Vulcano	166-167
8701 Asean	168-169
8780 Origin	170-171
8888 Pro Tech	172-173
9130 Magnetic racks	174-175





# CREATIVE COOKING. DELICIOUS DINING.

At Amefa we know all about cutlery. After all, we've been setting tables all over the world since 1931, the year that Amefa was founded by the young, entrepreneurial Eugen Hollaender as the Apeldoorn Knife Factory.

We are proud to say that we are one of Europe's leading suppliers of cutlery and related products and that our company is still based in Apeldoorn.

Fourchette or gaffe? Cuchillo or coltello? There are lots of languages spoken at our table. Amefa cutlery can be found on tables all over the world and is sold in more than 85 countries.



### Establishing Amefa

On 19 September 1931 Eugen Hollaender, at the age of 25, established the 'Apeldoornsche Messenfabriek N.V. Haagse Import Maatschappij Olanda'. Together with a few employees Eugen started producing razor blades. At that time many men wanted a smooth shave in order to impress the ladies. Demand for razor blades grew considerably during the early years of the war.

In the following years the production of razor blades gradually came to an end. After Eugen Hollaender visited Japan for the first time to buy flatware, the company's importing activities really took off. The imported products were sized and finished crudely, so final processing still took place in Apeldoorn.

### International sales network

In the nineties Amefa expanded considerably. Subsidiaries were opened in the UK, Poland, Hong Kong, France, Spain and Italy. The company grew into one of the biggest players in the international cutlery market. In 1992 Amefa obtained the rights to the Monogram flatware brand. This brand has become internationally renowned for modern, trendy and timeless designs at an attractive price point.



### In-house silver plating

Silver plating is the difficult process of bonding a silver layer to stainless steel.

In 1964, Amefa developed a new technique together with specialists from Solingen in Germany and started its own silver-plating department.

To improve the sales network, Amefa Solingen was established in Germany in 1966. The first of many to follow! And in order to coordinate imports, Erik Hollaender settled in Japan and soon established Amefa (Far-East) Ltd. in Niigata-Ken in 1968.



1931



1941



1948



1956



1966

# AMEFA HISTORY



## Expanding brand portfolio

Amefa Premiere, a beautiful and inspiring new flatware brand, was introduced into the market in 2002 with the aim of gaining ground in the premium market sectors. The mid and low end sectors had already been won over by the Amefa and Monogram brands. In 2004 Eugen Hollaender's youngest son Fred Hollaender became responsible for the Amefa Group. At the end of 2005, Amefa took over the French company Couzon, thereby gaining ground in the French and international markets. In 2005 Amefa also started a purchasing office in Tianjin, China. At the end of 2007 Amefa took over the renowned kitchen knife manufacturer Richardson. The Richardson Sheffield brand added international credibility to the kitchen knife portfolio of the company.



## First steps in porcelain...

In 2010 Amefa took over Medard de Noblat, a French manufacturer of high-quality tableware from Limoges, an addition which fits in with the new Amefa set table strategy. From 2014 Amefa took over the well-known international brands of Cuisinox, Paul Wurths, Lou Laguiole and Kuppels. With all these products Amefa is able to operate in international set table markets. From 2013 onwards Peter Hollaender, grandson of the founder and therefore the 3rd generation family, became CEO.

## Amefa: an innovative company

Today Amefa is a company that constantly innovates. In 2015 Amefa introduced a new set Integral. Integral has been specifically developed for people with limited gripping ability and wrist movement. Its aesthetic appearance and proven functionality allow users to eat independently and makes the everyday pleasures of good food even more enjoyable. Integral won an international RedDot Award in 2015.



1988



2000



2015

today

# REFERENCES NATIONAL/ INTERNATIONAL



Hotel Van der Valk - The Netherlands



Hotel Pacai - Lithuania



Hotel Nana Beach - Greece



Hilton Royal Senses Resort - Greece



Ahoy Rotterdam - The Netherlands



Mandarin Oriental Downtown Dubai - U.A.E.



Fred Olsen Cruise Lines - United Kingdom



Rixos Hotel Palm Jumeirah Dubai - U.A.E.



Etihad Stadium (Manchester City) - United Kingdom



Emirates Palace Mandarin Oriental Abu Dhabi - U.A.E.



Landal Park - The Netherlands



Sofitel Hotel Convention Centre Riyadh - K.S.A.



Waldorf Astoria Lusail Doha - Qatar



One&Only Royal Mirage Resort Dubai - U.A.E.



# QUALITY AND CRAFTSMANSHIP

Cutlery is widely available in all shapes and sizes. What makes Amefa stand out is our passion for quality and craftsmanship. To ensure durability and lasting performance, we apply high quality standards to all our products. Based on our extensive expertise, we make sure that price and quality always go hand in hand.

Amefa understands the significance of social responsibility. For over a decade, we have been a proud member of the Business Social Compliance Initiative (Amfori BSCI). All our products are made in BSCI certified factories. To drive environmental improvements in our business activities we also became a member of Business Environmental Performance Initiative (Amfori BEPI).



BSCI



BEPI



# CUTLERY MAINTENANCE

## All Amefa products are subjected to rigorous quality control.

Cutlery is produced in either 18/0 chrome steel or 18-10 chrome-nickel steel. These types of steel are stain resistant. Modern dishwashing systems and today's aggressive detergents will not be harmful to your cutlery as long as you follow these guidelines.

### Stains on cutlery can be caused by:

- Insufficient cleaning or drying
- Too high a dosage of detergent
- Not rinsing the cutlery after usage so acids and salts from food products can stain or damage the cutlery.
- Contact between various types of steel like chrome and chrome nickel steel or chrome nickel steel and silver(plated) material. (contact corrosion)

## To prevent stains we advise you to follow these instructions:

- Rinse the cutlery directly after usage
- Dry cutlery by hand with a dry cloth if still moist after cleaning in the dishwasher.
- Please follow the dosage of detergents as per the instructions of the manufacturers. Very dirty dishes do not require a higher dosage of detergent.
- Follow the maintenance instructions of your dishwasher meticulously.
- To prevent contact corrosion (caused by different types of steel which come into contact with each other) we advise you to put the knives in a different basket than the forks and/or spoons.
- Place the blade of the knife upwards and the prongs of the forks as well. This causes the water to rinse off easily and to guarantee proper cleaning of the various items.
- Remove the cutlery from the dishwasher as soon as the cleaning program is finished.

# SILVER PLATED

## **Silver plated cutlery**

Silver plated cutlery is the epitome of table culture. The silk appearance of the material is unique and adapts to use on both classic and contemporary patterns. Amefa has a range of patterns suitable for silver plating, which comply with the most stringent quality demands of the industry. For the modern silver-plating process, Amefa always uses the 'electro plating' of silver onto the chrome nickel steel, which complies with the European Standards EN ISO 8442-2. The material is as important as the finishing. We therefore only use the highest quality 18-10 chrome nickel steel.



# PVD COLORED CUTLERY

This season's most versatile PVD colours bring a touch of warmth and understated glamour to the table. Expertly cut from the finest materials and polished to a sublime finish. PVD (Physical Vapor Deposition) means several layers of titanium coating were added to give the cutlery a vibrant colour that makes a true statement on any table. Whatever your choice, mirror or matt, daring black or glamorous copper, our coloured cutlery collection will be the talk of the table.



# STONEWASH



For those who like to bring something special, our stone-washed cutlery brings character and charm to your table setting. Tumbler stones create the 'aged' look that has taken its place at the modern day table. At first glance every spoon, fork and knife looks the same, but when you look closer, you will see not one item is exactly alike.



# VELVET

The newest addition to the Amefa portfolio is the velvet finish. Achieved via micro sandblasting this unique finish mimics the soft feeling of a real velvet fabric. The visually captivating effect not only gives a luxurious look and feel, it's also fingerprint proof and dishwasher safe.





# AMEFA PREMIERE COLLECTION

When it comes to pulling out all the stops, with our Premiere cutlery we not only strive to meet, but exceed our customers' expectations. Effortlessly chic designs crafted in exceptional quality 18-10 stainless steel. Each piece is finished to our exacting quality standards and will give you years of exemplary service.



# 1012 REGENCY

CUTLERY  
AMEFA PREMIERE



**THICKNESS:**  
3,2 mm

**MATERIAL:**  
18-10

**FINISH:**  
mirror/hoogglans

	DESCRIPTION	CODE	LENGTH MM	BARCODE 871115
	Table Knife Hollow Handle / Tafelmes Holheft	300	249	5063858
	Steak Knife / Steakmes	315	240	5069294
	Table Fork / Tafelvork	320	208	5031963
	Table Spoon / Tafellepel	325	203	5031956
	Dessert Knife Hollow Handle / Dessertmes Holheft	330	211	5063896
	Dessert Knife / Dessertmes	335	210	5051107
	Dessert Fork / Dessertvork	340	183	5063889
	Dessert Spoon / Dessertlepel	345	179	5051114
	Fruit/Cocktail Knife / Fruit/Cocktail Mes	360	171	5096641
	Medium Teaspoon / Koffielepel	375	133	5031970
	Mocca Spoon / Theelepel	380	112	5051138
	Cake Fork / Gebakvork	390	139	5031987
	Fish Knife / Vismes	410	209	5063865





# 0120

# ELIZABETH













CUTLERY  
AMEFA PREMIERE



**THICKNESS:**  
3,0 mm

**MATERIAL:**  
18-10

**FINISH:**  
mirror/hoogglans

	DESCRIPTION	CODE	LENGTH MM	BARCODE 871115
	Table Knife / tafelmes	305	245	5137252
	Table Fork / tafelvork	320	209	5140054
	Table Spoon / tafellepel	325	208	5140030
	Dessert Knife /dessertmes	335	214	5137856
	Dessert Fork / dessertvork	340	188	5140894
	Dessert Spoon / dessertlepel	345	186	5140870
	Round Soup Spoon / dessertlepel ronde bak	350	175	5140863
	Cocktail Fork / cocktailvork	365	145	5144861
	Cocktail Spoon / cocktaillepel	370	146	5144854
	Medium Teaspoon / koffielepel	375	137	5128861
	Mocca Spoon / theelepel	380	123	5129080
	Cake Fork / gebakvork	390	135	5145141























# 1170 METROPOLE



**THICKNESS:**  
4,0 mm

**MATERIAL:**  
18-10

**FINISH:**  
mirror/hoogglans

	DESCRIPTION	CODE	LENGTH MM	BARCODE 871115
	Table Knife / tafelmes	305	225	5136231
	Steak Knife / steakmes	315	225	5136200
	Table Fork / tafelvork	320	207	5139577
	Table Spoon / tafellepel	325	207	5139645
	Dessert Knife / dessertmes	335	205	5136866
	Dessert Fork / dessertvork	340	190	5139911
	Dessert Spoon / dessertlepel	345	190	5139935
	Round Soup Spoon / dessertlepel ronde bak	350	190	5139867
	Fruit knife / fruit-/cocktailmesje	360	170	5138303
	Medium Teaspoon / koffielepel	375	138	5143079
	Mocca Spoon / theelepel	380	114	5143468
	Cake Fork / gebakvork	390	145	5142782
	Iced Teaspoon / sorbetlepel	400	180	5140511
	Fish Knife / vismes	410	205	5139539
	Fish Fork / visvork	415	197	5139546
	Gravy Ladle / sauslepel	430	192	5132103
	Vegetable Spoon / groentelepel	435	225	5135098
	Salad Serving Fork / sladienvork	445	227	5135074
	Salad Serving Spoon / sladienlepel	450	227	5135081
	Cake Server / gebakschep	455	256	5135104
	Butter spreader / botermes	470	160	5136224



# 1170

## METROPOLE COPPER











CUTLERY  
AMEFA PREMIERE



**THICKNESS:**  
4,0 mm

**MATERIAL:**  
18-10

**FINISH:**  
mirror/hoogglans PVD

DESCRIPTION	CODE	LENGTH MM	BARCODE 871115
 Table Knife / tafelmes	305	225	5430902
 Table Fork / tafelvork	320	207	5430933
 Table Spoon / tafellepel	325	207	5430964
 Dessert Knife / dessertmes	335	205	5430995
 Dessert Fork / dessertvork	340	190	5431022
 Dessert Spoon / dessertlepel	345	190	5431053
 Round Soup Spoon / Dessertlepel Ronde Bak	350	187	5468028
 Medium Teaspoon / koffielepel	375	138	5431084
 Mocca Spoon / theelepel	380	114	5431114
 Cake Fork / gebakvork	390	145	5443407
 Iced Teaspoon / sorbetlepel	400	180	5449164



# 1170









# METROPOLE CHAMPAGNE



**THICKNESS:**  
4,0 mm

**MATERIAL:**  
18-10

**FINISH:**  
mirror/hoogglans PVD

	DESCRIPTION	CODE	LENGTH MM	BARCODE 871115
	Table Knife / tafelmess	305	225	5445166
	Table Fork / tafelvork	320	207	5445227
	Table Spoon / tafellepel	325	207	5445258
	Dessert Knife / dessertmess	335	205	5445289
	Dessert Fork / dessertvork	340	190	5445319
	Dessert Spoon / dessertlepel	345	190	5445340
	Round Soup Spoon / Dessertlepel Ronde Bak	350	187	5475651
	Medium Teaspoon / koffielepel	375	138	5445371
	Mocca Spoon / theelepel	380	114	5445401
	Cake Fork / gebakvork	390	145	5445432
	Iced Teaspoon / sorbetlepel	400	180	5449225



# 1170 METROPOLE BLACK











CUTLERY  
AMEFA PREMIERE



**THICKNESS:**  
4,0 mm

**MATERIAL:**  
18-10

**FINISH:**  
mirror/hoogglans PVD

	DESCRIPTION	CODE	LENGTH MM	BARCODE 871115
	Table Knife / tafelmes	305	225	5431145
	Table Fork / tafelvork	320	207	5431176
	Table Spoon / tafellepel	325	207	5431206
	Dessert Knife / dessertmes	335	205	5431237
	Dessert Fork / dessertvork	340	190	5431268
	Dessert Spoon / dessertlepel	345	190	5431299
	Round Soup Spoon / Dessertlepel Ronde Bak	350	187	5464518
	Medium Teaspoon / koffielepel	375	138	5431329
	Mocca Spoon / theelepel	380	114	5431350
	Cake Fork / gebakvork	390	145	5443469
	Iced Teaspoon / sorbetlepel	400	180	5446385















# 1170 METROPOLE GOLD



**THICKNESS:**  
4,0 mm

**MATERIAL:**  
18-10

**FINISH:**  
mirror/hoogglans PVD

	DESCRIPTION	CODE	LENGTH MM	BARCODE 871115
	Table Knife / tafelmes	305	225	5431381
	Table Fork / tafelvork	320	207	5431411
	Table Spoon / tafellepel	325	207	5431442
	Dessert Knife / dessertmes	335	205	5431473
	Dessert Fork / dessertvork	340	190	5431503
	Dessert Spoon / dessertlepel	345	190	5431534
	Round Soup Spoon / Dessertlepel Ronde Bak	350	187	5467991
	Fruit knife / fruit-/cocktailmesje	360	170	5138303
	Medium Teaspoon / koffielepel	375	138	5431565
	Mocca Spoon / theelepel	380	114	5431596
	Cake Fork / gebakvork	390	145	5443520
	Iced Teaspoon / sorbetlepel	400	180	5449195



# 1170



## METROPOLE VELVET

CUTLERY  
AMEFA PREMIERE

**THICKNESS:**  
4,0 mm

**MATERIAL:**  
18-10

**FINISH:**  
velvet

	DESCRIPTION	CODE	LENGTH MM	BARCODE 871115
	Table Knife / tafelmtes	305	225	5499183
	Table Fork / tafelvork	320	207	5499213
	Table Spoon / tafellepel	325	207	5499244
	Dessert Knife / dessertmes	335	205	5499275
	Dessert Fork / dessertvork	340	190	5499305
	Dessert Spoon / dessertlepel	345	190	5499336
	Round Soup Spoon / dessertlepel ronde bak	350	190	5500582
	Medium Teaspoon / koffielepel	375	138	5499367
	Mocca Spoon / theelepel	380	114	5499398
	Cake Fork / gebakvork	390	145	5499428
	Iced Teaspoon / sorbetlepel	400	180	5499459



## Velvet finish

**Metropole** is a model with long, slender lines and a sloping handle at the bottom. The design is based on contemporary city architecture and has a modern appearance. It is made of 18-10 stainless steel with a **unique velvet finish** that mimics the soft feeling of a real velvet fabric. This visually captivating effect gives a **luxurious** look and feel.

## Unique selling points



## Overview finishes Metropole



Mirror



Copper Mirror PVD



Gold Mirror PVD



Velvet



Champagne Mirror PVD



Black Mirror PVD

# 1860 OXFORD













CUTLERY  
AMEFA PREMIERE



**THICKNESS:**  
3,5 mm

**MATERIAL:**  
18-10

**FINISH:**  
mirror/hoogglans

	DESCRIPTION	CODE	LENGTH MM	BARCODE 871115
	Table Knife / tafelmes	305	226	5136880
	Steak Knife / steakmes	315	226	5136910
	Table Fork / tafelvork	320	201	5140603
	Table Spoon / tafellepel	325	203	5140634
	Dessert Knife / dessertmes	335	212	5137405
	Dessert Fork / dessertvork	340	186	5141020
	Dessert Spoon / dessertlepel	345	189	5141037
	Round Soup Spoon / dessertlepel ronde bak	350	176	5141075
	Medium Teaspoon / koffielepel	375	133	5144311
	Mocca Spoon / theelepel	380	109	5144731
	Cake Fork / gebakvork	390	156	5143840
	Iced Teaspoon / sorbetlepel	400	221	5141648



# 1860 OXFORD BLACK

**THICKNESS:**  
3,5 mm

**MATERIAL:**  
18-10

**FINISH:**  
mirror/hoogglans PVD

	DESCRIPTION	CODE	LENGTH MM	BARCODE 871115
	Table Knife / tafelmes	305	226	5431862
	Table Fork / tafelvork	320	201	5431893
	Table Spoon / tafellepel	325	203	5431923
	Dessert Knife / dessertmes	335	212	5431954
	Dessert Fork / dessertvork	340	186	5431985
	Dessert Spoon / dessertlepel	345	189	5432012
	Round Soup Spoon / dessertlepel Ronde Bak	350	176	5495321
	Medium Teaspoon / koffielepel	375	133	5432043
	Mocca Spoon / theelepel	380	109	5432074
	Cake Fork / gebakvork	390	156	5443490
	Iced Teaspoon / sorbetlepel	400	221	5449553



# 1860 OXFORD GOLD

CUTLERY  
AMEFA PREMIERE



**THICKNESS:**  
3,5 mm

**MATERIAL:**  
18-10

**FINISH:**  
mirror/hoogglans PVD

	DESCRIPTION	CODE	LENGTH MM	BARCODE 871115
	Table Knife / tafelmtes	305	226	5432104
	Table Fork / tafelvork	320	201	5432135
	Table Spoon / tafellepel	325	203	5432166
	Dessert Knife / dessertmes	335	212	5432197
	Dessert Fork / dessertvork	340	186	5432227
	Dessert Spoon / dessertlepel	345	189	5432258
	Round Soup Spoon / dessertlepel Ronde Bak	350	176	5495352
	Medium Teaspoon / koffielepel	375	133	5432289
	Mocca Spoon / theelepel	380	109	5432319
	Cake Fork / gebakvork	390	156	5443551
	Iced Teaspoon / sorbetlepel	400	221	5449522



# 1860 OXFORD COPPER



**THICKNESS:**  
3,5 mm

**MATERIAL:**  
18-10

**FINISH:**  
mirror/hoogglans PVD

	DESCRIPTION	CODE	LENGTH MM	BARCODE 871115
	Table Knife / tafelmes	305	226	5431626
	Table Fork / tafelvork	320	201	5431657
	Table Spoon / tafellepel	325	203	5431688
	Dessert Knife / dessertmes	335	212	5431718
	Dessert Fork / dessertvork	340	186	5431749
	Dessert Spoon / dessertlepel	345	189	5431770
	Round Soup Spoon / dessertlepel Ronde Bak	350	176	5500612
	Medium Teaspoon / koffielepel	375	133	5431800
	Mocca Spoon / theelepel	380	109	5431831
	Cake Fork / gebakvork	390	156	5443438
	Iced Teaspoon / sorbetlepel	400	221	5449492



# 1860

# OXFORD CHAMPAGNE

CUTLERY  
AMEFA PREMIERE



**THICKNESS:**  
3,5 mm

**MATERIAL:**  
18-10

**FINISH:**  
mirror/hoogglans PVD

	DESCRIPTION	CODE	LENGTH MM	BARCODE 871115
	Table Knife / tafelmes	305	226	5445463
	Table Fork / tafelvork	320	201	5445494
	Table Spoon / tafellepel	325	203	5445524
	Dessert Knife / dessertmes	335	212	5445555
	Dessert Fork / dessertvork	340	186	5445586
	Dessert Spoon / dessertlepel	345	189	5445616
	Round Soup Spoon / dessertlepel Ronde Bak	350	176	5500643
	Medium Teaspoon / koffielepel	375	133	5445647
	Mocca Spoon / theelepel	380	109	5445678
	Cake Fork / gebakvork	390	156	5445708
	Iced Teaspoon / sorbetlepel	400	221	5449584





# 5210

# AUGSBURGER FADEN





CUTLERY  
AMEFA PREMIERE



**THICKNESS:**  
3,5 mm

**MATERIAL:**  
18-10

**FINISH:**  
mirror/hoogglans PVD

	DESCRIPTION	CODE	LENGTH MM	BARCODE 871115
	Table Knife Hollow Handle / Tafelmes Holheft	300	240	5061090
	Table Knife / Tafelmes	305	240	5061106
	Steak Knife / Steakmes	315	240	5097952
	Table Fork / Tafelvork	320	205	5061274
	Table Spoon / Tafellepel	325	205	5061168
	Dessert Knife Hollow Handle / Dessertmes Holheft	330	220	5061113
	Dessert Knife / Dessertmes	335	215	5061120
	Dessert Fork / Dessertvork	340	187	5061281
	Dessert Spoon / Dessertlepel	345	186	5061175
	Fruit/Cocktail Knife / Fruit/Cocktail Mes	360	184	5061137
	Medium Teaspoon / Koffielepel	375	142	5061182
	Mocca Spoon / Theelepel	380	104	5061229
	Cake Fork / Gebakvork	390	143	5061298
	Fish Knife / Vismes	410	218	5061236
	Fish Fork / Visvork	415	181	5061243



# 5280 DUKE



CUTLERY  
AMEFA PREMIERE

**THICKNESS:**  
3,5 mm

**MATERIAL:**  
18-10

**FINISH:**  
mirror/hoogglans

	DESCRIPTION	CODE	LENGTH MM	BARCODE 871115
	Table knife hollow handle / tafelmes holheft	300	242	5132462
	Table knife / tafelmes	305	234	5135470
	Table fork / tafelvork	320	200	5137474
	Table spoon / tafellepel	325	199	5137511
	Dessert knife / dessertmes	335	225	5135951
	Dessert fork / dessertvork	341	186	5137924
	Dessert spoon / dessertlepel	346	189	5137894
	Round Soup Spoon / dessertlepel ronde bak	350	173	5020271
	Medium teaspoon / koffielepel	375	137	5141655
	Mocca spoon / theelepel	380	123	5142263
	Cake fork / Gebakvork	390	148	5141433
	Fish knife / vismes	410	197	5137467
	Fish fork / visvork	415	183	5137627



# 8010 JEWEL



CUTLERY  
AMEFA PREMIERE



**THICKNESS:**  
3,0 mm

**MATERIAL:**  
18-10

**FINISH:**  
mirror/hoogglans

	DESCRIPTION	CODE	LENGTH MM	BARCODE 871115
	Table knife / tafelmes	305	236	5370451
	Table fork / tafelvork	320	207	5370482
	Table spoon / tafellepel	325	204	5370512
	Dessert Knife / dessertmes	335	210	5371243
	Dessert fork / dessertvork	340	190	5371274
	Dessert spoon / dessertlepel	345	189	5371304
	Round Soup Spoon / dessertlepel ronde bak	350	178	5373568
	Medium teaspoon / koffielepel	375	150	5370543
	Large Teaspoon / koffielepel groot	378	167	5451389
	Mocca spoon / theelepel	380	117	5373605
	Cake fork / gebakvorkje	390	150	5373636
	Fish knife / vismes	410	210	5406150
	Butterspreader / botermes	470	153	5420040





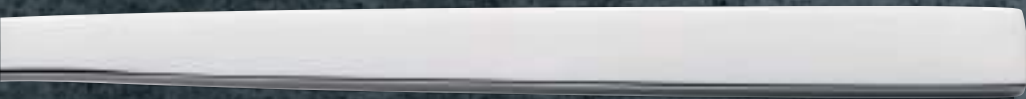









# 8020 CUBE



**THICKNESS:**  
4,5 mm

**MATERIAL:**  
18-10

**FINISH:**  
mirror/hoogglans

	DESCRIPTION	CODE	LENGTH MM	BARCODE 871115
	Table Knife / tafelmes	305	235	5376613
	Table fork / tafelvork	320	211	5376644
	Table spoon / tafellepel	325	210	5376675
	Dessert Knife / dessertmes	335	204	5376705
	Dessert fork / dessertvork	340	187	5376736
	Dessert spoon / dessertlepel	345	186	5376767
	Fruit knife / fruit-/cocktailmesje	360	173	5376798
	Medium teaspoon / koffielepel	375	142	5376828
	Large Teaspoon / koffielepel groot	378	166	5451419
	Mocca spoon / theelepel	380	112	5376859
	Cake fork / gebakvorkje	390	154	5376880
	Iced Teaspoon / sorbetlepel	400	194	5376910
	Fish knife / vismes	410	207	5376941
	Fish fork / visvork	415	182	5376972



# 8050 DRIFT













CUTLERY  
AMEFA PREMIERE



**THICKNESS:**  
3,0 mm

**MATERIAL:**  
18-10

**FINISH:**  
mirror/hoogglans

	DESCRIPTION	CODE	LENGTH MM	BARCODE 871115
	Table knife / tafelmes	305	235	5457503
	Table fork / tafelvork	320	208	5457534
	Table spoon / tafellepel	325	207	5457565
	Dessert Knife / dessertmes	335	213	5458067
	Dessert fork / dessertvork	340	185	5458159
	Dessert spoon / dessertlepel	345	185	5458180
	Round Soup Spoon / dessertlepel ronde bak	350	178	5465607
	Fruit knife / fruit-/cocktailmesje	360	169	5466871
	Medium teaspoon / koffielepel	375	144	5457596
	Large Teaspoon / koffielepel groot	378	166	5457596
	Mocca spoon / theelepel	380	117	5458098
	Cake fork / gebakvorkje	390	144	5458128
	Iced Teaspoon / sorbetlepel	400	190	5465577



# 8051 SIERRA



**THICKNESS:**  
3,0 mm

**MATERIAL:**  
18-10

**FINISH:**  
mirror/hoogglans

	DESCRIPTION	CODE	LENGTH MM	BARCODE 871115
	Table Knife / tafelmes	305	235	5484608
	Table Fork / tafelvork	320	208	5484639
	Table Spoon / tafellepel	325	207	5484660
	Dessert Knife / dessertmes	335	213	5484691
	Dessert Fork / dessertvork	340	185	5484721
	Dessert Spoon / dessertlepel	345	185	5484752
	Medium Teaspoon / koffielepel	375	144	5484783
	Mocca spoon / theelepel	380	117	5484813
	Cake Fork / gebakvork	390	144	5484844
	Iced Teaspoon / Sorbetlepel	400	190	5496854



# 8060 TOKYO













CUTLERY  
AMEFA PREMIERE



**THICKNESS:**  
4,0 mm

**MATERIAL:**  
18-10

**FINISH:**  
mirror/hoogglans PVD

	DESCRIPTION	CODE	LENGTH MM	BARCODE 871115
	Table Knife Hollow Handle / Tafelmes Holheft	301	235	5272199
	Table Knife / Tafelmes	305	235	5374091
	Table Fork / Tafelvork	320	205	5272144
	Table Spoon / Tafellepel	325	205	5272236
	Dessert Knife Hollow Handle / Dessertmes Holheft	331	205	5272267
	Dessert Fork / Dessertvork	340	184	5272328
	Dessert Spoon / Dessertlepel	345	183	5272359
	Fruit/Cocktail Knife / Fruit/Cocktail Mes	360	174	5272687
	Medium Teaspoon / Koffielepel	375	140	5272113
	Mocca Spoon / Theelepel	380	115	5272380
	Cake Fork / Gebakvork	390	146	5272410
	Fish Knife / Vismes	410	203	5272748
	Fish Fork / Visvork	415	184	5272717









# 8310 OPUS



**THICKNESS:**  
3,5 mm

**MATERIAL:**  
18-10

**FINISH:**  
mirror/hoogglans

	DESCRIPTION	CODE	LENGTH MM	BARCODE 354669
	Table Knife / Tafelmes	305	226	0100912
	Table Fork / Tafelvork	320	205	0100943
	Table Spoon / Tafellepel	325	205	0100929
	Dessert Knife / Dessertmes	335	200	0100776
	Dessert Fork / Dessertvork	340	182	0100806
	Dessert Spoon / Dessertlepel	345	182	0100790
	Round Soup Spoon / Dessertlepel Ronde Bak	350	184	0101209
	Medium Teaspoon / Koffielepel	375	137	0100936
	Cake Fork / Gebakvork	390	155	0100875



# 8330 VENUS







CUTLERY  
AMEFA PREMIERE



**THICKNESS:**  
3,0 mm

**MATERIAL:**  
18-10

**FINISH:**  
mirror/hoogglans

	DESCRIPTION	CODE	LENGTH MM	BARCODE 354669
	Table Knife / tafelmess	305	238	0830918
	Table Fork / tafelvork	320	208	0830949
	Table Spoon / tafellepel	325	208	0830925
	Dessert Knife / dessertmess	335	215	0830772
	Dessert Fork / dessertvork	340	187	0830802
	Dessert Spoon / dessertlepel	345	187	0830796
	Medium Teaspoon / koffielepel	375	144	0830932
	Mocca spoon / theelepel	380	117	0830833
	Cake Fork / gebakvork	390	144	0820872



## Venus

Cutlery model **Venus** combines classic round shapes with a contemporary look and feel. Now available in a mirror as well as a stunning velvet finish, gold PVD and black PVD for a touch of luxury at any table. This series is made of high-quality chrome nickel steel, better known as 18-10 stainless steel. Venus is dishwasher safe and built to last.

### Unique selling points



### Overview finishes Venus



Mirror



Velvet



Black



Gold

# 8330

## VENUS BLACK



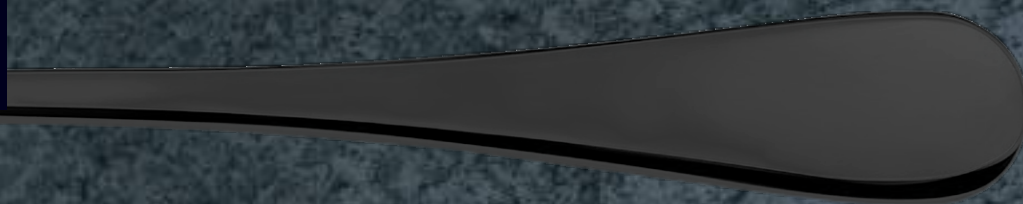



CUTLERY  
AMEFA PREMIERE



**THICKNESS:**  
3,0 mm

**MATERIAL:**  
18-10

**FINISH:**  
mirror/hoogglans

	DESCRIPTION	CODE	LENGTH MM	BARCODE 871115
	Table Knife / tafelmess	305	238	5515104
	Table Fork / tafelvork	320	208	5515135
	Table Spoon / tafellepel	325	208	5515166
	Dessert Knife / dessertmess	335	215	5515197
	Dessert Fork / dessertvork	340	187	5515227
	Dessert Spoon / dessertlepel	345	187	5515258
	Medium Teaspoon / koffielepel	375	144	5515289
	Mocca spoon / theelepel	380	117	5515319
	Cake Fork / gebakvork	390	144	5515340





# 8330 VENUS GOLD



**THICKNESS:**  
3,0 mm

**MATERIAL:**  
18-10

**FINISH:**  
mirror/hoogglans

	DESCRIPTION	CODE	LENGTH MM	BARCODE 871115
	Table Knife / tafelmes	305	238	5515371
	Table Fork / tafelvork	320	208	5515401
	Table Spoon / tafellepel	325	208	5515432
	Dessert Knife / dessertmes	335	215	5515463
	Dessert Fork / dessertvork	340	187	5515494
	Dessert Spoon / dessertlepel	345	187	5515524
	Medium Teaspoon / koffielepel	375	144	5515555
	Mocca spoon / theelepel	380	117	5515586
	Cake Fork / gebakvork	390	144	5515616



# 8330

## VENUS VELVET



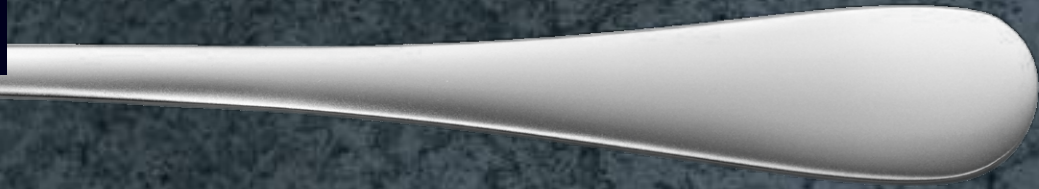





CUTLERY  
AMEFA PREMIERE



**THICKNESS:**  
3,0 mm

**MATERIAL:**  
18-10

**FINISH:**  
velvet

	DESCRIPTION	CODE	LENGTH MM	BARCODE 871115
	Table Knife / tafelmess	305	238	5515913
	Table Fork / tafelvork	320	208	5515944
	Table Spoon / tafellepel	325	208	5515975
	Dessert Knife / dessertmess	335	215	5516002
	Dessert Fork / dessertvork	340	187	5516033
	Dessert Spoon / dessertlepel	345	187	5516064
	Medium Teaspoon / koffielepel	375	144	5516095
	Mocca spoon / theelepel	380	117	5516125
	Cake Fork / gebakvork	390	144	5516156









# 8340 ORPHEE

CUTLERY  
AMEFA PREMIERE

**THICKNESS:**  
3,5 mm

**MATERIAL:**  
18-10

**FINISH:**  
mirror/hoogglans

	DESCRIPTION	CODE	LENGTH MM	BARCODE 354669
	Table Knife / tafelmes	305	226	0820919
	Table Fork / tafelvork	320	203	0820940
	Table Spoon / tafellepel	325	205	0820926
	Dessert Knife / dessertmes	335	203	0820773
	Dessert Fork / dessertvork	340	182	0820803
	Dessert Spoon / dessertlepel	345	182	0820797
	Medium Teaspoon / koffielepel	375	149	0820933
	Mocca spoon / theelepel	380	115	0820834







# 8090 NEWTON



**THICKNESS:**  
8,0 mm/forged

**MATERIAL:**  
18-10

**FINISH:**  
mirror/hoogglans

	DESCRIPTION	CODE	LENGTH MM	BARCODE 871115
	Table Knife / tafelmes	305	240	5135401
	Table Fork / tafelvork	320	204	5135296
	Table Spoon / tafellepel	325	205	5135333
	Dessert Knife / dessertmes	335	209	5136255
	Dessert Fork / dessertvork	340	184	5136262
	Dessert Spoon / dessertlepel	345	184	5136279
	Round Soup Spoon / dessertlepel ronde bak	350	171	5136286
	Fruit knife / fruit-/cocktailmesje	360	185	5137504
	Medium Teaspoon / koffielepel	375	137	5139898
	Mocca Spoon / theelepel	380	115	5141273
	Cake Fork / gebakvork	390	145	5139683





















# 9065 AURORA

CUTLERY  
AMEFA PREMIERE

**THICKNESS:**  
3,5 mm

**MATERIAL:**  
18-10

**FINISH:**  
mirror/hoogglans

	DESCRIPTION	CODE	LENGTH MM	BARCODE 871115
	Table Knife / tafelmes	305	223	5135432
	Steak Knife / steakmes	315	223	5135425
	Table Fork / tafelvork	320	202	5138853
	Table Spoon / tafellepel	325	204	5138792
	Dessert Knife / dessertmes	335	206	5135937
	Dessert Fork / dessertvork	340	190	5139584
	Dessert Spoon / dessertlepel	345	190	5139508
	Round Soup Spoon / dessertlepel ronde bak	350	185	5139553
	Fruit/Cocktail Knife / fruit/cocktail mes	360	178	5137962
	Medium Teaspoon / koffielepel	375	134	5142805
	Mocca Spoon / theelepel	380	115	5143178
	Cake Fork / gebakvork	390	140	5142461
	Iced Teaspoon / sorbetlepel	400	180	5140252
	Iced Teaspoon Bent / sorbetlepel gebogen	410	211	5138785
	Fish Knife / vismes	410	211	5138785
	Gravy Ladle / sauslepel	430	180	5132165
	Vegetable Spoon / groentelepel	435	218	5134817
	Cake Server / gebakschep	455	256	5134794



# 9090 TENDENCE



**THICKNESS:**  
4,0 mm

**MATERIAL:**  
18-10

**FINISH:**  
mirror/hoogglans

	DESCRIPTION	CODE	LENGTH MM	BARCODE 871115
	Table Knife / Tafelmes	305	232	5057598
	Steak Knife / Steakmes	315	230	5062769
	Table Fork / Tafelvork	320	203	5057628
	Table Spoon / Tafellepel	325	200	5057604
	Dessert Knife / Dessertmes	335	210	5062776
	Dessert Fork / Dessertvork	340	184	5062820
	Dessert Spoon / Dessertlepel	345	184	5062806
	Fruit/Cocktail Knife / Fruit/ Cocktail Mes	360	185	5059684
	Medium Teaspoon / Koffielepel	375	142	5057611
	Mocca Spoon / Theelep	380	110	5059738
	Cake Fork / Gebakvork	390	145	5059783



# AMEFA 18-10 COLLECTION

Everybody can dine together at the Amefa table. Choice and value go hand in hand, so you can be sure that whatever your budget, we've got a cutlery set that suits your taste. What makes Amefa stand out is our passion for lasting quality and craftsmanship. We don't cut corners and our cutlery is beautiful down to the very last detail.



Amefa

# 1026 COLORADO







CUTLERY  
AMEFA 18-10



**THICKNESS:**  
8,0 mm/forged

**MATERIAL:**  
18-10

**FINISH:**  
mirror/hoogglans

	DESCRIPTION	CODE	LENGTH MM	BARCODE 871115
	Table knife / tafelmes	305	222	5071341
	Table fork / tafelvork	320	201	5071372
	Table spoon / tafellepel	325	204	5071358
	Dessert knife / dessertmes	335	201	5090908
	Dessert fork / dessertvork	340	184	5090915
	Dessert spoon / dessertlepel	345	179	5090922
	Round soup spoon / dessertlepel ronde bak	350	173	5108535
	Fruit/cocktail knife	360	170	5123378
	Medium teaspoon / koffielepel	375	140	5071365
	Mocca spoon / theelepel	380	119	5090939
	Cake fork / gebakvork	390	142	5090946
	Cake server	455	248	5091028



# 1120 CUBA



**THICKNESS:**



















6,0 mm/forged

**MATERIAL:**

18-10

**FINISH:**

mirror/hoogglans

	DESCRIPTION	CODE	LENGTH MM	BARCODE 871115
	Table knife / tafelmes	305	240	5116929
	Steak knife / steakmes	315	180	5117070
	Table fork / tafelvork	320	216	5116936
	Table spoon / tafellepel	325	220	5116943
	Dessert knife / dessertmes	335	213	5116950
	Dessert fork / dessertvork	340	200	5116967
	Dessert spoon / dessertlepel	345	200	5116974
	Round soup spoon / dessertlepel ronde bak	350	192	5117049
	Medium teaspoon / koffielepel	375	138	5116981
	Mocca spoon / theelepel	380	110	5117025
	Cake fork / gebakvork	390	148	5117063
	Fish knife / vismes	410	200	5116998
	Fish fork / visvork	415	190	5117001
	Soup ladle / soeplepel	425	306	5117032
	Gravy ladle / sauslepel	430	197	5117018
	Vegetable spoon / groentelepel	435	221	5117117
	Salad serving fork / sladienvork	445	221	5117094
	Salad serving spoon / saladelepel	450	235	5117100
	Cake server / gebakschep	455	231	5117087

















# 1316 MARTIN

CUTLERY  
AMEFA 18-10

**THICKNESS:**  
3,0 mm

**MATERIAL:**  
18-10

**FINISH:**  
mirror/hoogglans

	DESCRIPTION	CODE	LENGTH MM	BARCODE 871115
	Table Knife / tafelmes	305	230	5339656
	Table Fork /tafelvork	320	219	5339687
	Table Spoon / Tafellepel	325	204	5339717
	Dessert knife / dessertmes	335	209	5339748
	Dessert fork / dessertvork	340	201	5339779
	Dessert spoon / dessertlepel	345	182	5339809
	Medium teaspoon / koffielepel	375	150	5339861
	Mocca spoon / theelepel	380	115	5339892
	Cake fork / gebakvork	390	153	5339922
	Gravy ladle / sauslepel	430	186	5340041
	Vegetable Spoon / groentelepel	435	210	5340072
	Salad serving fork / sladienvork	445	240	5340102
	Salad serving spoon / sladienlepel	450	240	5340133
	Cake server / gebakschep	455	225	5340164





















# 1923 MODERNO



**THICKNESS:**  
2,5 mm

**MATERIAL:**  
18-10

**FINISH:**  
mirror/hoogglans

	DESCRIPTION	CODE	LENGTH MM	BARCODE 871115
	Table knife / tafelmes	305	228	5107897
	Table fork / tafelvork	320	201	5107910
	Table spoon / tafellepel	325	201	5107927
	Dessert knife / dessertmes	335	214	5107934
	Dessert fork / dessertvork	340	190	5107941
	Dessert spoon / dessertlepel	345	190	5107958
	Round soup spoon / dessertlepel ronde bak	350	190	5107965
	Fruit/cocktail knife / fruit-/cocktailmesje	360	165	5109112
	Medium teaspoon / koffielepel	375	132	5107972
	Mocca spoon / theelepel	380	110	5107989
	Cake fork / gebakvork	390	98	5361251
	Iced teaspoon / sorbetlepel	400	202	5109679
	Fish knife / vismes	410	210	5109129
	Gravy ladle / sauslepel	430	185	5112976
	Vegetable spoon / groentelepel	435	225	5108009
	Salad serving fork / sladienvork	445	235	5108016
	Salad serving spoon / sladienlepel	450	235	5108023
	Cake server / gebakschep	455	250	5108030































# 1810 FLORENCE

CUTLERY  
AMEFA 18-10

**THICKNESS:**  
3,0 mm

**MATERIAL:**  
18-10

**FINISH:**  
mirror/hoogglans

	DESCRIPTION	CODE	LENGTH MM	BARCODE 871115
	Table knife / tafelmes	305	218	5006565
	Table fork / tafelvork	320	198	5006589
	Table spoon / tafellepel	325	199	5006572
	Dessert knife / dessertmes	335	195	5006596
	Dessert fork / dessertvork	340	177	5006619
	Dessert spoon / dessertlepel	345	180	5006602
	Fruit knife / fruit-/cocktailmesje	360	166	5002543
	Medium teaspoon / koffielepel	375	138	5010005
	Large tea spoon / koffielepel groot	378	153	5034322
	Mocca spoon / theelepel	380	112	5010012
	Liquor - espresso spoon / likeur - espresso lepel	385	96	5012795
	Cake fork / gebakvork	390	155	5010036
	Cake fork small / gebakvork klein	391	122	5010029
	Salad fork/cocktailfork / slavorkje	395	157	5034339
	Iced teaspoon / sorbetlepel	400	188	5010043
	Oyster fork / oestervorkje	420	137	5038146
	Lobster fork / kreeftvork	423	226	5099741
	Soup ladle / soeplepel	425	319	5110074
	Gravy ladle / sauslepel	430	187	5006626
	Vegetable spoon / groentelepel	435	213	5006633
	Potato spoon / aardappel lepel	440	210	5006640
	Salad serving fork / sladienvork	445	210	5010395
	Salad serving spoon / sladienlepel	450	212	5010111
	Cake server / gebakschep	455	257	5010081
	Ice-creamspoon/sugar spoon/ ijs-/suikerschepje	464	135	5012788
	Butter spreader / botermesje	470	153	5010098
	Amuse spoon small / amuselepel klein	561	115	5260158
	Table knife heavy execution / tafelmes extra zwaar	605	227	5519348
	Dessert knife heavy execution / dessertmes extra zwaar	635	205	5519379























# 1824 ATLANTIC



**THICKNESS:**  
2,5 mm

**MATERIAL:**  
18-10

**FINISH:**  
mirror/hoogglans

	DESCRIPTION	CODE	LENGTH MM	BARCODE 871115
	Table knife / tafelmess	305	208	5042952
	Steak knife / steakmes	315	218	5022046
	Table fork / tafelvork	320	189	5042945
	Table spoon / tafellepel	325	192	5042938
	Dessert knife / dessertmes	335	194	5050902
	Dessert fork / dessertvork	340	178	5002604
	Dessert spoon / dessertlepel	345	180	5020844
	Round soup spoon / dessertlepel ronde bak	350	184	5020790
	Fruit knife / fruit-/cocktailmesje	360	175	5059318
	Cocktail spoon / cocktaillepel	370	155	5020820
	Medium teaspoon / koffielepel	375	138	5042969
	Mocca spoon / theelepel	380	108	5024651
	Cake fork / gebakvork	390	150	5042976
	Iced teaspoon / sorbetlepel	400	177	5010715
	Soup ladle / soeplepel	425	299	5022053
	Gravy ladle / sauslepel	430	175	5074786
	Salad serving fork / sladienvork	448	239	5022084
	(Salad) serving spoon / (sla)dienlepel	453	239	5022077
	Cake server / gebakschep	455	232	5074779
	Small meat fork / vleesvorkje	476	143	5099451
	Amuse spoon regular / amuselepel	560	120	5060147



# 1924 VENTURA

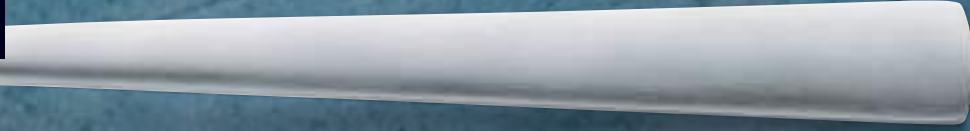

CUTLERY  
AMEFA 18-10



**THICKNESS:**  
3,0 mm

**MATERIAL:**  
18-10

**FINISH:**  
satin/matt

	DESCRIPTION	CODE	LENGTH MM	BARCODE 871115
	Table knife / tafelmes	305	228	5059912
	Table fork / tafelvork	320	201	5059936
	Table spoon / tafellepel	325	201	5059929
	Dessert knife / dessertmes	335	214	5065319
	Dessert fork / dessertvork	340	190	5065395
	Dessert spoon / dessertlepel	345	190	5065326
	Round soup spoon / dessertlepel ronde bak	350	187	5075721
	Medium teaspoon / koffielepel	375	132	5059943
	Mocca spoon / theelepel	380	110	5021063
	Cake fork / gebakvork	390	156	5065401
	Gravy ladle / sauslepel	430	185	5065333
	Vegetable spoon / groentelepel	435	225	5065340
	Salad serving fork / sladienvork	445	235	5065388
	Salad serving spoon / sladienlepel	450	235	5065371
	Cake server / gebakschep	455	250	5066750



# 1924 VENTURA BLACK

**THICKNESS:**  
3,0 mm

**MATERIAL:**  
18-10

**FINISH:**  
satin/matt PVD

	DESCRIPTION	CODE	LENGTH MM	BARCODE 871115
	Table knife / tafelmes	305	228	5430254
	Table fork / tafelvork	320	201	5430285
	Table spoon / tafellepel	325	201	5430315
	Dessert knife / dessertmes	335	214	5430346
	Dessert fork / dessertvork	340	190	5430377
	Dessert spoon / dessertlepel	345	190	5430407
	Round soup spoon / dessertlepel ronde bak	350	187	5500704
	Medium teaspoon / koffielepel	375	132	5430438
	Mocca spoon / theelepel	380	110	5430469
	Cake fork / gebakvork	390	156	5443582



# 1924

# VENTURA GOLD

CUTLERY  
AMEFA 18-10



**THICKNESS:**  
3,0 mm

**MATERIAL:**  
18-10

**FINISH:**  
satin/matt PVD

	DESCRIPTION	CODE	LENGTH MM	BARCODE 871115
	Table knife / tafelmes	305	228	5430490
	Table fork / tafelvork	320	201	5430520
	Table spoon / tafellepel	325	201	5430551
	Dessert knife / dessertmes	335	214	5430582
	Dessert fork / dessertvork	340	190	5430612
	Dessert spoon / dessertlepel	345	190	5430643
	Round soup spoon / dessertlepel ronde bak	350	187	5500735
	Medium teaspoon / koffielepel	375	132	5430674
	Mocca spoon / theelepel	380	110	5430704
	Cake fork / gebakvork	390	156	5443612



# 1924 VENTURA COPPER



**THICKNESS:**  
3,0 mm

**MATERIAL:**  
18-10

**FINISH:**  
satin/matt PVD

	DESCRIPTION	CODE	LENGTH MM	BARCODE 871115
	Table knife / tafelmes	305	228	5430018
	Table fork / tafelvork	320	201	5430049
	Table spoon / tafellepel	325	201	5430070
	Dessert knife / dessertmes	335	214	5430100
	Dessert fork / dessertvork	340	190	5430131
	Dessert spoon / dessertlepel	345	190	5430162
	Round soup spoon / dessertlepel ronde bak	350	187	5500674
	Medium teaspoon / koffielepel	375	132	5430193
	Mocca spoon / theelepel	380	110	5430223
	Cake fork / gebakvork	390	156	5434788



# 1924

# VENTURA CHAMPAGNE

CUTLERY  
AMEFA 18-10



**THICKNESS:**  
3,0 mm

**MATERIAL:**  
18-10

**FINISH:**  
satin/matt PVD

	DESCRIPTION	CODE	LENGTH MM	BARCODE 871115
	Table knife / tafelmess	305	228	5445739
	Table fork / tafelvork	320	201	5445760
	Table spoon / tafellepel	325	201	5445791
	Dessert knife / dessertmess	335	214	5445821
	Dessert fork / dessertvork	340	190	5445852
	Dessert spoon / dessertlepel	345	190	5445883
	Round soup spoon / dessertlepel ronde bak	350	187	5500766
	Medium teaspoon / koffielepel	375	132	5445913
	Mocca spoon / theelepel	380	110	5445944
	Cake fork / gebakvork	390	156	5445975





# 7204 ELEGANCE

















CUTLERY  
AMEFA 18-10



**THICKNESS:**  
2,5 mm

**MATERIAL:**  
18-10

**FINISH:**  
mirror/hoogglans

	DESCRIPTION	CODE	LENGTH MM	BARCODE 871115
	Table knife / tafelmes	305	215	5006923
	Steak knife long blade / steakmes lang lemmet	318	236	5011224
	Table fork / tafelvork	320	197	5006947
	Table spoon / tafellepel	325	199	5006930
	Dessert knife / dessertmes	335	199	5006954
	Dessert fork / dessertvork	340	174	5006961
	Dessert spoon / dessertlepel	345	177	5006978
	Round soup spoon / dessertlepel ronde bak	350	167	5019152
	Fruit knife / fruit-/cocktailmesje	360	171	5010319
	Medium teaspoon / koffielepel	375	144	5009122
	Large tea spoon/ koffielepel groot/cocktaillepel	378	152	5032458
	Mocca spoon / theelepel	380	121	5010333
	Cake fork / gebakvork	390	147	5010371
	Salad fork/cocktailfork / slavorkje	395	157	5010326
	Iced teaspoon / sorbetlepel	400	184	5011910
	Butter spreader / botermesje	470	146	5010357





# 8410 PALMON

CUTLERY  
AMEFA 18-10



**THICKNESS:**  
2,5 mm

**MATERIAL:**  
18-10

**FINISH:**  
mirror/hoogglans

	DESCRIPTION	CODE	LENGTH MM	BARCODE 871115
	Table knife / tafelmes	305	218	5032045
	Table fork / tafelvork	320	194	5032069
	Table spoon / tafellepel	325	195	5032052
	Dessert knife / dessertmes	335	201	5050896
	Dessert fork / dessertvork	340	176	5061892
	Dessert spoon / dessertlepel	345	177	5058489
	Medium teaspoon / koffielepel	375	132	5032076
	Mocca spoon / theelepel	380	112	5044666
	Cake fork / gebakvork	390	154	5042921



# 8420 SONATE



**THICKNESS:**  
2,5 mm

**MATERIAL:**  
18-10

**FINISH:**  
mirror/hoogglans

	DESCRIPTION	CODE	LENGTH MM	BARCODE 871115
	Table knife / tafelmes	305	220	5032083
	Table fork / tafelvork	320	193	5032106
	Table spoon / tafellepel	325	193	5032090
	Dessert knife / dessertmes	335	201	5061922
	Dessert fork / dessertvork	340	176	5062042
	Dessert spoon / dessertlepel	345	171	5061953
	Medium teaspoon / koffielepel	375	130	5032113
	Mocca spoon / theelepel	380	111	5061991
	Cake fork / gebakvork	390	153	5032229
	Cake server / gebakschep	455	240	5061946



# 8430 HAYDN

CUTLERY  
AMEFA 18-10



**THICKNESS:**  
2,5 mm

**MATERIAL:**  
18-10

**FINISH:**  
mirror/hoogglans

	DESCRIPTION	CODE	LENGTH MM	BARCODE 871115
	Table knife heavy execution / tafelmes extra zwaar	605	245	5064220
	Table fork / tafelvork	320	203	5049579
	Table spoon / tafellepel	325	204	5049487
	Dessert knife heavy execution / dessertmes extra zwaar	635	210	5066187
	Dessert fork / dessertvork	340	183	5049586
	Dessert spoon / dessertlepel	345	184	5049494
	Round soup spoon / dessertlepel ronde bak	350	176	5062066
	Fruit knife / fruit-/cocktailmesje	360	180	5062059
	Medium teaspoon / koffielepel	375	133	5049500
	Mocca spoon / theelepel	380	112	5049555
	Cake fork / gebakvork	390	155	5049593
	Gravy ladle / sauslepel	430	164	5049524
	Salad serving fork / sladienvork	445	226	5062097





















# 8440 BAGUETTE



**THICKNESS:**  
2,5 mm

**MATERIAL:**  
18-10

**FINISH:**  
mirror/hoogglans



















	DESCRIPTION	CODE	LENGTH MM	BARCODE 871115
	Table knife / tafelmes	305	245	5049609
	Table fork / tafelvork	320	209	5049753
	Table spoon / tafellepel	325	209	5049647
	Dessert knife / dessertmes	335	215	5049616
	Dessert fork / dessertvork	340	185	5049760
	Dessert spoon / dessertlepel	345	180	5049654
	Round soup spoon / dessertlepel ronde bak	350	172	5070528
	Small knife-butter spreader / klein mes-boter mesje	360	183	5049623
	Medium teaspoon / koffielepel	375	139	5049661
	Mocca spoon / theelepel	380	125	5049708
	Cake fork / gebakvork	390	140	5049777
	Iced teaspoon / sorbetlepel	400	187	5007852
	Fish knife / vismes	410	204	5049715
	Fish fork / visvork	415	185	5049722
	Gravy ladle / sauslepel	430	190	5049685
	Vegetable spoon / groentelepel	435	205	5049692
	Salad serving fork / sladienvork	445	205	5049746
	Salad serving spoon / sladienlepel	450	205	5049739
	Cake server / gebakschep	455	253	5049630



8440

## BAGUETTE STONEWASH

CUTLERY  
AMEFA 18-10**THICKNESS:**  
2,5 mm**MATERIAL:**  
18-10**FINISH:**  
stonewash

	DESCRIPTION	CODE	LENGTH MM	BARCODE 871115
	Table knife / tafelmes	305	245	5425434
	Table fork / tafelvork	320	209	5425465
	Table spoon / tafellepel	325	209	5425496
	Dessert knife / dessertmes	335	215	5425526
	Dessert fork / dessertvork	340	185	5425557
	Dessert spoon / dessertlepel	345	180	5425588
	Round soup spoon / dessertlepel ronde bak	350	172	5521440
	Small knife-butter spreader / Klein mes-boter mesje	360	183	5513780
	Medium teaspoon / koffielepel	375	139	5425618
	Mocca spoon / theelepel	380	125	5425649
	Cake fork / gebakvork	390	140	5425670
	Iced teaspoon / sorbetlepel	400	187	5425670
	Fish knife / vismes	410	204	5437703
	Fish fork / visvork	415	185	5521471
	Gravy ladle / sauslepel	430	190	5521501
	Vegetable spoon / groentelepel	435	205	5521532
	Salad serving fork / sladienvork	445	205	5521563
	Salad serving spoon / sladienlepel	450	205	5521594
	Cake server / gebakschep	455	253	5521624





# AMEFA 18/0 COLLECTION



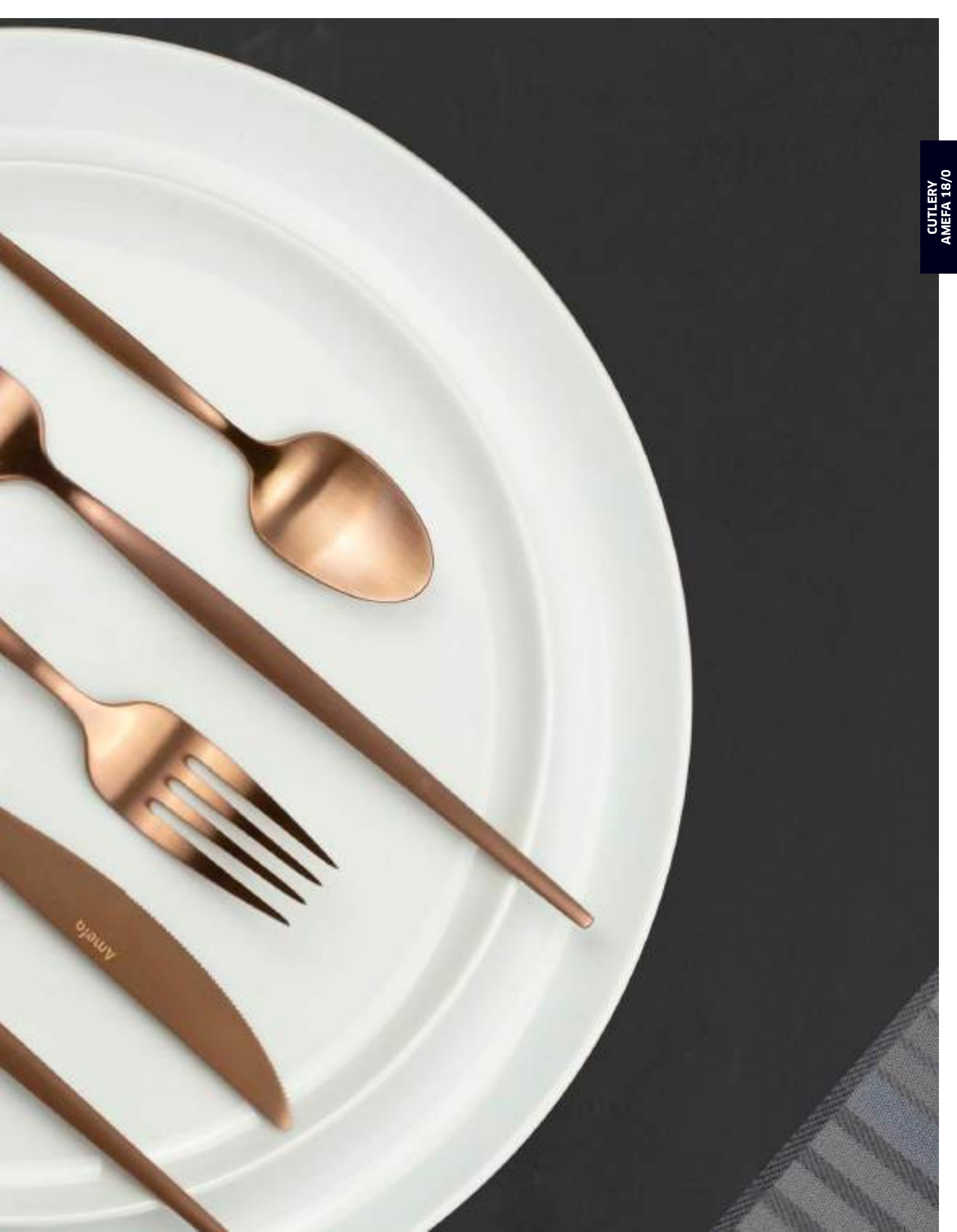





















# 0900 FILET



**THICKNESS:**  
2,2 mm

**MATERIAL:**  
18/0

**FINISH:**  
mirror/hoogglans

	DESCRIPTION	CODE	LENGTH MM	BARCODE 871115
	Table knife / tafelmes	305	239	5004660
	Table fork / tafelvork	320	213	5004752
	Table spoon / tafellepel	325	204	5006831
	Dessert knife / dessertmes	335	214	5006848
	Dessert fork / dessertvork	340	180	5006862
	Dessert spoon / dessertlepel	345	182	5006855
	Fruit/cocktail knife / fruit-/cocktailmesje	360	170	5016441
	Medium teaspoon / koffielepel	375	135	5004769
	Large tea spoon / koffielepel groot/cocktaillepel	378	150	5026037
	Mocca spoon / theelepel	380	113	5009832
	Liquor spoon / likeurlepel	385	92	5009849
	Cake fork / gebakvork	390	139	5009863
	Iced teaspoon / sorbetlepel	400	185	5009870
	Gravy ladle / sauslepel	430	183	5006879
	Vegetable spoon / groentelepel	435	246	5006886
	Potato spoon / aardappelpepel	440	210	5006983
	Cake server / gebakschep	455	249	5009924
	Butter spreader / botermesje	470	151	5009948
	Cocktail fork/ cocktail vorkje	545	141	5009818



# 1114 SOPRANO



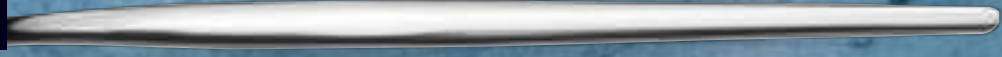







CUTLERY  
AMEFA 18/0



**THICKNESS:**  
4,0 mm

**MATERIAL:**  
18/0

**FINISH:**  
mirror/hoogglans

	DESCRIPTION	CODE	LENGTH MM	BARCODE
	Table Knife / tafelmtes	305	230	3546690461914
	Table Fork / tafelvork	320	203	3546690461945
	Table Spoon / tafellepel	325	203	3546690461921
	Dessert knife / dessertmes	335	207	8711155503484
	Dessert fork / dessertvork	340	183	8711155503514
	Dessert spoon / dessertlepel	345	183	8711155503545
	Medium teaspoon / koffielepel	375	150	3546690461938
	Mocca spoon / theelepel	380	110	8711155503576
	Cake fork / gebakvork	390	155	8711155503606
	Iced teaspoon / sorbetlepel	400	200	8711155503637

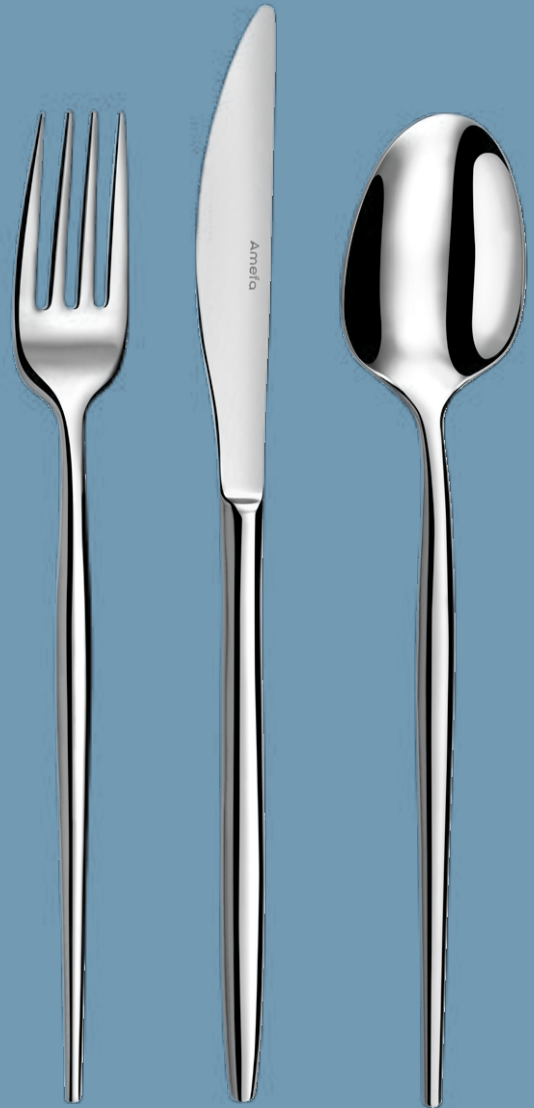











# 1114 SOPRANO COPPER



**THICKNESS:**  
4,0 mm

**MATERIAL:**  
18/0

**FINISH:**  
satin/matt PVD

	DESCRIPTION	CODE	LENGTH MM	BARCODE
	Table Knife / tafelmes	305	230	3546690463918
	Table Fork / tafelvork	320	203	3546690463949
	Table Spoon / tafellepel	325	203	3546690463925
	Dessert knife / dessertmes	335	207	8711155504436
	Dessert fork / dessertvork	340	183	8711155504467
	Dessert spoon / dessertlepel	345	183	8711155504498
	Medium teaspoon / koffielepel	375	150	3546690463932
	Mocca spoon / theelepel	380	110	8711155504528
	Cake fork / gebakvork	390	155	8711155504559
	Iced teaspoon / sorbetlepel	400	200	8711155504580



# 1114

## SOPRANO BLACK/GOLD











CUTLERY  
AMEFA 18/0



**THICKNESS:**  
4,0 mm

**MATERIAL:**  
18/0

**FINISH:**  
mirror/hoogglans+  
matt PVD

	DESCRIPTION	CODE	LENGTH MM	BARCODE
	Table Knife / tafelmes	305	230	3546690462911
	Table Fork / tafelvork	320	203	3546690462942
	Table Spoon / tafellepel	325	203	3546690462928
	Dessert knife / dessertmes	335	207	8711155503842
	Dessert fork / dessertvork	340	183	8711155503873
	Dessert spoon / dessertlepel	345	183	8711155503903
	Medium teaspoon / koffielepel	375	150	3546690462935
	Mocca spoon / theelepel	380	110	8711155503934
	Cake fork / gebakvork	390	155	8711155503965
	Iced teaspoon / sorbetlepel	400	200	8711155503996











# 1114 SOPRANO BLACK

**THICKNESS:**  
4,0 mm

**MATERIAL:**  
18/0

**FINISH:**  
mirror/hoogglans+  
matt PVD

	DESCRIPTION	CODE	LENGTH MM	BARCODE
	Table Knife / tafelmess	305	230	3546690460917
	Table Fork / tafelvork	320	203	3546690460948
	Table Spoon / tafellepel	325	203	3546690460924
	Dessert knife / dessertmess	335	207	8711155503668
	Dessert fork / dessertvork	340	183	8711155503699
	Dessert spoon / dessertlepel	345	183	8711155503729
	Medium teaspoon / koffielepel	375	150	3546690460931
	Mocca spoon / theelepel	380	110	8711155503750
	Cake fork / gebakvork	390	155	8711155503781
	Iced teaspoon / sorbetlepel	400	200	8711155503811



# 1410 AUSTIN







CUTLERY  
AMEFA 18/0



**THICKNESS:**  
2,5 mm

**MATERIAL:**  
18/0

**FINISH:**  
mirror/hoogglans

DESCRIPTION	CODE	LENGTH MM	BARCODE 871115
 Table Knife / tafelmes	305	236	5370246
 Table Fork / tafelvork	320	207	5370277
 Table Spoon / tafellepel	325	205	5370314
 Dessert knife / dessertmes	335	212	5372479
 Dessert fork / dessertvork	340	186	5372509
 Dessert spoon / dessertlepel	345	184	5372530
 Round soup spoon / dessertlepel ronde bak	350	168	5373667
 Medium teaspoon / koffielepel	375	142	5370345
 Mocca spoon / theelepel	380	120	5372561
 Cake fork / gebakvork	390	143	5372592
 Iced teaspoon / sorbetlepel	400	205	5400431
 Butter spreader / botermesje	470	172	5483076













# 1410 AUSTIN STONEWASH



**THICKNESS:**  
2,5 mm

**MATERIAL:**  
18/0

**FINISH:**  
stonewash

	DESCRIPTION	CODE	LENGTH MM	BARCODE 871115
	Table Knife / tafelmes	305	236	5407508
	Table Fork / tafelvork	320	207	5407539
	Table Spoon / tafellepel	325	205	5407560
	Dessert knife / dessertmes	335	212	5450641
	Dessert fork / dessertvork	340	186	5450672
	Dessert spoon / dessertlepel	345	184	5450702
	Round soup spoon / dessertlepel ronde bak	350	168	5425380
	Medium teaspoon / koffielepel	375	142	5407591
	Mocca spoon / theelepel	380	120	5450733
	Cake fork / gebakvork	390	143	5450764
	Iced teaspoon / sorbetlepel	400	205	5450795



# 1410 AUSTIN BLACK

CUTLERY  
AMEFA 18/0

**THICKNESS:**  
2,5 mm

**MATERIAL:**  
18/0

**FINISH:**  
satin/matt PVD

	DESCRIPTION	CODE	LENGTH MM	BARCODE 871115
	Table Knife / tafelmes	305	236	5414292
	Table Fork / tafelvork	320	207	5414322
	Table Spoon / tafellepel	325	205	5414353
	Dessert knife / dessertmes	335	212	5468288
	Dessert fork / dessertvork	340	186	5451815
	Dessert spoon / dessertlepel	345	184	5419617
	Round soup spoon / dessertlepel ronde bak	350	168	5466529
	Medium teaspoon / koffielepel	375	142	5414384
	Mocca spoon / theelepel	380	120	5419648
	Cake fork / gebakvork	390	143	5419679
	Iced teaspoon / sorbetlepel	400	205	5419709



# 1410 AUSTIN GOLD



**THICKNESS:**  
2,5 mm

**MATERIAL:**  
18/0

**FINISH:**  
satin/matt PVD

	DESCRIPTION	CODE	LENGTH MM	BARCODE 871115
	Table Knife / tafelmes	305	236	5414414
	Table Fork / tafelvork	320	207	5414438
	Table Spoon / tafellepel	325	205	5414469
	Dessert knife / dessertmes	335	212	5468318
	Dessert fork / dessertvork	340	186	5451785
	Dessert spoon / dessertlepel	345	184	5420682
	Round soup spoon / dessertlepel ronde bak	350	168	5466581
	Medium teaspoon / koffielepel	375	142	5414490
	Mocca spoon / theelepel	380	120	5420712
	Cake fork / gebakvork	390	143	5420743
	Iced teaspoon / sorbetlepel	400	205	5468349



# 1410 AUSTIN COPPER

CUTLERY  
AMEFA 18/0

**THICKNESS:**  
2,5 mm

**MATERIAL:**  
18/0

**FINISH:**  
satin/matt PVD

	DESCRIPTION	CODE	LENGTH MM	BARCODE 871115
	Table Knife / tafelmes	305	236	5414179
	Table Fork / tafelvork	320	207	5414209
	Table Spoon / tafellepel	325	205	5414230
	Dessert knife / dessertmes	335	212	5432609
	Dessert fork / dessertvork	340	186	5432630
	Dessert spoon / dessertlepel	345	184	5419419
	Round soup spoon / dessertlepel ronde bak	350	168	5432661
	Medium teaspoon / koffielepel	375	142	5414261
	Mocca spoon / theelepel	380	120	5419440
	Cake fork / gebakvork	390	143	5419471
	Iced teaspoon / sorbetlepel	400	205	5419501



# 1410 AUSTIN CHAMPAGNE



**THICKNESS:**  
2,5 mm

**MATERIAL:**  
18/0

**FINISH:**  
satin/matt PVD

	DESCRIPTION	CODE	LENGTH MM	BARCODE 871115
	Table Knife / tafelmes	305	236	5456438
	Table Fork / tafelvork	320	207	5456469
	Table Spoon / tafellepel	325	205	5456490
	Dessert knife / dessertmes	335	212	5469988
	Dessert fork / dessertvork	340	186	5470014
	Dessert spoon / dessertlepel	345	184	5457473
	Round soup spoon / dessertlepel ronde bak	350	168	5466550
	Medium teaspoon / koffielepel	375	142	5456520
	Mocca spoon / theelepel	380	120	5457947
	Cake fork / gebakvork	390	143	5457978
	Iced teaspoon / sorbetlepel	400	205	5470045



# 1570 BOLOGNA







CUTLERY  
AMEFA 18/0



**THICKNESS:**  
2.0 mm

**MATERIAL:**  
18/0

**FINISH:**  
mirror/hoogglans

	DESCRIPTION	CODE	LENGTH MM	BARCODE 871115
	Table Knife / tafelmes	305	207	5096658
	Table Fork / tafelvork	320	196	5096665
	Table Spoon / tafellepel	325	195	5096672
	Medium teaspoon / koffielepel	375	144	5096689
	Mocca spoon / theelepel	380	129	5122906
	Cake fork / gebakvork	390	150	5122913
	Iced teaspoon / sorbetlepel	400	196	5122920













# 1933 BLISS



**THICKNESS:**  
2,5 mm

**MATERIAL:**  
18/0

**FINISH:**  
mirror/hoogglans

	DESCRIPTION	CODE	LENGTH MM	BARCODE
	Table Knife / tafelmes	305	225	5015734480115
	Table Fork / tafelvork	320	205	5015734480214
	Table Spoon / tafellepel	325	200	5015734480313
	Dessert knife / dessertmes	335	210	5015734480511
	Dessert fork / dessertvork	340	190	5015734480610
	Dessert spoon / dessertlepel	345	190	5015734480719
	Round soup spoon / dessertlepel ronde bak	350	187	5015734480818
	Medium teaspoon / koffielepel	375	135	5015734480917
	Mocca spoon / theelepel	380	107	8711155465461
	Cake fork / gebakvork	390	155	8711155465492
	Iced teaspoon / sorbetlepel	400	203	8711155465522



# 2515

## PIXEL BLUE LAGOON









CUTLERY  
AMEFA 18/0



**THICKNESS:**  
1,8 mm

**MATERIAL:**  
18/0

**FINISH:**  
mirror/hoogglans  
ABS

	DESCRIPTION	CODE	LENGTH MM	BARCODE 871115
	Table Knife / tafelmes	305	223	5476429
	Table Fork / tafelvork	320	204	5476450
	Table Spoon / tafellepel	325	195	5476481
	Dessert knife / dessertmes	335	193	5477327
	Dessert fork / dessertvork	340	176	5477358
	Dessert spoon / dessertlepel	345	170	5477389
	Medium teaspoon / koffielepel	375	165	5476511
	Cake fork / gebakvork	390	162	5476542











# 2515 PIXEL CHERRY



**THICKNESS:**  
1,8 mm

**MATERIAL:**  
18/0

**FINISH:**  
mirror/hoogglans  
ABS

	DESCRIPTION	CODE	LENGTH MM	BARCODE 871115
	Table Knife / tafelmess	305	223	5476573
	Table Fork / tafelvork	320	204	5476603
	Table Spoon / tafellepel	325	195	5476634
	Dessert knife / dessertmess	335	193	5477419
	Dessert fork / dessertvork	340	176	5477440
	Dessert spoon / dessertlepel	345	170	5477471
	Medium teaspoon / koffielepel	375	165	5476665
	Cake fork / gebakvork	390	162	5476696



# 2515 PIXEL MANGO









CUTLERY  
AMEFA 18/0



**THICKNESS:**  
1,8 mm

**MATERIAL:**  
18/0

**FINISH:**  
mirror/hoogglans  
ABS

	DESCRIPTION	CODE	LENGTH MM	BARCODE 871115
	Table Knife / tafelmes	305	223	5476726
	Table Fork / tafelvork	320	204	5476757
	Table Spoon / tafellepel	325	195	5476788
	Dessert knife / dessertmes	335	193	5477501
	Dessert fork / dessertvork	340	176	5477532
	Dessert spoon / dessertlepel	345	170	5477563
	Medium teaspoon / koffielepel	375	165	5476818
	Cake fork / gebakvork	390	162	5476849











# 2515 PIXEL LEMON



**THICKNESS:**  
1,8 mm

**MATERIAL:**  
18/0

**FINISH:**  
mirror/hoogglans  
ABS

	DESCRIPTION	CODE	LENGTH MM	BARCODE 871115
	Table Knife / tafelmess	305	223	5476870
	Table Fork / tafelvork	320	204	5476900
	Table Spoon / tafellepel	325	195	5476931
	Dessert knife / dessertmess	335	193	5477594
	Dessert fork / dessertvork	340	176	5477624
	Dessert spoon / dessertlepel	345	170	5477655
	Medium teaspoon / koffielepel	375	165	5476962
	Cake fork / gebakvork	390	162	5476993



## Pixel

The PIXEL series brings color into everyday life. Both light and robust. With these specifications we mainly focus on institutional catering such as; cafeterias, hospitals and nursery schools. Many people gather here every day. Different groups, departments and rooms sometimes make organizing tableware and cutlery difficult.

Our answer to this is the PIXEL cutlery model. The Pixel range includes table and dessert cutlery. The smaller cutlery size is ideal for daycare centers and schools.

## Unique selling points

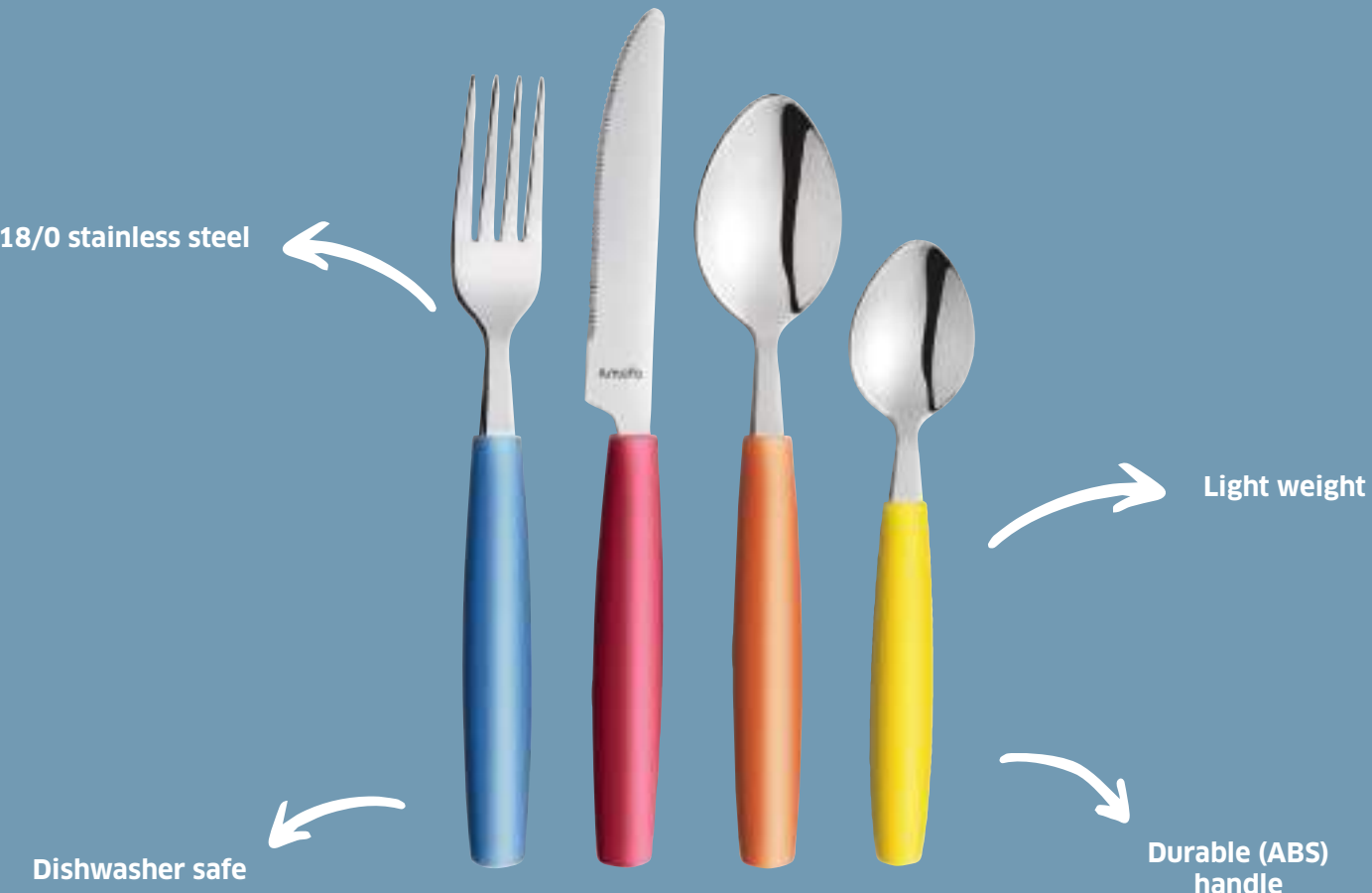

## Overview colors Pixel

- Blue Lagoon
- Cherry
- Mango
- Lemon









# 9036 HAVANE JUNGLE



**THICKNESS:**  
3,0 mm

**MATERIAL:**  
18/0

**FINISH:**  
mirror/hoogglans

	DESCRIPTION	CODE	LENGTH MM	BARCODE 354669
	Table knife / tafelmes	305	245	4621918
	Table fork / tafelvork	320	209	4621949
	Table spoon / tafellepel	325	209	4621925
	Dessert knife / dessertmes	335	205	4620775
	Dessert fork / dessertvork	340	177	4620805
	Dessert spoon / dessertlepel	345	177	4621796
	Medium teaspoon / koffielepel	375	135	4621932
	Cake fork / gebakvork	390	136	4621871



# 2390 SCANDINAVE



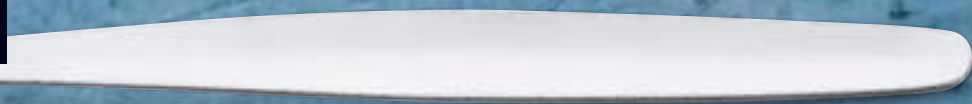





CUTLERY  
AMEFA 18/0



**THICKNESS:**  
1,8 mm

**MATERIAL:**  
18/0

**FINISH:**  
mirror/hoogglans

	DESCRIPTION	CODE	LENGTH MM	BARCODE 871115
	Table knife / tafelmes	305	216	5029557
	Table fork / tafelvork	320	201	5029571
	Table spoon / tafellepel	325	204	5029564
	Dessert knife / dessertmes	335	209	5016106
	Dessert fork / dessertvork	340	188	5016113
	Dessert spoon / dessertlepel	345	189	5016120
	Medium teaspoon / koffielepel	375	134	5016090
	Mocca spoon / theelepel	380	115	5109822
	Cake fork / gebakvork	390	140	5030232
	200 Pcs set in cutlery tray	V13	N/A	5341406















# 3319 FELICITY



**THICKNESS:**  
2,5 mm

**MATERIAL:**  
18/0

**FINISH:**  
mirror/hoogglans hammered

	DESCRIPTION	CODE	LENGTH MM	BARCODE 871115
	Table knife / tafelmes	305	225	5471554
	Table fork / tafelvork	320	199	5471585
	Table spoon / tafellepel	325	198	5471615
	Dessert knife / dessertmes	335	211	5471646
	Dessert fork / dessertvork	340	190	5471677
	Dessert spoon / dessertlepel	345	187	5471707
	Round soup spoon / dessertlepel ronde bak	350	187	5471738
	Fruit/cocktail knife / fruit-/cocktailmesje	360	170	5471769
	Medium teaspoon / koffielepel	375	133	5471790
	Large tea spoon/ koffielepel groot/cocktaillepel	378	165	5471820
	Mocca spoon / theelepel	380	107	5471851
	Cake fork / gebakvork	390	155	5471882
	Iced teaspoon / sorbetlepel	400	203	5471912



# 3319

## FELICITY BLACK



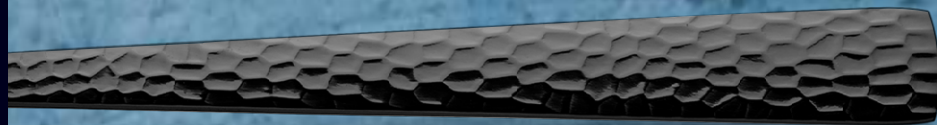



CUTLERY  
AMEFA 18/0



**THICKNESS:**  
2,5 mm

**MATERIAL:**  
18/0

**FINISH:**  
mirror/hoogglans hammered/PVD

	DESCRIPTION	CODE	LENGTH MM	BARCODE 871115
	Table knife / tafelmes	305	225	5493587
	Table fork / tafelvork	320	199	5493617
	Table spoon / tafellepel	325	198	5493648
	Medium teaspoon / koffielepel	375	133	5493679
	Mocca Spoon / moccapel	380	108	5493709
	Cake fork / gebakvork	390	156	5493730

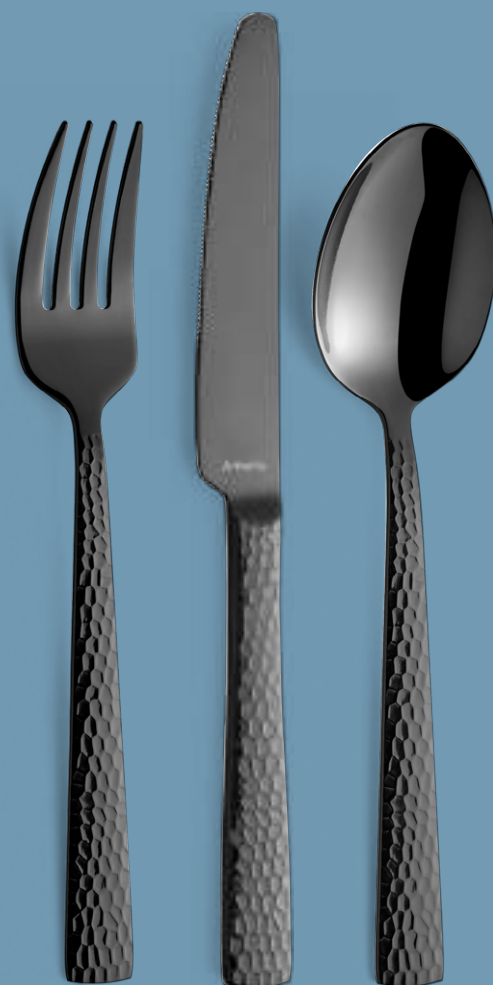

# 3319 FELICITY CHAMPAGNE



**THICKNESS:**  
2,5 mm

**MATERIAL:**  
18/0

**FINISH:**  
mirror/hoogglans hammered/PVD

	DESCRIPTION	CODE	LENGTH MM	BARCODE 871115
	Table knife / tafelmes	305	225	5493761
	Table fork / tafelvork	320	199	5493792
	Table spoon / tafellepel	325	198	5493822
	Medium teaspoon / koffielepel	375	133	5493853
	Mocca Spoon / moccaplepel	380	108	5493884
	Cake fork / gebakvork	390	156	5493914



# 3319

## FELICITY ROSE CHAMPAGNE







CUTLERY  
AMEFA 18/0



**THICKNESS:**  
2,5 mm

**MATERIAL:**  
18/0

**FINISH:**  
mirror/hoogglans hammered/PVD

	DESCRIPTION	CODE	LENGTH MM	BARCODE 871115
	Table knife / tafelmes	305	225	5502708
	Table fork / tafelvork	320	199	5502739
	Table spoon / tafellepel	325	198	5502760
	Medium teaspoon / koffielepel	375	133	5502791
	Mocca Spoon / moccapel	380	108	5502821
	Cake fork / gebakvork	390	156	5502852



# Felicity

**Felicity** brings the feeling of craftsmanship to the table through the coarse, imperfect decoration on the handle. The combination with a high-gloss finish gives a stylish and modern twist to any table setting. The hammered finish on the handle gives a nice reflection on the cutlery, which shows the shine perfectly.

## Unique selling points

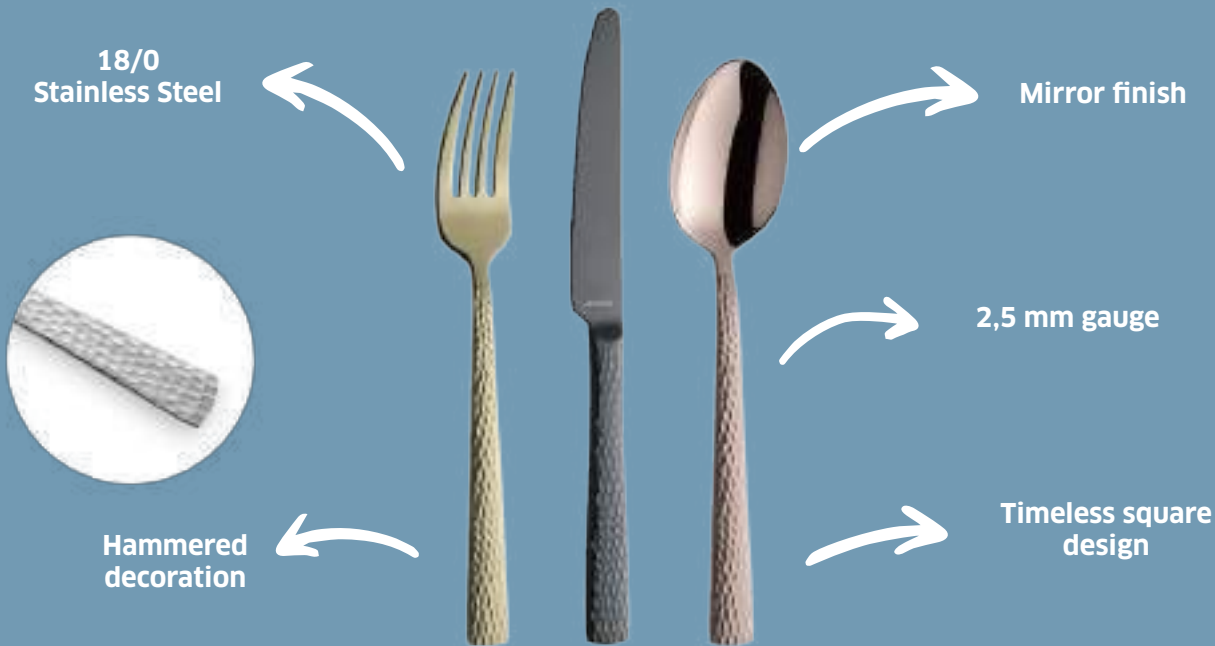

## Overview colours Felicity



# 2374 AMSTERDAM

















CUTLERY  
AMEFA 18/0



**THICKNESS:**  
2,2 mm

**MATERIAL:**  
18/0

**FINISH:**  
satin/matt

	DESCRIPTION	CODE	LENGTH MM	BARCODE 871115
	Table knife / tafelmes	305	203	5004363
	Table fork / tafelvork	320	192	5010135
	Table spoon / tafellepel	325	192	5010142
	Dessert knife / dessertmes	335	194	5010159
	Dessert fork / dessertvork	340	174	5010166
	Dessert spoon / dessertlepel	345	173	5010173
	Fruit/cocktail knife / fruit-/cocktailmesje	360	193	5030454
	Medium teaspoon / koffielepel	375	138	5010234
	Large tea spoon/ koffielepel groot/cocktaillepel	378	158	5010180
	Mocca spoon / theelepel	380	128	5010302
	Cake fork / gebakvork	390	146	5010203
	Iced teaspoon / sorbetlepel	400	187	5010210
	Gravy ladle / sauslepel	430	190	5007364
	Vegetable spoon / groentelepel	435	214	5007371
	Potato spoon / aardappellepel	440	204	5007388
	Cake server / gebakschep	455	223	5029328
	Butter spreader / botermesje	470	161	5010272







# SPECIALTIES

# 3010 INTEGRALE



SPECIALTIES

**THICKNESS:**  
2,5 mm

**MATERIAL:**  
18-10

**FINISH:**  
mirror/hoogglans

DESCRIPTION	CODE	LENGTH MM	BARCODE 871115
 Table knife / tafelmes	305	165	5398653
 Table fork / tafelvork	320	144	5398684
 Table spoon / tafellepel	325	148	5398714



# 3000 SELECT

SPECIALTIES

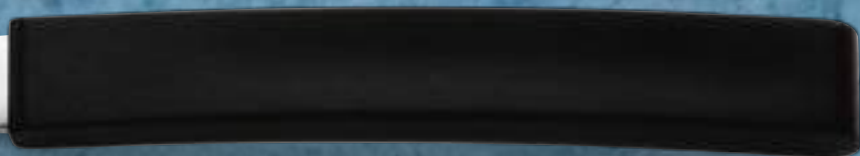

**THICKNESS:**  
2,5 mm

**MATERIAL:**  
18-10

**FINISH:**  
mirror/hoogglans

	DESCRIPTION	CODE	LENGTH MM	BARCODE 871115
	Table knife / tafelmes	335	192	5038054
	Table fork / tafelvork	340	180	5038078
	Table spoon / tafellepel	345	180	5038061







# 3001 SELECT



**THICKNESS:**  
2,5 mm

**MATERIAL:**  
18-10

**FINISH:**  
mirror/hoogglans

	DESCRIPTION	CODE	LENGTH MM	BARCODE 871115
	Knife special shape / mes speciaal	481	133	5038030
	Fork righthanded / rechtshandige vork	485	184	5055440
	Fork lefthanded / linkshandige vork	486	184	5038085
	Spoon righthanded / rechtshandige lepel	490	184	5038092
	Spoon lefthanded / linkshandige lepel	491	184	5038023



# SUSTAINABLE CUTLERY

SUSTAINABLE  
CUTLERY



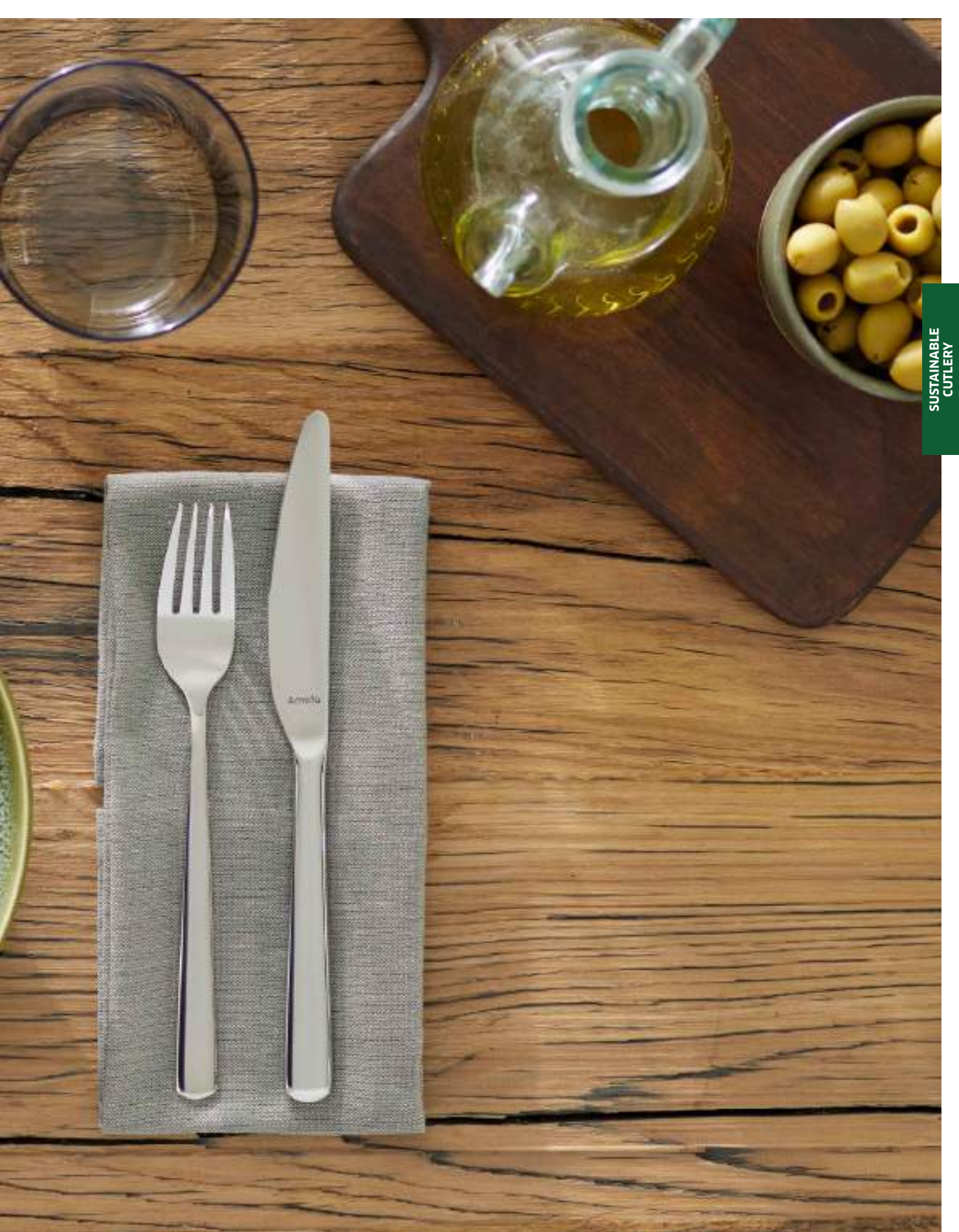

# 0295 SLIM







SUSTAINABLE  
CUTLERY

**THICKNESS:**  
0,6 mm

**MATERIAL:**  
18/0

**FINISH:**  
mirror/hoogglans

	DESCRIPTION	CODE	LENGTH MM	BARCODE 871115
	Knife / mes	AA7	188	9248097
	Fork / vork	AF7	178	9248103
	Spoon / lepel	AC7	168	9248110
	Small Spoon / Kleine lepel	AH7	112	9248127
	Small Fork / Kleine vork	AN7	120	9248134

All items are stackable



The SLIM cutlery is reusable and recyclable and helps to reduce the use of disposable cutlery. The set is optimized in size, thickness and weight, making it stackable whilst remaining a strong cutlery set.

# 0259 LEAVES



**THICKNESS:**  
0,5 mm

**MATERIAL:**  
18/0

**FINISH:**  
mirror/hoogglans

SUSTAINABLE  
CUTLERY

	DESCRIPTION	CODE	LENGTH MM	BARCODE 871115
	Table knife / tafelmes	BA1	165	5479413
	Table fork / tafelvork	BF1	165	5479451
	Table spoon / tafellepel	BC1	165	5479437
	Medium teaspoon / koffielepel	BH1	125	5484912

All items are stackable



# 2301 PHOENIX











SUSTAINABLE  
CUTLERY

**THICKNESS:**  
2,5 mm

**MATERIAL:**  
18/0

**FINISH:**  
mirror/hoogglans

DESCRIPTION	CODE	LENGTH MM	BARCODE 871115
 Table Knife / tafelmes	305	225	5502319
 Table Fork / tafelvork	320	194	5502340
 Table Spoon / tafellepel	325	198	5502371
 Dessert Knife / dessertmes	335	202	5502401
 Dessert Fork / dessertvork	340	174	5502432
 Dessert Spoon / dessertlepel	345	178	5502463
 Medium Teaspoon / koffielepel	375	132	5502494
 Mocca Spoon / theelepel	380	120	5502883
 Cake Fork / gebakvork	390	138	5502524



# Phoenix

Cutlery specialist AMEFA presents **Phoenix**: this new cutlery model is made of a minimum of 80% **recycled stainless steel**. The recycled material comes from post industrial waste and the remaining < 20% virgin stainless steel is needed to adhere to the EN norms as well as guarantee the food safety and an optimal quality. For the production of recycled stainless steel less energy is needed which is why by choosing recycled cutlery you contribute to reducing the ecological footprint, decreasing the amount of waste and thus to a cleaner planet.

## Unique selling points

High Quality 18/0  
Stainless Steel



> 80% Recycled  
stainless steel



Mirror finish

2,5 mm gauge

Food safe and  
Dishwasher safe

# **BUFFET & SERVING ARTICLES**





# 1319 BUFFET



BUFFET & SERVING  
ARTICLES

**THICKNESS:**  
3,5 mm

**MATERIAL:**  
18-10

**FINISH:**  
satin/mat

DESCRIPTION	CODE	LENGTH MM	BULK BARCODE 871115	HANGINGCARD BARCODE 871115
Soup Ladle / soeplepel	240	310	5018285	5035923
Large Gravy Ladle / sauslepel, groot	241	260	5018292	5035930
Dressing Spoon / dressinglepel	242	338	5018377	5035947
Slotted turner / visschep	243	310	5018315	5036043
Solid Serving Spoon / serveerlepel	244	310	5020004	5035954
Slotted Serving Spoon / schuimspaan	245	310	5018490	5035978
Meat Serving Fork / vlees-/serveervork	246	310	5018308	5036029
Cold Meat Fork / vleesvorkje	247	180	5018360	5036036
Large Salad Spoon / slalepel	248	290	5018346	5035985
Large Salad Fork / slavork, groot	249	290	5018353	5035992
Small Serving Spoon / opscheplepel	250	250	5018384	5035961
Small Salad Spoon / slalepel, klein	251	237	5018322	5036012
Small Salad Fork / slavork, klein	252	235	5018339	5036005
Serving Tongs / serveertang	253	290	5044697	5035442
Gravy Ladle / sauslepel	254	207	5006411	5048480
Cake/Pizza Server / gebakschep	255	260	5006466	5056348
Multi purpose tong / multifunctionele tang	256	310	5050605	N/A
Spaghetti spoon / spaghetti-serveerlepel	257	308	5060161	5056348
Small Serving Tongs / serveertang, klein	258	200	5073550	N/A
Snail tong / slakkentang	260	140	5072409	N/A



# 1319

## BUFFET



Soup ladle/  
soeplepel  
#240, 310 mm

Ladle/  
sauslepel groot  
#241, 260 mm

Dressing spoon/  
dressinglepel  
#242, 338 mm

Slotted turner/  
visschep  
#243, 310 mm

Solid serving  
spoon/ serveerlepel  
#244, 310 mm

Slotted spoon/  
geperforeerd  
#245, 310 mm

Meat serving fork/  
vleesdienvork  
#246, 310 mm



Cold meat fork/  
vleesvorkje  
#247, 180 mm

SSS large/  
slalepel groot  
#248, 290 mm

SSF large/  
slavork groot  
#249, 290 mm

Serving spoon/  
serveerlepel klein  
#250, 250 mm

SSS small/  
slalepel klein  
#251, 237 mm

SSF small/  
slavork klein  
#252, 235 mm

Serving tong/  
serveerklem groot  
#253, 290 mm



Gravy ladle/  
sauslepel  
#254, 207 mm

Cake server/  
gebakscjep  
#255, 260 mm

Multi purpose  
tong/ tang lang  
#256, 310 mm

Spaghetti spoon/  
lepel  
#257, 308 mm

Serv tong small/  
serveertang klein  
#258, 200 mm

Snail tong /  
slakkentang  
#260, 140 mm

# 1319

## BUFFET VELVET

**THICKNESS:**  
3,5 mm

**MATERIAL:**  
18-10

**FINISH:**  
velvet

DESCRIPTION	CODE	LENGTH MM	BULK BARCODE 871115	HANGINGCARD BARCODE 871115
Soup Ladle / soeplepel	240	310	5509110	5509714
Large Gravy Ladle / sauslepel, groot	241	260	5509141	5509745
Dressing Spoon / dressinglepel	242	338	5509172	5509776
Solid Serving Spoon / serveerlepel	244	310	5509202	5509837
Slotted Serving Spoon / schuimspaan	245	310	5509233	5509868
Meat Serving Fork / vlees-/serveervork	246	310	5509264	5509899
Cold Meat Fork / vleesvorkje	247	180	5509295	5509929
Large Salad Spoon / slalepel	248	290	5509325	5509950
Large Salad Fork / slavork, groot	249	290	5509356	5509981
Small Serving Spoon / opscheplepel	250	250	5509387	5510017
Small Salad Spoon / slalepel, klein	251	237	5509417	5510048
Small Salad Fork / slavork, klein	252	235	5509448	5510079
Serving Tongs / serveertang	253	290	5509479	5510109
Gravy Ladle / sauslepel	254	207	5509509	5510130
Cake/Pizza Server / gebaksclep	255	260	5509530	5510161
Multi purpose tong / multifunctionele tang	256	310	5509561	N/A
Small Serving Tongs / serveertang, klein	258	200	5509592	N/A
Snail tong / slakkentang	260	140	5509653	N/A



# 1319

## BUFFET BLACK



**THICKNESS:**  
3,5 mm

**MATERIAL:**  
18-10

**FINISH:**  
PVD

DESCRIPTION	CODE	LENGTH MM	BULK BARCODE 871115	HANGINGCARD BARCODE 871115
Soup Ladle / soeplepel	240	310	5447566	5447832
Large Gravy Ladle / sauslepel, groot	241	260	5447597	5447894
Dressing Spoon / dressinglepel	242	338	5448433	5448792
Solid Serving Spoon / serveerlepel	244	310	5447054	5447955
Slotted Serving Spoon / schuimspaan	245	310	5447115	5448013
Meat Serving Fork / vlees-/serveervork	246	310	5448495	5448853
Cold Meat Fork / vleesvorkje	247	180	5447627	5448075
Large Salad Spoon / slalepel	248	290	5447658	5448136
Large Salad Fork / slavork, groot	249	290	5447689	5448198
Small Serving Spoon / opscheplepel	250	250	5447719	5448259
Small Salad Spoon / slalepel, klein	251	237	5447740	5448310
Small Salad Fork / slavork, klein	252	235	5448556	5448914
Serving Tongs / serveertang	253	290	5447177	N/A
Gravy Ladle / sauslepel	254	207	5447238	5448976
Cake/Pizza Server / gebakscjep	255	260	5447771	5448372
Multi purpose tong / multifunctionele tang	256	310	5448617	N/A
Small Serving Tongs / serveertang, klein	258	200	5448679	N/A
Snail tong / slakkentang	260	140	5447290	N/A



# 1319 BUFFET COPPER



BUFFET & SERVING  
ARTICLES

**THICKNESS:**  
3,5 mm

**MATERIAL:**  
18-10

**FINISH:**  
PVD

DESCRIPTION	CODE	LENGTH MM	BULK BARCODE 871115	HANGINGCARD BARCODE 871115
Soup Ladle / soeplepel	240	310	5447320	5447801
Large Gravy Ladle / sauslepel, groot	241	260	5447351	5447863
Dressing Spoon / dressinglepel	242	338	5448402	5448761
Solid Serving Spoon / serveerlepel	244	310	5447023	5447924
Slotted Serving Spoon / schuimspaan	245	310	5447085	5447986
Meat Serving Fork / vlees-/serveervork	246	310	5448464	5448822
Cold Meat Fork / vleesvorkje	247	180	5447382	5448044
Large Salad Spoon / slalepel	248	290	5447412	5448105
Large Salad Fork / slavork, groot	249	290	5447443	5448167
Small Serving Spoon / opscheplepel	250	250	5447474	5448228
Small Salad Spoon / slalepel, klein	251	237	5447504	5448280
Small Salad Fork / slavork, klein	252	235	5448525	5448884
Serving Tongs / serveertang	253	290	5447146	N/A
Gravy Ladle / sauslepel	254	207	5447207	5448945
Cake/Pizza Server / gebakscjep	255	260	5447535	5448341
Multi purpose tong / multifunctionele tang	256	310	5448587	N/A
Small Serving Tongs / serveertang, klein	258	200	5448648	N/A
Snail tong / slakkentang	260	140	5447269	N/A





# 1319

## BUFFET STONEWASH

BUFFET & SERVING  
ARTICLES

**THICKNESS:**  
3,5 mm

**MATERIAL:**  
18-10

**FINISH:**  
stonewash

DESCRIPTION	CODE	LENGTH MM	BULK BARCODE 871115	HANGINGCARD BARCODE 871115
Soup Ladle / soeplepel	240	310	5464570	5465164
Large Gravy Ladle / sauslepel, groot	241	260	5464693	5465195
Solid Serving Spoon / serveerlepel	244	310	5464600	5465225
Slotted Serving Spoon / schuimspaan	245	310	5464723	5465256
Large Salad Spoon / slalepel	248	290	5464754	5465287
Large Salad Fork / slavork, groot	249	290	5464785	5465317
Small Serving Spoon / opscheplepel	250	250	5464815	5465348
Small Salad Spoon / slalepel, klein	251	237	5464846	5465379
Small Salad Fork / slavork, klein	252	235	5465102	5465409
Serving Tongs / serveertang	253	290	5465133	N/A
Cake/Pizza Server / gebakschep	255	260	5464631	5465430



# 1319 BUFFET GOLD



**THICKNESS:**  
3,5 mm

**MATERIAL:**  
18-10

**FINISH:**  
PVD

DESCRIPTION	CODE	LENGTH MM	BULK BARCODE 871115	HANGINGCARD BARCODE 871115
Soup Ladle / soeplepel	240	310	5497035	5504733
Large Gravy Ladle / sauslepel, groot	241	260	5500032	5505976
Dressing Spoon / dressinglepel	242	338	5500063	5506003
Solid Serving Spoon / serveerlepel	244	310	5497066	5506034
Slotted Serving Spoon / schuimspaan	245	310	5497097	5506065
Meat Serving Fork / vlees-/serveervork	246	310	5500094	5506096
Cold Meat Fork / vleesvorkje	247	180	5500124	5506126
Large Salad Spoon / slalepel	248	290	5500155	5506157
Large Salad Fork / slavork, groot	249	290	5500186	5506188
Small Serving Spoon / opscheplepel	250	250	5500216	5506218
Small Salad Spoon / slalepel, klein	251	237	5500247	5506249
Small Salad Fork / slavork, klein	252	235	5500278	5506270
Serving Tongs / serveertang	253	290	5500308	5506300
Gravy Ladle / sauslepel	254	207	5500339	5506331
Cake/Pizza Server / gebakscjep	255	260	5497127	5506362
Multi purpose tong / multifunctionele tang	256	310	5500360	N/A
Small Serving Tongs / serveertang, klein	258	200	5500391	N/A
Snail tong / slakkentang	260	140	5500452	N/A



# JUNTOS PERFECTLY SHARED

**This new specialty cutlery collection is perfect for elevating any shared dining experience, impressing guests with style and thoughtful detail.**

Designed with modern dining trends in mind, Amefa introduces a dedicated cutlery range for shared dining experiences, tapas, and charcuterie. This thoughtfully developed collection includes 10 unique items, each crafted for a specific function to elevate the presentation and enjoyment of small plates and shared appetizers. Whether it's for fine dining, catering, or casual settings, these pieces deliver both style and practicality.





# 0905 JUNTOS

SPECIALS

**THICKNESS:**  
2,0 mm

**MATERIAL:**  
18/0

**FINISH:**  
satin

DESCRIPTION	LENGTH MM	CODE	BULK BARCODE 871115	HANGINGCARD BARCODE 871115
Cocktail Knife / Cocktail Mes	190	360	5516248	5516187
Cocktail Fork / Cocktail Vork	175	365	5516330	5516217
Medium Spoon / Middelgrote Lepel	131	375	5516279	5516248
Slotted Spoon / Lepel Met Gaatjes	131	379	5516309	5516279
Small Spoon / Kleine Lepel	110	380	5516361	5516309
Small Three-prong Fork / Kleine Drietandige Vork	135	390	5516392	5516330
Long Spoon / Lange Lepel	190	400	5516422	5516361
Spreader / Smeermesje	160	470	5516453	5516392
Small Two-prong Fork / Kleine Tweetandige Vork	137	475	5516187	5516422
Spork / Spork	130	564	5516217	5516453



# Juntos

An elegant alternative to traditional cutlery. Designed to elevate the presentation of shared plates and small portions, this refined piece blends seamlessly into modern and traditional table settings. Crafted for everyday use, it is as durable as it is distinctive. Available in three timeless colours and fully dishwasher safe. Beauty meets practicality at every table.

## Unique selling points

High quality 18/0  
Stainless Steel



Decoration on  
handle



Satin finish



Elegant alternative to  
traditional cutlery



## Overview finishes Juntos



Stainless  
Steel



Black Satin  
PVD



Gold Satin  
PVD

# 0905 JUNTOS GOLD

SPECIALS

**THICKNESS:**  
2,0 mm

**MATERIAL:**  
18/0

**FINISH:**  
satin/gold PVD

DESCRIPTION	LENGTH MM	CODE	BULK BARCODE 871115	HANGINGCARD BARCODE 871115
Cocktail Knife / Cocktail Mes	190	360	5516842	5516781
Cocktail Fork / Cocktail Vork	175	365	5516934	5516811
Medium Spoon / Middelgrote Lepel	131	375	5516873	5516842
Slotted Spoon / Lepel Met Gaatjes	131	379	5516903	5516873
Small Spoon / Kleine Lepel	110	380	5516965	5516903
Small Three-prong Fork / Kleine Drietandige Vork	135	390	5516996	5516934
Long Spoon / Lange Lepel	190	400	5517023	5516965
Spreader / Smeermesje	160	470	5517054	5516996
Small Two-prong Fork / Kleine Tweetandige Vork	137	475	5516781	5517023
Spork / Spork	130	564	5516811	5517054



# 0905 JUNTOS BLACK



**THICKNESS:**  
2,0 mm

**MATERIAL:**  
18/0

**FINISH:**  
satin/black PVD

DESCRIPTION	LENGTH MM	CODE	BULK BARCODE 871115	HANGINGCARD BARCODE 871115
Cocktail Knife / Cocktail Mes	190	360	5516545	5516484
Cocktail Fork / Cocktail Vork	175	365	5516637	5516514
Medium Spoon / Middelgrote Lepel	131,5	375	5516576	5516545
Slotted Spoon / Lepel Met Gaatjes	131,5	379	5516606	5516576
Small Spoon / Kleine Lepel	110	380	5516668	5516606
Small Three-prong Fork / Kleine Drietandige Vork	134,8	390	5516699	5516637
Long Spoon / Lange Lepel	190	400	5516729	5516668
Spreader / Smeermesje	160	470	5516750	5516699
Small Two-prong Fork / Kleine Tweetandige Vork	137	475	5516484	5516729
Spork / Spork	129,5	564	5516514	5516750



# SPECIALS

MATERIAL	DESCRIPTION	CODE	LENGTH MM	BARCODE 871115
18/0	Spoon Rest / Lepelhouder	569	260	5464341
18-10	Solid Serving Spoon	444	450	5472704



This spoon rest is the perfect addition to the buffet collection. A spoon rest has the right size for laying down a spoon, brush or utensils while cooking or serving. It also helps to keep the counter clean.

# SPECIALS



**MATERIAL:**  
18-10

**FINISH:**  
mirror/hoogglans

DESCRIPTION	PATTERN NO.	CODE	LENGTH MM	BARCODE 871115
 Mocca Spoon / theelepel	0264	380	117	5118251
 Lobster fork / kreeftvork	1810	423	226	5099741
 Oyster fork / oestervorkje	1810	420	137	5038146
 Amuse spoon regular / amuselepel	1824	560	120	5060147



0264/380  
Mocca Spoon / theelepel



1824/560  
Amuse Spoon Large / amuselepel groot



1810/420  
Oyster Fork / oestervork



1810/423  
Lobster Fork / kreeftvork

# 0024 BEAR



SPECIALS

**THICKNESS:**  
2,0 mm

**MATERIAL:**  
18/0

**FINISH:**  
satin/mat

	DESCRIPTION	CODE	LENGTH MM	BARCODE 871115
	Children's knife / kindermes	540	171	5469766
	Children's fork / kindervork	545	141	5469797
	Children's spoon / kinderlepel	550	141	5469827



# 4310 TEDDY BEAR



**THICKNESS:**  
2,5 mm

**MATERIAL:**  
18-10

**FINISH:**  
mirror/hoogglans

SPECIALS

DESCRIPTION	CODE	LENGTH MM	BARCODE 871115
 Children's knife / kindermes	540	183	5065005
 Children's fork / kindervork	545	163	5065029
 Children's spoon / kinderlepel	550	168	5065012



# STEAK

STEAK,  
SALT&PEPPER



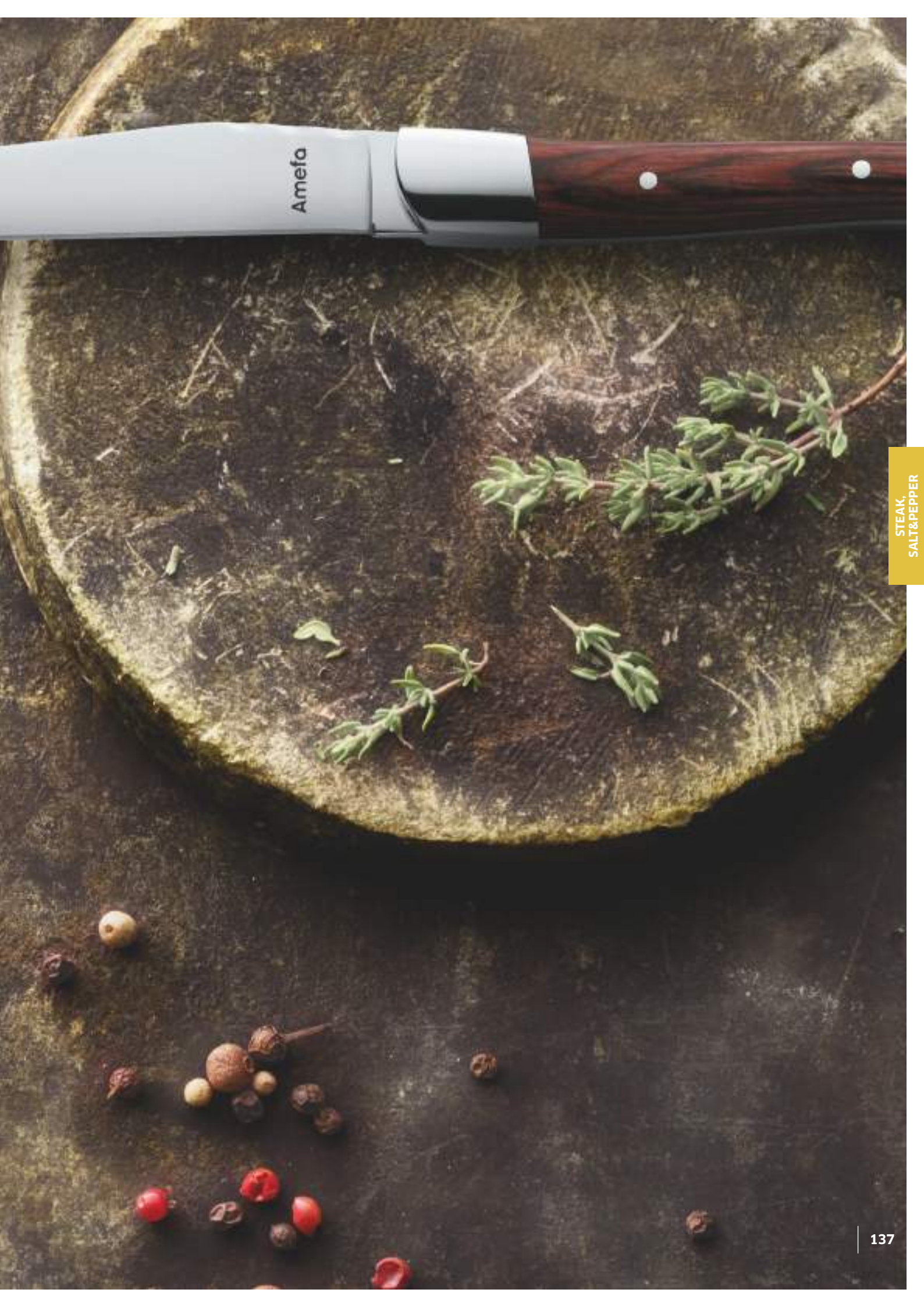

Amefa

STEAK,  
SALT&PEPPER

# 2520 ROYAL STEAK



**THICKNESS:**  
2,5 mm

**MATERIAL:**  
13/0

**FINISH:**  
mirror/hoogglans

STEAK,  
SALT&PEPPER

	DESCRIPTION	CODE	LENGTH MM	MATERIAL HANDLE	BARCODE 871115
	Steak knife brown serrated / steakmes bruin met kartel	113	230	Pakka	5331506
	Steak knife black serrated/ steakmes zwart met kartel	113	230	ABS	5496304
	Steak knife Lunar Hammered/ steakmes Lunar gehamerd	1630	230	Pakka	5494737
	Steak fork brown / steakvork bruin	320	227	Pakka	5408253



# 2465 BONGO HAMMERED



**THICKNESS:**  
2,5 mm

**MATERIAL:**  
13/0

**FINISH:**  
mirror/hoogglans hammered

DESCRIPTION	CODE	LENGTH MM	BARCODE
 Steak knife / steakmes	315	228	3546698700732
 3 Steak knives on blister / 3 Steakmessen op hangkaart	SK3	228	8711155478928



STEAK,  
SALT&PEPPER

# 2550 ACHILE



**THICKNESS:**  
2,0 mm

**MATERIAL:**  
13/0

**FINISH:**  
mirror/hoogglans

STEAK,  
SALT&PEPPER

DESCRIPTION	CODE	LENGTH MM	MATERIAL HANDLE	BARCODE 301415
 Steak knife/steakmes	113	230	Pakka	1000281





# 4917 HERCULE



**THICKNESS:**  
1,2 mm

**MATERIAL:**  
13/0

**FINISH:**  
mirror/hoogglans

DESCRIPTION	CODE	LENGTH MM	MATERIAL HANDLE	BARCODE
 Hercule XXL Steakknife micro serration / Steakmes fijne kartel	621	245	Pakka	3546693910006
 3 Hercule XXL Steakknives on blister / 3 Steakmessen op hangkaart	SK3	245	Pakka	8711155446415



STEAK,  
SALT&PEPPER

# 4918 FUSION



**THICKNESS:**  
2,0 mm

**MATERIAL:**  
Mov

**FINISH:**  
mirror/hoogglans

STEAK,  
SALT&PEPPER

DESCRIPTION	CODE	LENGTH MM	MATERIAL HANDLE	BARCODE
 Steak knife/ steakmes	122	220	ABS	3546699 420011



# 7038 CHULETERO



**THICKNESS:**  
2,5 mm

**MATERIAL:**  
18-10

**FINISH:**  
mirror/hoogglans

	DESCRIPTION	CODE	LENGTH MM	BARCODE 871115
	Steak knife/ steakmes	315	225	5057536
	Steak fork/ vork	371	202	5057543
	6 steak knives on blister / 6 steakmessen op hangkaart	BR6	225	5450962
	6 steak forks on blister / 6 steakvorken op hangkaart	BQ6	202	5460466



STEAK,  
SALT&PEPPER

# 7000 PIZZA



**THICKNESS:**  
2,0 mm

**MATERIAL:**  
18/0

**FINISH:**  
mirror/hoogglans

STEAK,  
SALT&PEPPER

	DESCRIPTION	CODE	LENGTH MM	MATERIAL HANDLE	BARCODE 871115
	Steak knife/ steakmes	315	210	POM	5029786
	Steak fork/ vork	340	201	POM	5029809
	Spoon/ lepel	345	196	POM	5029793
	6 steak/pizza knives on blister/ 6 steak/pizzamessen op hangkaart	BR6	210	POM	5455417
	6 steak/pizza forks on blister/ 6 steak/pizzavorken op hangkaart	AG6	201	POM	5455448
	6 spoons on blister / 6 lepels op hangkaart	AE6	196	POM	5455479



# 7000 PIZZA WOOD



**THICKNESS:**  
2,0 mm

**MATERIAL:**  
18/0

**FINISH:**  
mirror/hoogglans

	DESCRIPTION	CODE	LENGTH MM	MATERIAL HANDLE	BARCODE 871115
	Steak knife wood/ steakmes hout	620	210	Pakka	5436232
	Steak fork wood/ vork hout	340	201	Pakka	5436263
	6 steak knives wood on blister/ 6 steakmessen hout op hangkaart	RB6	210	Pakka	5436294
	6 steak forks wood on blister / 6 steakvorken hout op hangkaart	AG6	201	Pakka	5442158

STEAK,  
SALT&PEPPER



# 7025 STEAK



**THICKNESS:**  
1.2 mm

**MATERIAL:**  
13/0

**FINISH:**  
satin/mat

STEAK,  
SALT&PEPPER

	DESCRIPTION	CODE	LENGTH MM	MATERIAL HANDLE	BARCODE 871115
	Steak knife micro serration/ steakmes fijne kartel	620	217	POM	5423928
	6 steak/pizza knives on blister/ 6 steak/pizzamessen op hangkaart	RB6	217	POM	5442585



# 7060 TENDER LOIN

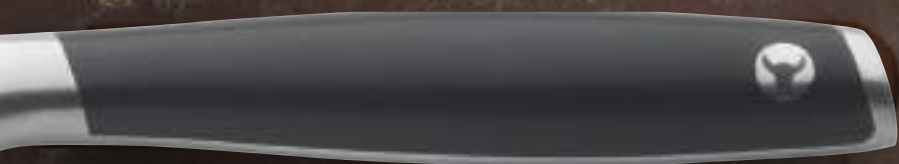

**THICKNESS:**  
2,0 mm

**MATERIAL:**  
13/0

**FINISH:**  
mirror/hoogglans

DESCRIPTION	CODE	LENGTH MM	MATERIAL HANDLE	BARCODE 402761
 Steak knife/ steakmes	315	247	ABS	5683158



STEAK,  
SALT&PEPPER

# 6765 SALT&PEPPER MODERN



**GRINDER:**  
ceramic

**MATERIAL:**  
rubber wood

**FINISH:**  
wood/hout

## DESCRIPTION

DESCRIPTION	CODE	LENGTH CM	BARCODE 871115
Salt&Pepper mills wood set of 2 / Zout&Pepermolen hout set van 2	PS2	15	5456889
Salt&Pepper mill XL wood / Zout&Pepermolen XL hout	959	30	5456902



# 6765 SALT&PEPPER MODERN



**GRINDER:**  
ceramic

**MATERIAL:**  
rubber wood

**FINISH:**  
mirror/hoogglans+mat

## DESCRIPTION

Salt&Pepper mills black set of 2 /  
Zout&Pepermolen zwart set van 2

CODE	LENGTH CM	BARCODE 871115
PS2	15	5468455

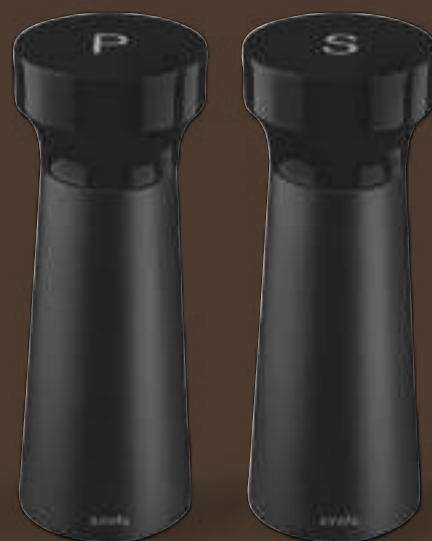

STEAK,  
SALT&PEPPER

# 6755 SALT&PEPPER CLASSIC



**GRINDER:**  
ceramic

**MATERIAL:**  
rubber wood

**FINISH:**  
wood/hout

## DESCRIPTION

DESCRIPTION	CODE	LENGTH CM	BARCODE 871115
1 piece Pepper&Salt mill Wood 26 cm - in gift box	959	26	5468868
2 piece Pepper&Salt mills set Wood 15 cm - in gift box	PS2	15	5479598

## Topview

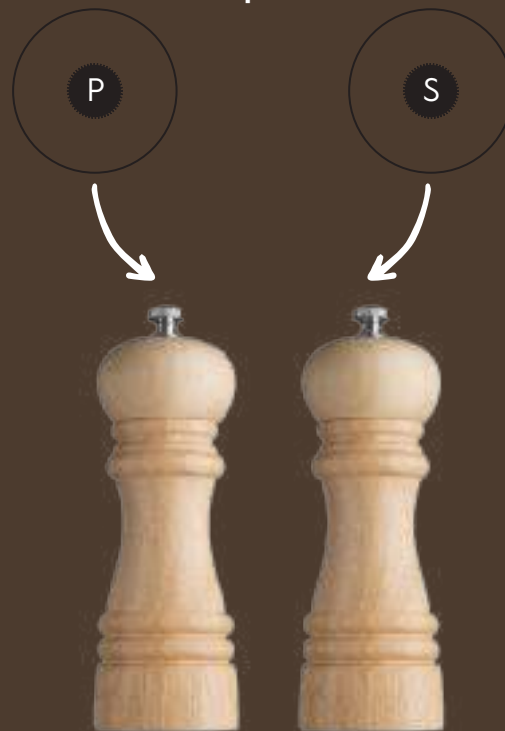

# 6765 SALT&PEPPER CLASSIC



**GRINDER:**  
ceramic

**MATERIAL:**  
rubber wood

**FINISH:**  
mirror/hoogglans+mat

DESCRIPTION	CODE	LENGTH CM	BARCODE 871115
1 piece Pepper&Salt mill Black 26 cm - in gift box	959	26	5468899
2 piece Pepper&Salt mills set Black 15 cm - in gift box	PS2	15	5479574

Topview

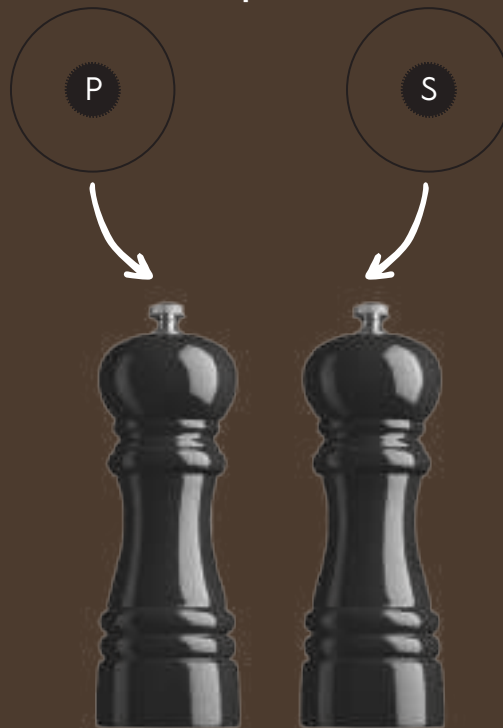

STEAK,  
SALT&PEPPER

# CASH AND CARRY



Amefa

# CASH & CARRY BOXES AMEFA PREMIERE

DESCRIPTION	CODE	METROPOLE 1170	METROPOLE BLACK 1170	METROPOLE GOLD 1170	METROPOLE CHAMPAGNE 1170	METROPOLE VELVET 1170
		BARCODE 871115				
6 table knives / 6 tafelmessen	BKCCAA6		5490081	5490166	5490241	5510192
12 table knives / 12 tafelmessen	BKCCAA7	5489863				
6 dessert knives / 6 dessertmessen	BKCCAB6					5510314
12 dessert knives / 12 dessertmessen	BKCCAB7	5489887				
6 table spoons / 6 tafellepels	BKCCAC6		5490104	5490180	5490265	5510215
12 table spoons / 12 tafellepels	BKCCAC7	5489900				
6 dessert spoons / dessertlepels	BKCCAE6					5510338
12 dessert spoons / 12 dessertlepels	BKCCAE7	5489924				
6 table forks / 6 tafelvorken	BKCCAF6		5490128	5490203	5490289	5510239
12 table forks / 12 tafelvorken	BKCCAF7	5489948				
6 dessert forks / 6 dessertvorken	BKCCAG6					5510352
12 dessert forks / 12 dessertvorken	BKCCAG7	5489962				
6 medium teaspoons / 6 koffielepels	BKCCAH6		5490142	5490227	5490302	5510253
12 medium teaspoons / 12 koffielepels	BKCCAH7	5489986				
6 mocca spoons / 6 theelepels	BKCCAK6					5510277
12 mocca spoons / 12 theelepels	BKCCAK7	5490005				
6 cake forks / 6 gebakvorkjes	BKCCAN6					5510291
12 cake forks / 12 gebakvorkjes	BKCCAN7	5490029				
12 fruit knives / 12 fruit-/cocktailmesjes	BKCCAU7					
6 iced teaspoons / 6 sorbetlepels	BKCCAV6					5510376
12 iced teaspoons / 12 sorbetlepels	BKCCAV7	5490043				
6 butter spreaders / 6 botermesjes	BKCCBB6	5490067				

## DRIFT 8050

DESCRIPTION	CODE	BARCODE
		871115
12 table knives / 12 tafelmessen	BKCCAA7	5492849
12 dessert knives / 12 dessertmessen	BKCCAB7	5492863
12 table spoons / 12 tafellepels	BKCCAC7	5492887
12 dessert spoons / 12 dessertlepels	BKCCAE7	5492900
12 table forks / 12 tafelvorken	BKCCAF7	5492924
12 dessert forks / 12 dessertvorken	BKCCAG7	5492948
12 medium teaspoons / 12 koffielepels	BKCCAH7	5492962
12 mocca spoons / 12 theelepels	BKCCAK7	5492986
12 cake forks / 12 gebakvorkjes	BKCCAN7	5493006
12 fish knives / 12 vismessen	BKCCAQ7	
12 fish forks / 12 visvorken	BKCCAR7	
12 iced teaspoons / 12 sorbetlepels	BKCCAV7	



DESCRIPTION	CODE	OXFORD	OXFORD	OXFORD	OXFORD	ROYAL STEAK	
		1860	BLACK 1860	GOLD 1860	CHAMPAGNE 1860	2520	
		BARCODE 871115					
6 table knives / 6 tafelmessen	BKCCAA6		5491569	5491644	5491729		
12 table knives / 12 tafelmessen	BKCCAA7	5491323					
12 dessert knives / 12 dessertmessen	BKCCAB7	5491347					
6 table spoons / 6 tafellepels	BKCCAC6		5491583	5491668	5491743		
12 table spoons / 12 tafellepels	BKCCAC7	5491361					
12 dessert spoons / 12 dessertlepels	BKCCAE7	5491385					
6 table forks / 6 tafelvorken	BKCCAF6		5491606	5491682	5491767		
12 table forks / 12 tafelvorken	BKCCAF7	5491408					
12 dessert forks / 12 dessertvorken	BKCCAG7	5491422					
6 medium teaspoons / 6 koffielepels	BKCCAH6		5491620	5491705	5491781		
12 medium teaspoons / 12 koffielepels	BKCCAH7	5491446					
12 mocca spoons / 12 theelepels	BKCCAK7	5491460					
12 cake forks / 12 gebakvorkjes	BKCCAN7	5491484					
12 fish knives / 12 vismessen	BKCCAQ7	5491507					
12 fish forks / 12 visvorken	BKCCAR7	5491521					
12 iced teaspoons / 12 sorbetlepels	BKCCAV7	5491545					
6 steak knives wood / 6 steakmessen hout	BKCCAF6					5492382	
6 steak knives black / 6 steakmessen zwart	BKCCAF6					5492405	
6 steak knives green/brown / 6 steakmessen groen/bruin	BKCCDR6					5501978	



CASH & CARRY

# CASH & CARRY BOXES AMEFA

DESCRIPTION	CODE	FILET	AUSTIN	AUSTIN	AUSTIN	AUSTIN	FELICITY
		0900	1410	STONEWASH 1410	GOLD 1410	BLACK 1410	3319
		BARCODE 871115					
12 table knives / 12 tafelmessen	BKCCAA7	5489481	5490326	5490548	5490814	5490739	5492429
12 dessert knives / 12 dessertmessen	BKCCAB7	5489504	5490340	5490562			
12 table spoons / 12 tafellepels	BKCCAC7	5489528	5490364	5490586	5490838	5490753	5492443
12 dessert spoons / 12 dessertlepels	BKCCAE7	5489542	5490388	5490609			
12 table forks / 12 tafelvorken	BKCCAF7	5489566	5490401	5490623	5490852	5490777	5492467
12 dessert forks / 12 dessertvorken	BKCCAG7	5489580	5490425	5490647			
12 medium teaspoons / 12 koffielepels	BKCCAH7	5489603	5490449	5490661	5490876	5490791	5492481
12 mocca spoons / 12 theelepels	BKCCAK7	5489627	5490463	5490685			5492504
36 mocca spoons / 36 theelepels	BKCCAK9	5489641					
12 cake forks / 12 gebakvorkjes	BKCCAN7	5489665	5490487	5490692			5492528
12 fish knives / 12 vismessen	BKCCAQ7						
12 cocktail spoons / 12 cocktaillepels	BKCCAS7	5489689					
12 cocktail forks / 12 cocktailvorkjes	BKCCAT7	5489702					
12 fruit knives / 12 fruit-/cocktailmesjes	BKCCAU7	5489726					
12 iced teaspoons / 12 sorbetlepels	BKCCAV7	5489740	5490500	5490715			5492542
12 ice-cream spoons / 12 ijsschepjes	BKCCAW7						
2 gravy ladles / 2 sauslepels	BKCCAY2	5489764					
2 vegetable spoons / 2 groentelepels	BKCCAZ2	5489788					
2 potato spoons / 2 aardappellepels	BKCCBA2	5489801					
6 butter spreaders / 6 botermesjes	BKCCBB6	5489825	5493167				
2 cake servers / 2 gebakscheppen	BKCCBC2						
12 liquor spoons / 12 likeurlepels	BKCCBK7	5489849					
12 small cake forks / 12 gebakvorkjes klein	BKCCBH7						
12 oyster forks / 12 oestervorkjes	BKCCBF7						
6 lobster forks / 6 kreeftvorkjes	BKCCCB6						
6 steak forks / 6 steakvorken	BKCCBQ7						
6 steak knives / 6 steakmessen	BKCCBR7						



		FLORENCE 1810	BLISS 1933	AMSTERDAM 2374	CHULETERO 7038	ELEGANCE 7204	BAGUETTE 8440	
DESCRIPTION	CODE	BARCODE 871115						
12 table knives / 12 tafelmessen	BKCCAA7	5490906	5491804	5492009		5492566	5493020	
12 dessert knives / 12 dessertmessen	BKCCAB7	5490920	5491828	5492023		5492580	5493044	
12 table spoons / 12 tafellepels	BKCCAC7	5490944	5491842	5492047		5492603	5493068	
12 dessert spoons / 12 dessertlepels	BKCCAE7	5490968	5491866	5492061		5492627	5493082	
12 table forks / 12 tafelvorken	BKCCAF7	5490982	5491880	5492085		5492641	5493105	
12 dessert forks / 12 dessertvorken	BKCCAG7	5491002	5491903	5492108		5492665	5493129	
12 medium teaspoons / 12 koffielepels	BKCCAH7	5491026	5491927	5492122		5492689	5493143	
12 mocca spoons / 12 theelepels	BKCCAK7	5491040	5491941	5492146		5492702	5497363	
36 mocca spoons / 36 theelepels	BKCCAK9			5492160				
12 cake forks / 12 gebakvorkjes	BKCCAN7	5491064	5491965	5492184		5492726	5497387	
12 cocktail spoons / 12 cocktaillepels	BKCCAS7	5491088		5492221		5492740		
12 cocktail forks / 12 cocktailvorkjes	BKCCAT7	5491101				5492764		
12 fruit knives / 12 fruit-/cocktailmesjes	BKCCAU7	5491125		5492245		5492788		
12 iced teaspoons / 12 sorbetlepels	BKCCAV7	5491149	5491989	5492269		5492801		
12 ice-cream spoons / 12 ijsschepjes	BKCCAW7	5491163						
2 gravy ladles / 2 sauslepels	BKCCAY2			5492283				
2 vegetable spoons / 2 groentelepels	BKCCAZ2			5492306				
2 potato spoons / 2 aardappellepels	BKCCBA2	5491187		5492320				
6 butter spreaders / 6 botermesjes	BKCCBB6	5491200		5492344		5492825		
2 cake servers / 2 gebakscheppen	BKCCBC2	5491224		5492368				
12 liquor spoons / 12 likeurlepels	BKCCBK7	5491286						
12 small cake forks / 12 gebakvorkjes klein	BKCCBH7	5491262						
12 oyster forks / 12 oestervorkjes	BKCCBF7	5491248						
6 lobster forks / 6 kreeftvorkjes	BKCCCB6	5491309						
12 steak forks/ 12 steakvorken	BKCCBQ7				5460466			
12 steak knives / 12 steakmessen	BKCCBR7				5450962			

		SOPRANO 1114	SOPRANO COPPER 1114	SOPRANO VELVET 1114	SOPRANO BLACK/GOLD 1114	PHOENIX 2301
DESCRIPTION	CODE	BARCODE 871115				
6 table knives / 6 tafelmessen	BKCCAA6		5504979	5505372	5505174	
12 table knives / 12 tafelmessen	BKCCAA7	5505570				5505778
6 dessert knives / 6 dessertmessen	BKCCAB6		5504993	5505396	5505198	
12 dessert knives / 12 dessertmessen	BKCCAB7	5505594				5505792
6 table spoons / tafellepels	BKCCAC6		5505013	5505419	5505211	
12 table spoons / 12 tafellepels	BKCCAC7	5505617				5505815
6 dessert spoons / dessertlepels	BKCCAE6		5505037	5505433	5505235	
12 dessert spoons / 12 dessertlepels	BKCCAE7	5505631				5505839
6 table forks / 6 tafelvorken	BKCCAF6		5505051	5505457	5505259	
12 table forks / 12 tafelvorken	BKCCAF7	5505655				5505853
6 dessert forks / 6 dessertvorken	BKCCAG6		5505075	5505471	5505273	
12 dessert forks / 12 dessertvorken	BKCCAG7	5505679				5505877
6 medium teaspoons / 6 koffielepels	BKCCAH6		5505099	5505495	5505297	
12 medium teaspoons / 12 koffielepels	BKCCAH7	5505693				5505891
6 mocca spoons / 6 theelepels	BKCCAK6		5505112	5505518	5505310	
12 mocca spoons / 12 theelepels	BKCCAK7	5505716				5505914
6 cake forks / 6 gebakvorkjes	BKCCAN6		5505136	5505532	5505334	
12 cake forks / 12 gebakvorkjes	BKCCAN7	5505730				5505938
6 iced teaspoons / 6 sorbetlepels	BKCCAV6		5505150	5505556	5505358	
12 iced teaspoons / 12 sorbetlepels	BKCCAV7	5505754				



# 0265 ECO



**THICKNESS:**  
1,0 mm

**MATERIAL:**  
18/0

**FINISH:**  
mirror/hoogglans

DESCRIPTION	CODE	BARCODE 871115
 mocca spoon / theelepel	B000380	5018629
 120 mocca spoons/ 120 theelepels	T000AL8	5004615

CASH &  
CARRY





# 2374 AMSTERDAM



**THICKNESS:**  
2,2 mm

**MATERIAL:**  
18/0

**FINISH:**  
mirror/hoogglans

	DESCRIPTION	CODE	BARCODE 871115
	60 medium teaspoons/ 60 koffielepels	T000AJ8	5104391
	60 cake forks/ 60 gebakvorkjes	T000AP5	5104407

CASH &  
CARRY



# R400

## KITCHEN ESSENTIALS

**MATERIAL:**

MoV steel / MoV staal (5Cr15MoV)

**FINISH:**

satin / mat

**DESCRIPTION**

DESCRIPTION	CODE	BARCODE 871115
2 x All purpose knife grey / 2 x huishoudmes grijs	UK1	5409465
Peeling knife & Peeler / schilmesje & gebogen schilmesje	PE2	5409588
3 pc Starter set / 3 delige starterset	Z79	5409526
3 pc Starter set / 3 delige starterset	Z80	5409557
2 x Tomato knife / 2 x tomatenmes	RS2	5409403
2 x Paring knives / 2 x schilmesje	PK2	5409496



# R400 KITCHEN ESSENTIALS



2x All purpose knife grey /  
2x huishoudmes grijs  
R400GYP446UK1



Peeling knife & Peeler /  
schilmesje & gebogen schilmesje  
R400MZP448PE2



3 pc Starter set /  
3 delige starterset  
R400MZP449Z79



3 pc Starter set /  
3 delige starterset  
R400MZP450Z80



2x Tomato knife /  
2 x tomatenmes  
R400RDP444RS2



2x Paring knives /  
2x schilmesje  
R400RDP447PK2

## SABATIER TROMPETTE®

Since 1874, Sabatier Trompette has built a reputation for outstanding cutting performance. The brand guarantees high levels of manufacturing standards throughout the manufacturing process combined of both traditional and modern technology know-how.

Focusing on form and function, we use highly sophisticated materials to produce extremely reliable and functional knives for both professional and amateur chefs.





KITCHEN KNIVES

# TECHNICAL SPECIFICATIONS

All the SABATIER TROMPETTE blades are made of a high-quality steel perfectly adapted to a professional and intensive use. The molybdenum vanadium (MOV) increases the hardness and the flexibility of the blade to keep optimum cutting performances through the time. MOV is also easier to sharp.



The rounded back of blades guarantees a better comfort of use.

BACK OF BLADE  
ROUNDED

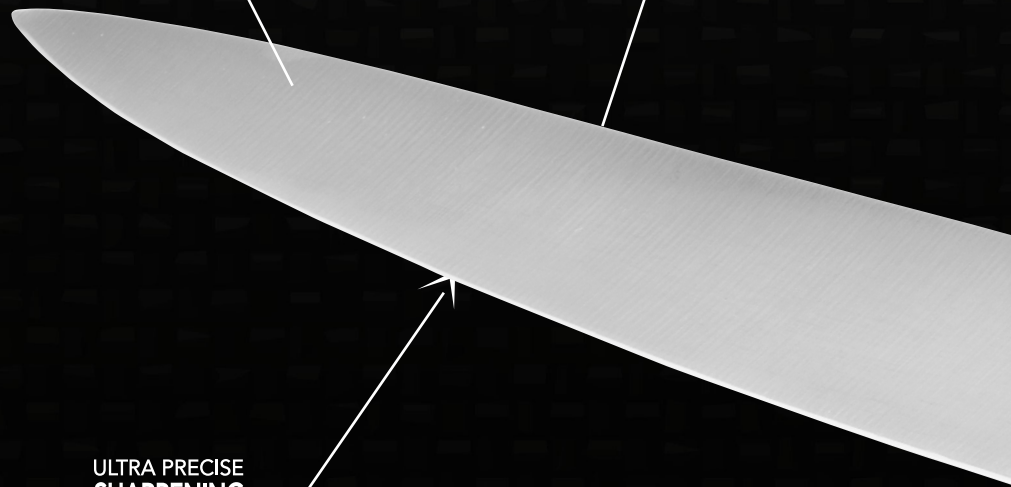

ULTRA PRECISE  
SHARPENING



The cutting edge of the SABATIER TROMPETTE blades fits all the professional requirements.

At the very end of the production process, the SABATIER TROMPETTE knives benefit from a manual leather polishing of the blade edges. This careful operation enhances the cutting performances and guarantees an excellent finishing.

## Hanging cards

Vulcano    Origin    Asean    Pro Tech



Pegboardable pack

6 languages

Transparent cover  
+ printed card

Blade protection

Secured support



# 8657 VULCANO

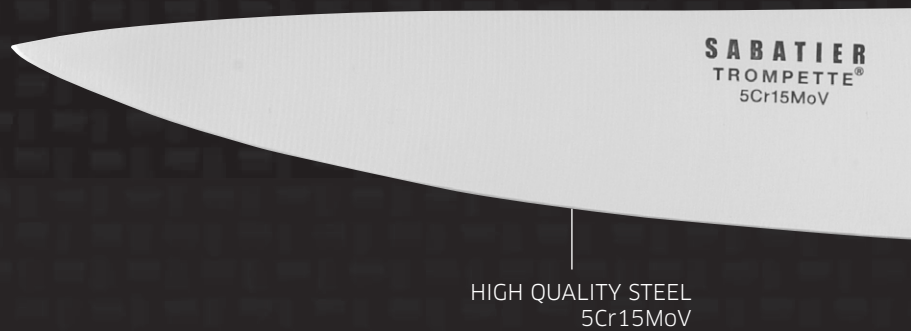

DESCRIPTION	CODE	BLADE LENGTH MM	BARCODE 354669
1 Paring knife / schilmes	117	90	9181011
2 Boning knife / uitbeenmes	227	130	9181028
3 Flexible filet knife / fileermes	142	180	9181042
4 Santoku knife / santoku mes	161	175	9181059
5 Bread knife / broodmes	191	200	9181066
6 Chef knife / koksmes	129	160	9181035
7 Chef knife / koksmes	132	200	9181073



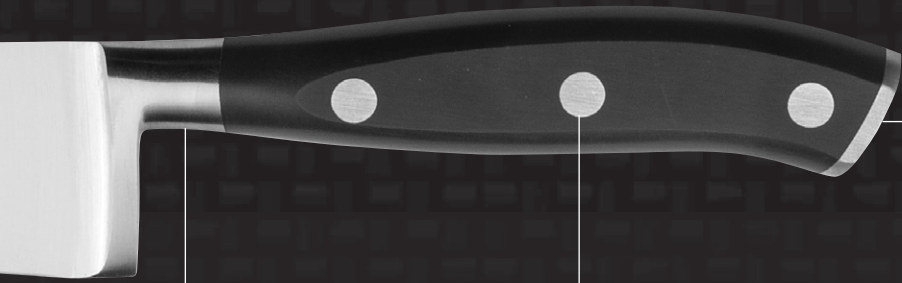

STAINLESS STEEL BOLSTER

FULL TANG HANDLE / POM + STAINLESS STEEL RIVETS

STAINLESS STEEL BASE



3



4



5



6



7

KITCHEN KNIVES

# 8701 ASEAN



HIGH QUALITY STEEL  
5Cr15MoV

DESCRIPTION	CODE	BLADE LENGTH MM	BARCODE 354669
1 Paring knife / schilmes	117	90	9211015
2 Utility knife / huishoudmes	116	125	9211022
3 Flexible Sole knife / fileermes	142	180	9211060
4 Santoku knife / santoku mes	161	175	9211039
5 Carving knife / vleesmes	012	200	9211046
6 Chef knife / koksmes	132	200	9211053

KITCHEN KNIVES



1

2

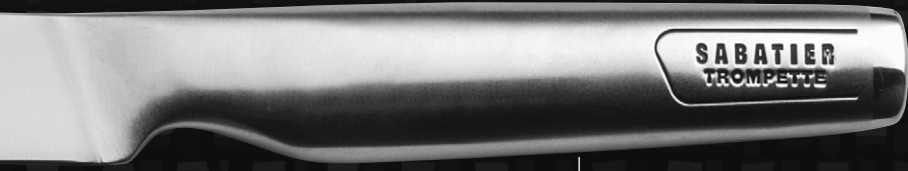

18/0 STAINLESS STEEL HANDLE



3



4



5



6

# 8780 ORIGIN

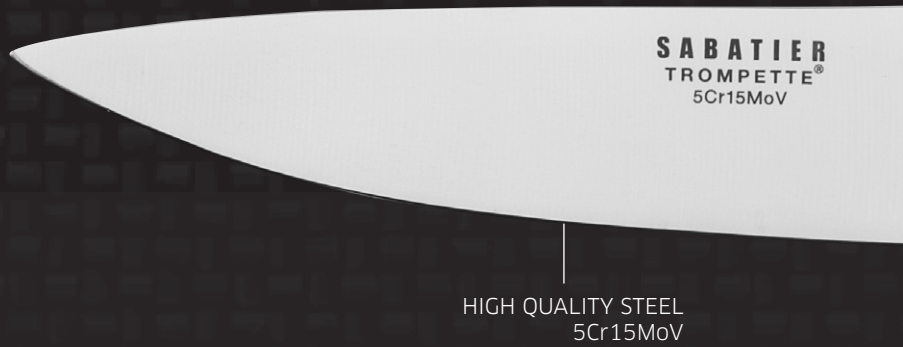

DESCRIPTION	CODE	BLADE LENGTH MM	BARCODE 354669
1 Paring knife / schilmes	112	100	9201016
2 Boning knife / uitbeenmes	227	130	9201023
3 Carving knife / vleesmes	011	180	9201047
4 Carving knife / vleesmes	196	200	9201054
5 Carving fork / vleesvork	197	180	9201061
6 Santoku knife / santoku mes	161	175	9201030
7 Chef knife / koksmes	114	150	9201122
8 Chef knife / koksmes	131	250	9201085

DESCRIPTION	CODE	BLADE LENGTH MM	BARCODE 354669
9 Chef knife / koksmes	132	200	9201078
10 Chef knife / koksmes	180	300	9201122
11 Sharpener / aanzetstaal	225	200	9201108
12 Carving knife / vleesmes	179	250	9201139
13 Ham/Salmon knife / ham/zalm mes	188	280	9201092

KITCHEN KNIVES



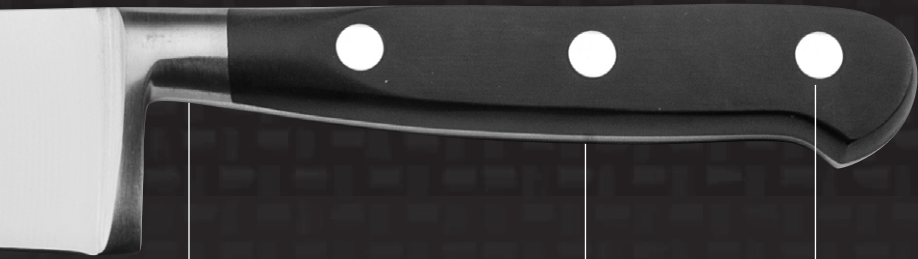

STAINLESS STEEL BOLSTER

ABS HANDLE

STAINLESS STEEL RIVETS



8

9

10

11

12

13

KITCHEN KNIVES

# 8888 PRO TECH



HIGH QUALITY STEEL  
5Cr15MoV

DESCRIPTION	CODE	BLADE LENGTH MM	BARCODE 354669
1 Boning knife / uitbeenmes	018	130	9191065
2 Sticking knife / universeelmes	015	150	9191034
3 Sticking knife / universeelmes	016	130	9191041
4 Flexible Sole knife / fileermes	142	170	9191102
5 Boning knife / uitbeenmes	017	180	9191058
6 Butcher knife / vleesmes	221	200	9191027

DESCRIPTION	CODE	BLADE LENGTH MM	BARCODE 354669
7 Butcher knife / vleesmes	222	250	9191010
8 Chef knife / koksmes	132	200	9191089
9 Chef knife / koksmes	131	250	9191096
10 Sharpener / aanzetstaal	225	250	9191072
11 Chef knife / koksmes	180	300	9191119

KITCHEN KNIVES



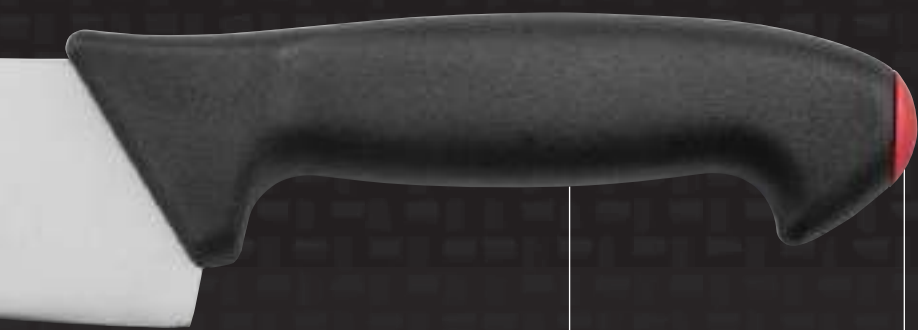

NYLON HANDLE

HACCP 5 REMOVABLE INSERTS

-  RAW MEAT
-  POULTRY
-  FISH
-  FRUIT AND VEGETABLES
-  CHEESE AND BREAD



7



8



9



10



11

KITCHEN KNIVES

# 9130 MAGNETIC RACKS

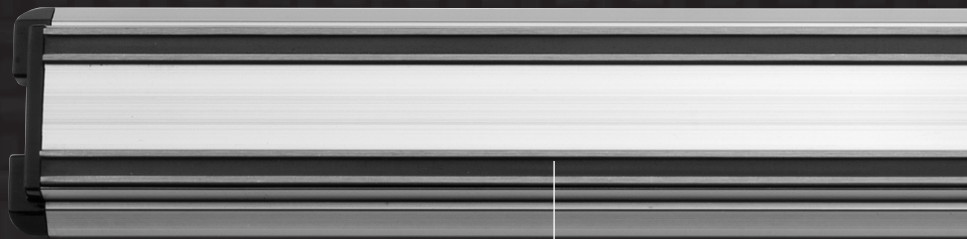

2 MAGNETIC BARS

DESCRIPTION	CODE	LENGTH MM	BARCODE 354669
1 Magnetic rack / magneet rek	125	330	9231013
2 Magnetic rack / magneet rek	123	450	9231020



1



2

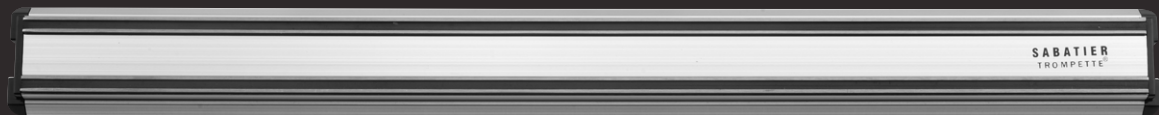



**AMEFA B.V.**

Boogschutterstraat 52  
7324 BA Apeldoorn  
The Netherlands  
Tel: +31 55 368 12 00  
Email: sales@amefa.com  
Website: www.amefa.com

