

- english
- magyar
- română

2025



**PIHER**<sup>®</sup>

# INDUSTRIAS PIQUERAS A PIQUERAS CÉG COMPANIA PIQUERAS



Original PIHER factory. Logroño, 1968  
Eredeti PIHER gyár. Logroño, 1968  
Fabrica originală PIHER. Logroño, 1968



## 1957, Logroño, La Rioja

- More than 60 years ago, the brothers Ricardo and Juan Piqueras founded Industrias Piqueras. The piston system patented by the Piqueras brothers (Piqueras HERmanos) is the true origin of the mass production of PIHER tools.
- Több mint 60 évvel ezelőtt Ricardo és Juan Piqueras testvérek megalapították az Industrias Piqueras-t. A Piqueras testvérek (Piqueras HERmanos) által szabadalmaztatott dugattyús rendszer a PIHER szerszámok tömeggyártásának igazi eredete.
- Cu mai bine de 60 de ani în urmă, frații Ricardo și Juan Piqueras au fondat Industrias Piqueras. Sistemul de piston brevetat de frații Piqueras (Piqueras HERmanos) este adevăratul origin al producției de masă a uneltelor PIHER.

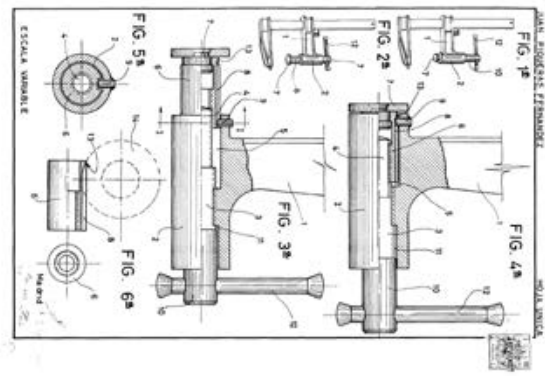

- In the 90's the founders' children continued with the traditional manufacturing values of Industrias Piqueras. At the same time they internationalized the company exporting all over the world and completing the catalogue with the inclusion of more clamping tools.
- A 90-es években az alapítók gyerekei folytatták az Industrias Piqueras hagyományos gyártási értékeit. Ugyanakkor nemzetközivé tették a céget, világszerte exportáltak, és bővítették a katalógust további szorítóeszközök bevonásával.
- În anii '90, copiii fondatorilor au continuat cu valorile tradiționale de producție ale Industrias Piqueras. În același timp, au internaționalizat compania, exportând în întreaga lume și completând catalogul prin includerea mai multor unelte de strângere.



• Office and factory headquarters of Industrias Piqueras S.A., Logroño, 2023  
• Az Industrias Piqueras S.A. irodai és gyári központja, Logroño, 2023  
• Sediul administrativ și fabrica industriilor Piqueras S.A., Logroño, 2023

- Today the PIHER factory is still linked to the region where it began, La Rioja, and to the family values with which it was founded. Since then PIHER has maintained the care for traditional tool manufacturing along with the development of new patents and continual innovation that has characterized it since its very beginnings.
- Ma a PIHER gyár továbbra is összekapcsolódik a régióval, ahol született, La Riojával, és azokkal a családi értékekkel, amelyekkel alapították. A PIHER azóta is megőrizte a hagyományos szerszámgyártás iránti gondoskodását, valamint az új szabadalmak fejlesztését és a folyamatos innovációt, amely jellemző volt rá kezdete óta.
- Astăzi, fabrica PIHER este încă legată de regiunea în care a început, La Rioja, și de valorile familiale cu care a fost fondată. De atunci, PIHER a menținut grija pentru fabricarea uneltelor tradiționale, împreună cu dezvoltarea de noi modele și inovația continuă care o caracterizează încă de la începuturile sale.



## 2025, Logroño, La Rioja

# MADE IN SPAN SPANYOLORSZÁGBAN GYÁRTVA FABRICAT IN SPANIA



## AWARDS & CERTIFICATES DÍJAK ÉS TANUSÍTVÁNYOK DIPLOME ȘI CERTIFICATE

### LYON d'OR Award Eurobois · France · 2011

- Multiprop · Outstanding New Product
- Multiprop · Kiemelkedő Új Termék
- Multiprop · Producție Nouă Remarcabilă

### TOP Product of the year Professional Builder Magazine United Kingdom · 2015

- Multiprop · Outstanding New Product
- Multiprop · Kiemelkedő Új Termék
- Multiprop · Producție Nouă Remarcabilă

### ISO 9001 QUALITY COMMITMENT

ISO 9001 MINŐSÉGBIZTOSÍTÁSI TANUSÍTVÁNY  
ISO 9001 CERTIFICAT DE CALITATE

### ISO 14001 ENVIRONMENTAL COMMITMENT ISO 14001 KÖRNYEZETKÖZPONTÚ IRÁNYÍTÁSI TANUSÍTVÁNY

ISO 14001 ANGAJAMENTUL DE MEDIU

- 78% of the tools we sell are designed and assembled in our own factory in Logroño. The network of suppliers and materials that we need to manufacture these tools does not go beyond 800km from our headquarters.
- Az általunk értékesített eszközök 78%-át saját gyárunkban, Logroño-ban tervezik és szerelik össze. Az eszközök gyártásához szükséges beszállítói és anyagellátási hálózat nem haladja meg a 800 km távolságot a központól.
- 78% dintre uneltele pe care le vindem sunt concepute și asamblate în propria noastră fabrică din Logroño. Rețeaua de furnizori și materiale de care avem nevoie pentru a fabrica aceste unelte nu depășește 800 km de sediul nostru.

- Our products are well known for their sturdiness, efficiency and versatility. PIHER has become the first choice in the professional sector when both reliability and durability are essential.

Thanks to our R+D+I department, we continually develop new tool designs and improvements to our classic tools which we immediately implement in our factory.

- Termékeinket a tartósságukról, hatékonyságukról és sokoldalúságukról jól ismerik. A PIHER az első választás a szakmai szektorban, amikor a megbízhatóság és a tartósság elengedhetetlen.

K+F+I osztályunknak köszönhetően folyamatosan új szerszámformákat és a klasszikus szerszámaink fejlesztéseit készítjük, amelyeket azonnal alkalmazunk gyárunkban.

- Produsele noastre sunt bine cunoscute pentru robustețea, eficiența și versatilitatea lor. PIHER a devenit prima alegere în sectorul profesional atunci când atât fiabilitatea, cât și durabilitatea sunt esențiale.

Grație departamentului nostru de R+D+I, dezvoltăm continuu noi modele de unelte și îmbunătățiri ale uneltelor noastre clasice pe care le implementăm imediat în fabrica noastră.

# TO THE WHOLE GLOBE AZ EGÉSZ FÖLDNEK PENTRU ÎNTREAGA LUME



## WHERE TO FIND PIHER CLAMPS? HOL TALÁLUNK PIHER SZORÍTÓKAT? UNDE POT GĂSI CLEME PIHER?

- Contact our export department to find out the nearest warehouse or store in your country to purchase PIHER clamps.
- Lépjen kapcsolatba export osztályunkkal, hogy megtudja, hol található a legközelebbi raktár vagy bolt az Ön országában, ahol PIHER szorítóit megvásárolhatja.
- Contactați departamentul nostru de export pentru a afla cel mai apropiat depozit sau magazin din țara dumneavoastră pentru a cumpăra clemele PIHER.

- Since 1990 we have included in our catalogue clamping tools manufactured abroad with the same quality guarantee. These tools represent 22% of our sales.
- 1990 óta külföldön gyártott, ugyanazzal a minőségi garanciával rendelkező szorítóeszközöinket is belefoglaltunk a katalógusunkba. Ezek az eszközök az értékesítéseink 22%-át képviselik.
- Din 1990, am inclus în catalogul nostru unelte de prindere fabricate în străinătate cu aceeași garanție de calitate. Aceste unelte reprezintă 22% din vânzările noastre.

- Our entry into foreign markets began in 1995 going to our first international fairs.  
The European continent is our main market, but we have developed a business & logistical network which enables our tools to be available all over the world.
- A külföldi piacokra való belépésünk 1995-ben kezdődött, amikor részt vettünk az első nemzetközi kiállításainkon.  
Az európai kontinens a fő piacunk, de kidolgoztunk egy üzleti és logisztikai hálózatot, amely lehetővé teszi, hogy szerszámaink világszerte elérhetőek legyenek.
- Intrarea noastră pe piețele externe a început în 1995, participând la primele noastre târguri internaționale.  
Continentul european este principala noastră piață, dar am dezvoltat o rețea de afaceri și logistică care ne permite ca uneltele noastre să fie disponibile în întreaga lume.

# SUSTAINABILITY FENNTARTHATÓSÁG SUSTENABILITATE



## ISO 14001

### ENVIRONMENTAL COMMITMENT KÖRNYEZETVÉDELMI ELKÖTELEZETTSÉG ANGAJAMENTUL DE MEDIU



#### • Durability • Tartósság • Durabilitate

- We use high quality steels and plastics. We design with a high safety factor to guarantee high performance and durability in extreme conditions.
- Csak magas minőségű acélokat és műanyagokat használunk a gyártás során. Magas biztonsági faktorttal tervezünk, hogy garantáljuk a magas teljesítményt és tartósságot szélsőséges körülmények között is.
- Folosim oțeluri și plăci de calitate superioară. Proiectăm cu un factor de siguranță ridicat pentru a garanta performanțe înalte și durabilitate în condiții extreme.



#### • Treatment • Kezelés • Tratament

- In our designs we carefully evaluate materials and processes to choose those that minimize environmental impact without sacrificing quality.
- A terveinkben gondosan értékeljük az anyagokat és folyamatokat, hogy azokat válasszuk, amelyek minimalizálják a környezeti behatást anélkül, hogy feláldoznánk a minőséget.
- În conceptele noastre, evaluăm cu atenție materialele și procesele pentru a alege pe cele care minimizează impactul asupra mediului fără a sacrifica calitatea.



#### • Repairability • Javíthatóság • Reparabilitate

- We have a wide range of spare parts for most of our tools and are constantly working to expand such. This is a key objective for our new designs
- Széles választékban kínálunk pótalkatrészeket a legtöbb szerszámunkhoz, és folyamatosan dolgozunk a bővítésükön. Ez kulcsfontosságú célkitűzés az új terveink számára.
- Avem o gamă largă de piese de schimb pentru majoritatea uneltelor noastre și lucrăm constant pentru a le extinde. Acesta este un obiectiv cheie pentru noile noastre modele.



#### • Packaging • Csomagolás • Ambalare

- We have made progress in eliminating plastic in our packaging. Piher uses blank cardboard and a limited number of inks as part of our commitment to continuous improvement
- Lépéseket tettünk a műanyag csomagolástól való eltávolításban. A Piher neutrális kartont és korlátozott számú festéket használ a folyamatos fejlődés iránti elkötelezettségünk részeként.
- Am făcut progrese în eliminarea plasticului din ambalajele noastre. Piher folosește carton simplu și un număr limitat de cerneală ca parte a angajamentului nostru pentru îmbunătățire continuă.



#### • Traceability • Nyomonkövethetőség • Trasabilitate

- Most of our parts have a traceability system for constant tracking, which allows us to identify and solve faults quickly, ensuring high quality and reliability.
- A legtöbb alkatrészünknel van nyomonkövetési rendszer, amely lehetővé teszi számunkra a folyamatos ellenőrzést, így gyorsan azonosítani és megoldani tudjuk a hibákat, biztosítva ezzel a magas minőséget és megbízhatóságot.
- Cea mai mare parte dintre piesele noastre au un sistem de trasabilitate pentru urmărirea constantă, care ne permite să identificăm și să rezolvăm rapid defectele, asigurând o calitate și o fiabilitate ridicată.



#### • Km 0 • 0 Km • 0 km

- We prioritize collaboration with nearby suppliers, who supports the regional economy and reduce the transportation carbon footprint.
- Előnyben részesítjük a közeli beszállítókkal való együttműködést, akik támogatják a helyi gazdaságot és csökkentik a szállítási szén-dioxid-kibocsátást.
- Prioritizăm colaborarea cu furnizorii din apropiere, care susțin economia regională și reduc amprenta de carbon a transportului.

BEYOND A CERTIFICATE  
**SUSTAINABILITY IS A  
 CONTINUOUS CHANGE**  
 IN HOW, WHERE AND WITH  
 WHOM WE WORK

TANUSÍTVÁNYON TÚL  
**A FENNTARTHATÓSÁG  
 EGY FOLYAMATOS VÁLTOZÁS**  
 HOGYAN, HOL ÉS KIVEL  
 DOLGOZUNK

DINCOLO DE UN CERTIFICAT  
**SUSTENABILITATEA ESTE O  
 SCHIMBARE CONTINUA**  
 CUM, UNDE ȘI CU CINE  
 LUCRĂM



 • Energy • Energia • Energie

- Thanks to our solar panels, we generate more than 70% the energy we use, so reducing our carbon footprint. This year, we aim to double our solar capacity to increase self-sufficiency and move towards a more sustainable future
- Napelemeinknek köszönhetően energiaigényünk több mint 70%-át magunk állítjuk elő, így csökkentve szén-dioxid lábnyomunkat. Idén célunk, hogy megduplázzuk napelem kapacitásunkat, hogy növeljük önellátásunkat és egy fenntarthatóbb jövő felé haladjunk.
- Datorită panourilor noastre solare, generăm mai mult de 70% din energia pe care o folosim, reducând astfel amprenta noastră de carbon. Anul acesta, ne propunem să ne dublăm capacitatea solară pentru a crește autosuficiența și a ne îndrepta spre un viitor mai sustenabil.



- We are partners in the Economy for the Common Good as a pioneer company and we are moving forward in the implementation of its goals, with the aim of contributing to a more ethical and sustainable economic model
- Parteneri în relație în cadrul proiectului „Economy for the Common Good” ca o companie pionieră și ne îndreptăm în implementarea obiectivelor sale, cu scopul de a contribui la un model economic mai etic și sustenabil.



- Piher is a partner of Som Energia and use 100% certified renewable energy, committed to a more sustainable, ethical and environmentally friendly energy model.
- A Piher a Som Energia partnere, és 100%-ban tanúsított megújuló energiát használ, elkötelezett a fenntarthatóbb, etikusabb és környezetbarát energia modell iránt.
- Piher este un partener al Som Energia și folosește 100% energie regenerabilă certificată, angajându-se să promoveze un model energetic mai durabil, etic și prietenos cu mediul.



- We are partners and collaborate with Fiare, a non-profit ethical banking project, committed to a more responsible and fair financial system
- Partnerek vagyunk és együttműködünk a Fiare-val, egy non-profit etikus banki projekttel, amely elkötelezett a felelősebb és igazságosabb pénzügyi rendszer mellett.
- Suntem parteneri și colaborăm cu Fiare, un proiect de bancă etică nonprofit, dedicat unui sistem financiar mai responsabil și echitabil.



- We collaborate with associations that help people with disabilities, supporting their social integration and promoting their autonomy. We are committed to initiatives that promote an inclusive and accessible environment for all.
- Együttműködünk olyan egyesületekkel, amelyek segítik a fogyatékkal élőket, támogatva a társadalmi integrációjukat és elősegítve önállóságukat. Elköteleztük magunkat az olyan kezdeményezések mellett, amelyek egy inkluzív és hozzáférhető környezetet népszerűsítenek mindenki számára.
- Colaborăm cu asociații care ajută persoanele cu dizabilități, sprijinind integrarea lor socială și promovând autonomia acestora. Ne angajăm în inițiative care promovează un mediu inclusiv și accesibil pentru toți.



- We finance and use open source software on a daily basis, supporting the development of technological solutions that are open and accessible to all.
- Minden nap finanszírozzuk és használjuk a nyílt forráskódú szoftvereket, támogatva a technológiai megoldások fejlesztését, amelyek nyitottak és mindenki számára elérhetők.
- Finanțăm și folosim software open source zilnic, susținând dezvoltarea de soluții tehnologice care sunt deschise și accesibile tuturor.

# SPONSORSHIP & COLLABORATIONS

## SZPONZORÁLÁS ÉS EGYÜTTMŰKÖDÉSEK

### SPONSORIZARE ȘI COLABORĂRI



- Since 2022 Piher has been an official sponsor of the Spain Skills 2022 vocational training college competition in the Carpentry and Joinery categories. We have provided our clamping tools for each of the young participants.
- 2022 óta a Piher hivatalos szponzora a Spain Skills 2022 szakmai szakképzőiskolai versenyeknek a faipari és asztalos kategóriákban. Minden fiatal résztvevő számára biztosítják a szorítóeszközöket.
- Încă din 2022, Piher a fost sponsor oficial al competiției de colegii de formare profesională Spain Skills 2022 în categoriile Îndemânare în prelucrarea lemnului și Dresaj de lemn. Am furnizat unelte noastre de fixare pentru fiecare dintre tinerii participanți.

- In the WorldSkills 2025 global competition, Piher has sponsored the Spanish representatives in the disciplines of carpentry and cabinetmaking. We also collaborate with Profemadera, the Spanish Association of Woodworking and Cabinet Making teachers
- A 2025-ös WorldSkills világversenyen a Piher támogatta a spanyol képviselőket a famegmunkálás és bútorasztalosság területein. Emellett együttműködünk a Profemadera-val, a Famegmunkálási és Bútorasztalossági Tanárok Spanyol Egyesületével.
- În competiția globală WorldSkills 2025, Piher a sponsorizat reprezentanții spanioli în disciplinele de dulgherie și fabricare de mobilier. De asemenea, colaborăm cu Profemadera, Asociația Spaniolă a Profesorilor de Prelucrarea Lemnului și Fabricarea Mobilierului.

WE SUPPORT THE TRADITION AND THE FUTURE OF THE TRADE WITH OUR TOOLS

TÁMOGATJUK A KERESKEDELEM HAGYOMÁNYÁT ÉS JÖVŐJÉT ESZKÖZEINKKEL

SUSȚINEM TRADIȚIA ȘI VIITORUL COMERȚULUI CU UNELTELE NOASTRE



- We cooperate with Albaola since 2017 to supply every clamping tool they need. They are building a historical replica of the San Juan, a whaling ship built in the 16th century in the same port where they are located now. This project has Unesco recognition.
- 2017 óta együttműködünk az Albaola-val, hogy biztosítsuk számukra az összes szükséges szorítóeszközt. Egy történelmi másolatot építenek a San Juanról, egy 16. századi bálnavadász hajóról, amelyet abban a kikötőben építettek, ahol most is találhatóak. Ez a projekt UNESCO-elismerésben részesült.
- Cooperăm cu Albaola din 2017 pentru a le furniza fiecare unelte de prindere de care au nevoie. Aceștia construiesc o replică istorică a lui San Juan, o navă de vânătoare de balene construită în secolul al XVI-lea în același port în care se află acum. Acest proiect are recunoașterea Unesco.
- Drakkar de Vendée is a partnership that aims to build a replica of a 9th century Viking longship in the Les Sables d'Olonne region of the Vendée, France. To carry out this ambitious project, the association has the support of various partners, including PIHER.
- A Drakkar de Vendée egy olyan partnerség, amelynek célja egy 9. századi viking hosszúhajó másolatának megépítése a franciaországi Vendée Les Sables d'Olonne régiójában. Ennek az ambiciózus projekthez az egyesület különböző partnerek támogatását élvezti, beleértve a PIHER-t is.
- Drakkar de Vendée este un parteneriat care își propune să construiască o replică a unei nave vikinge din secolul al IX-lea în regiunea Les Sables d'Olonne din Vendée, Franța. Pentru a duce la bun sfârșit acest proiect ambițios, asociația beneficiază de sprijinul diverselor parteneri, inclusiv PIHER.

**MULTIPROPS**  
MULTIPROPS  
MULTIPROPS

11-19



**MULTICLAMPS**  
MULTICLAMPS  
MULTICLAMPS

20-25



**RED LINE LAMPS**  
BORDÓ SZORÍTÓ SOROZAT  
ETRIERE DE LINIE ROȘIE

26-33



XXL

**BLUE LINE CLAMPS**  
KÉK SZORÍTÓ SOROZAT  
ETRIERE LINIE ALBASTRĂ

34-38



**SASH CLAMPS**  
TOKOZAT SZORÍTÓK  
CUREA DE STRĂNGERE

39

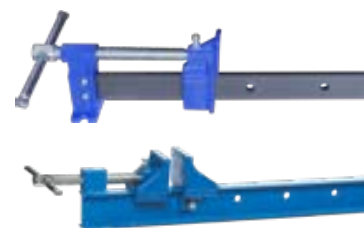

**ACCESSORIES**  
KIEGÉSZÍTŐK  
ACCESORII

40-41



**G-CLAMPS**  
G-SZORÍTÓK  
CLEME-G

42



**PARALLEL JAW CLAMPS**  
KORPUSZ SZORÍTÓK  
CLEME CU MAXILARE PARALELE

43-49



**ONE-HAND CLAMPS**  
EGYKEZES SZORÍTÓK  
CLEME ACȚIONARE CU O MÂNĂ

50-57





**GUIDES & TABE CLAMPS**  
VEZETŐSÍN ÉS ASZTALI LESZORÍTÓK  
ȘINE DE CONDUCERE ȘI CLEME DE MASĂ

58



**SPRING CLAMPS**  
CSIPESZEK  
CLEME CU ARC

59-60



**PROFESSIONAL STRAP CLAMPS**  
PROFESZIONÁLIS SZALAGOS SZORÍTÓK  
CLEME PROFESIONALE BANDA

61-64



**EDGE-GRIP SCREWS**  
ÉL- ÉS HOMLOKSZORÍTÓK  
CLEME PENTRU MUCHIE ȘI FATA

65

**ANGLE CLAMPS**  
SZÖG- ÉS SAROKSZORÍTÓK  
CLEME PENTRU COLȚURI ȘI MARGINI

66



**BENCH VICES**  
ASZTALI SATUK  
MENGHINE DE MÂNĂ

67-68



**FOR WORKING ON METAL & WOODEN HOLED TABLES**  
FA ÉS FÉM FURATOS MUNKAASZTALOKON VÉGZETT MUNKÁHOZ  
PENTRU LUCRU PE MESE DIN METAL ȘI LEMN CU GĂURII

69-83





**TOGGLE CLAMPS**  
KÖNYÖKEMELŐS GYORSSZORÍTÓK  
CLEME RAPIDE

84-87





**LOCKING PLIERS**  
ÖNZÁRÓ FOGÓK  
CLEȘTI DE BLOCARE

88-90



**WELDING TOOLS**  
SZERSZÁMOK HEGESZTÉSHEZ  
UNELTE DE SUDARE

91



**SUCTION CUPS**  
VÁKUUMOS EMELŐK  
VENTUZE

92-95



**LIFTERS & TRANSPORTERS**  
EMELŐK ÉS HORDOZÓK  
SCRIPETE ȘI TRANSPORTOARE

96

**SAW HORSES & SUPPORTS**  
TARTÓBAKOK ÉS TÁMASZTÉKOK  
CAPRĂ ȘI SUPORTURI

97





**DISPLAY STAND**  
BEMUTATÓÁLLVÁNYOK  
STANDURI DE AFISARE

98-99



 **PIHER Production**  
PIHER gyártmány  
Producția PIHER

 **Woodworking & Carpentry**  
Asztalosipar és faipar  
Tamplarie și dulgherie

 **Light work**  
Könnyű munka  
Lucru ușor

 **Metalworking & Welding**  
Fémegmunkálás és hegesztés  
Prelucrarea metalelor și sudura

 **Building**  
Épület  
Clădire

 **Motor & Mechanics**  
Motor és mechanika  
Motor și Mecanică

 **Maximum Pressure**  
Maximális nyomóerő  
Presiune maximă

 **Bar Thickness**  
Sínméret  
Grosimea barei

 **Maximum opening**  
Maximális nyitás  
Deschidere maximă

 **Maximum depth**  
Maximális mélység  
Adâncimea maximă

 **Clamping depth**  
Szorítás mélysége  
Adâncimea de fixare

 **Diameter**  
Átmérő  
Diametru

 **Units per box**  
Egységek dobozonként  
Unități pe cutie

 **Blister packaging**  
Bliszteres csomagolás  
Ambalaj blister

 **Minimum Multiprop length**  
Minimális Multiprop hossz  
Lungimea minimă a Multiprop

 **Maximum Multiprop length**  
Maximális Multiprop hossz  
Lungimea maximă a Multirop

 **Maximum Suction capacity (horizontally)**  
Maximális szívókapacitás (vízszintesen)  
Capacitate maximă de aspirație (orizontal)

 **Maximum Suction capacity (vertically)**  
Maximális szívókapacitás (függőlegesen)  
Capacitate maximă de aspirație (vertical)

 **Maximum magnetic holding capacity**  
Maximális mágneses tartóerő  
Capacitate maximă de retenție magnetică

 **Width and height of bar clamp**  
A szorító szélessége és magassága  
Lățimea și înălțimea clemei de bară

 **Spring clamp length**  
Csipesz hossz  
Lungime clește

 **Electric current in amps**  
Elektromos áram amperben  
Curent electric în amperi

**Tn**  
Tonna – erő  
Ton-forță



**Tool to be customised by the user**  
Eszköz, amelyet a felhasználó testre szabhat  
Instrument de personalizat de către utilizator



**New tool or new use**  
Új eszköz vagy új használat  
Un nou instrument sau o nouă utilizare



**Oil free reinforced plastic, no marks left**  
Olajmentes megerősített műanyag, nem hagy nyomot  
Plastic întărit fără ulei, fără urme lăstate



**New in stock through 2025**  
Újdonság a készleten 2025-től  
Noutate în stoc din 2025

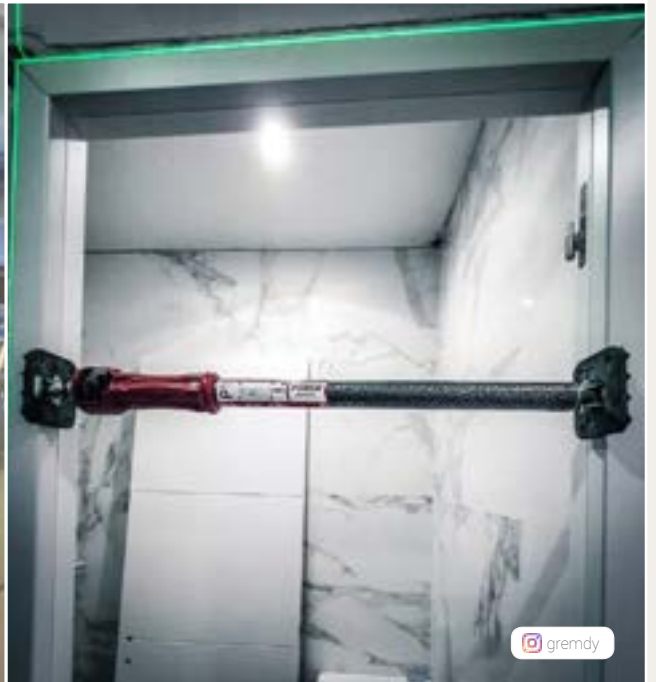

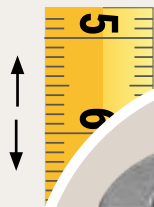
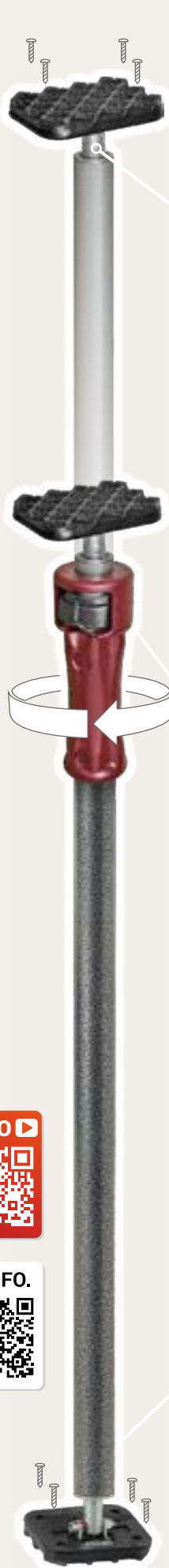

- Accurate screw adjusted extra expansion with threaded bushing made of steel.
- Acél állítócsavar és hüvely a nagyobb feszítés érdekében.
- Șurub de ajustare din oțel și manșon pentru o tensiune mai mare.



- Multi-disc system for quick expansion and instant braking
- Több gyűrűs rendszer a gyors bővítéshez és az azonnali záráshoz.
- Un sistem cu mai multe inele pentru expansiune rapidă și închidere imediată.

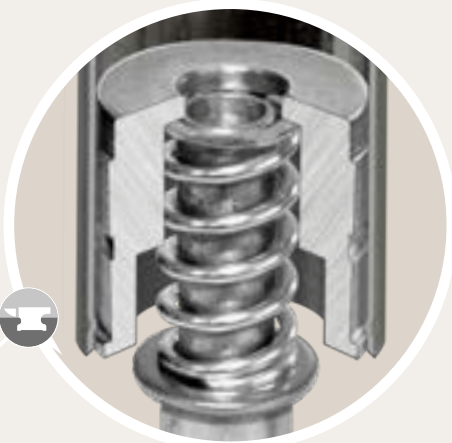

- Spring mechanism for quick locking, with threaded bushing made of steel.
- Rugós mechanizmus a gyors rögzítéshez, acélmenetes hüvellyel.
- Mecanism cu arc pentru prindere rapidă, cu manșon filetat din oțel.

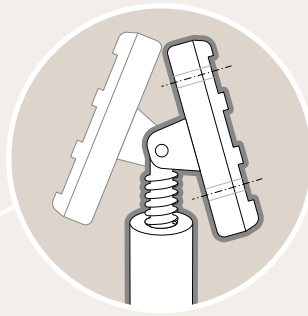

- Tilting non-slip pads adjustable to any angle with holes to assemble to any surface.
- Bármilyen irányba és szögbe rögzíthető és beállítható csúszásmentes pad, furatai által bármilyen felülettel összeszerelhető.
- Un tampon anti-alunecare poate fi fixat și ajustat în orice direcție și unghi, și poate fi asamblat cu orice suprafață prin orificiile sale.

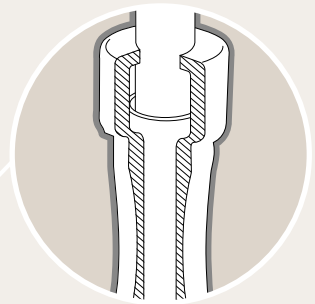
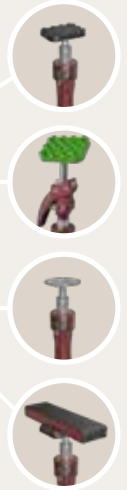

- Nylon fiberglass reinforced handle.
- Nylon üvegszál erősítésű fogantyú.
- Mâner din fibră de sticlă întărit cu nylon.

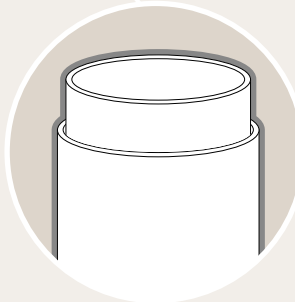

- 1 mm thick steel tubes.
- 1 mm vastag acélsövek.
- Tubi de oțel de 1 mm grosime.

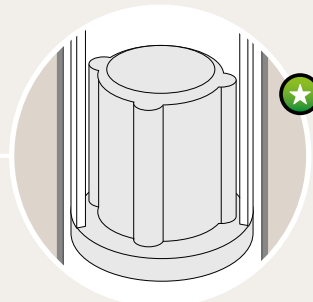

- New shock absorber that improves guidance between tubes, prevents vibration noise and softens the shock of the inner tube falling.
- Új ütközésgátló, amely javítja a csövek közötti mozgást, megakadályozza a rezgési zajt és tompítja a belső cső leesésének károsító hatását.
- Noua barieră de coliziune care îmbunătățește mișcarea între țevi, previne zgomotul de vibrație și atenuează efectul dăunător al căderii țevii interioare.





## MAXIPROP

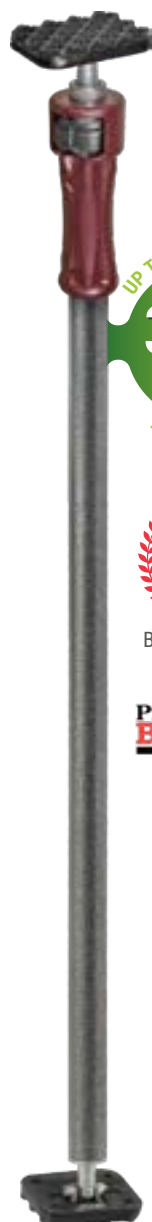

UP TO • TERHELHETŐ  
**300**  
KG  
ÎNCĂRCABIL



BEST PRODUCT  
OF THE YEAR  
UK 2015

**Professional  
BUILDER**  
MAGAZINE

- The suggested loads are the result of using a safety margin of 1.5 in each test. For example: if the suggested load is 300 kg in the test we have applied 450 kg and the tool still shows no damage.\*
- A javasolt terhelések egy 1,5-ös biztonsági tartalék alkalmazásának eredményei minden egyes teszten. Például: ha a javasolt terhelés 300 kg a teszt során, akkor 450 kg-ot alkalmaztunk, és az eszköz még mindig nem mutat sérülést.\*
- Încărcăturile sugerate sunt rezultatul utilizării unei marje de siguranță de 1,5 în fiecare test. De exemplu: dacă încărcătura sugerată este de 300 kg în test, am aplicat 450 kg și unelte nu prezintă nicio deteriorare.\*

\* We are not responsible for any misuse of the Multiprop. Carefully read the instructions for use, maintenance and storage that we attach to each tool.

\* Nem vállalunk felelősséget a Multiprop bármilyen helytelen használatáért. Gondosan olvassa el a használati, karbantartási és tárolási utasításokat, amelyeket minden szerszámhoz mellékelünk.

\* Nu suntem responsabili pentru orice utilizare greșită a Multiprop. Citiți cu atenție instrucțiunile de utilizare, întreținere și depozitare pe care le atașăm fiecărui instrument.

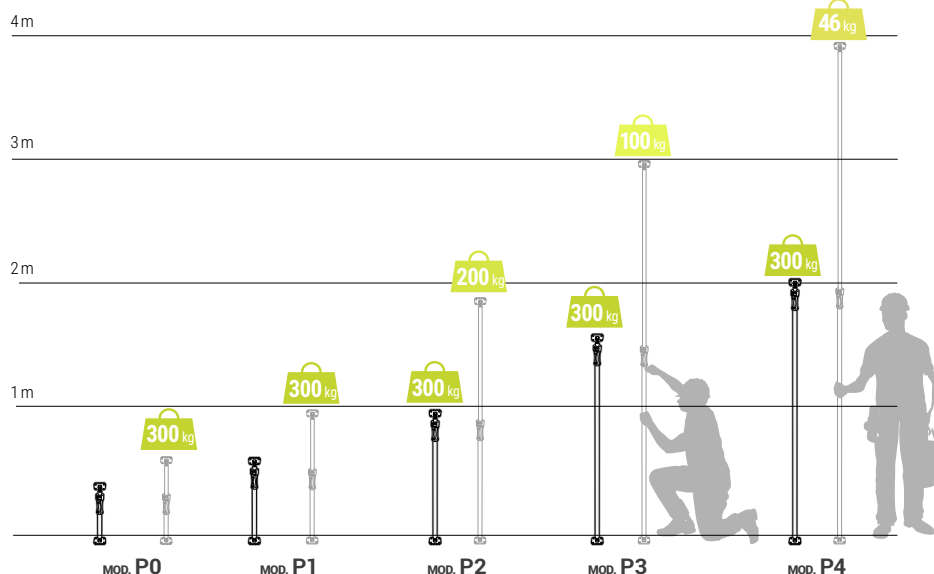

COD	MOD	min.	Max.	kg	
34000	<b>P0</b>	40 cm	60 cm	1,1	5
30010	<b>P1</b>	60 cm	100 cm	1,36	
30011	<b>P2</b>	95 cm	170 cm	1,81	
30012	<b>P3</b>	155 cm	290 cm	2,61	
34004	<b>P4</b>	200 cm	375 cm	3,18	

### LIGHT PROP ACCESSORIES SYSTEM • MULTIPROP KIEGÉSZÍTŐI • SISTEM DE ACCESORII MULTIPROP

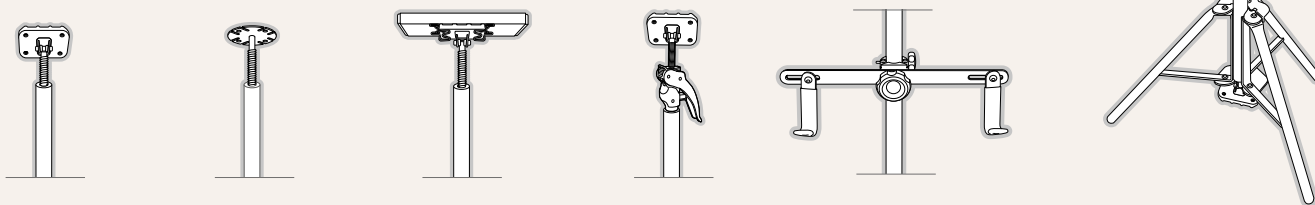



**SPARE PADS • TARTALÉK TALPAK • PADS DE REZERVĂ**

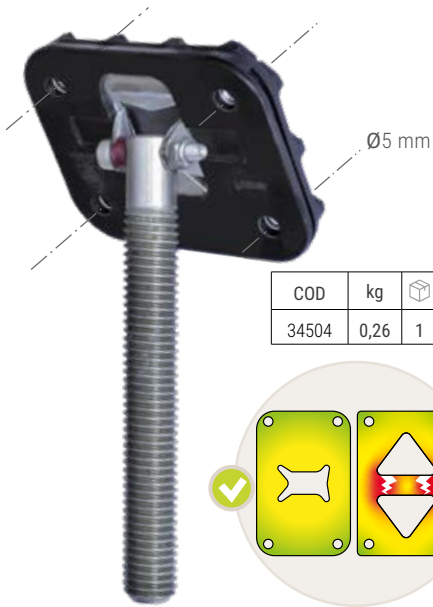

COD	kg	☐
34504	0,26	1

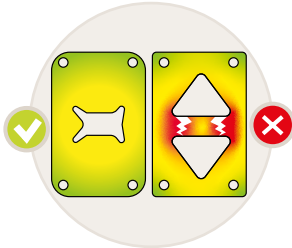

- 2.5 mm thick steel core with ribs and tie points that distribute pressure evenly.
- 2,5 mm vastag acélbelső, bordákkal és rögzítési pontokkal, amelyek egyenletesen elosztják a nyomást.
- Miez de oțel de 2,5 mm grosime cu nervuri și puncte de legătură care distribuie presiunea uniform.



COD	kg	☐
34502	0,10	1

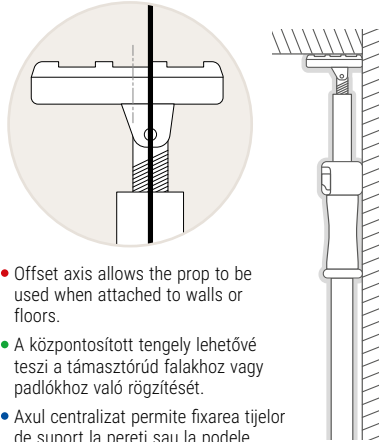

- Offset axis allows the prop to be used when attached to walls or floors.
- A központosított tengely lehetővé teszi a támasztórúd falakhoz vagy padlókhöz való rögzítését.
- Axul centralizat permite fixarea tijelor de suport la pereții sau la podele.

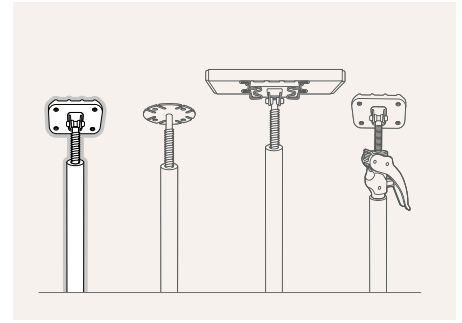

**FIX PAD KIT • FIX TALP KÉSZLET • KIT DE TALPA FIXA**



COD	kg	☐
34039	0,39	1

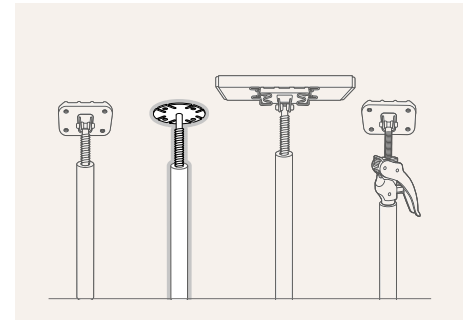

- Wholly in steel
- Screw holes and slots for fixing metal or wooden supports.
- Keeps supports parallel
- Locks Multiprop spring system to improve accuracy and security in levelling work

- Acél kivitel
- Rögzítőfuratok és rések fém vagy fa tartók rögzítéséhez.
- Párhuzamosság tartása
- Multiprop rugós rendszer zárása a pontosság és biztonság javítása érdekében a szintezési munkák során

- Executie din oțel
- Găuri de fixare și sloturi pentru fixarea suporturilor metalice sau de lemn.
- Menținerea paralelismul ui
- Închiderea sistemului cu arc Multiprop pentru a îmbunătăți precizia și siguranța în timpul lucrărilor de nivelare.

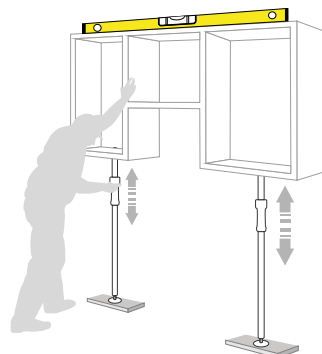



EXTRA LONG ANTISLIP PADS • EXTRA HOSSZÚ CSÚSZÁSMENTES ALÁTÁMASZTÓ • TALPI ANTISLIP EXTRA LUNGHI



Quick installation system  
Gyors csatlakoztatási rendszer  
Sistem de instalare rapidă

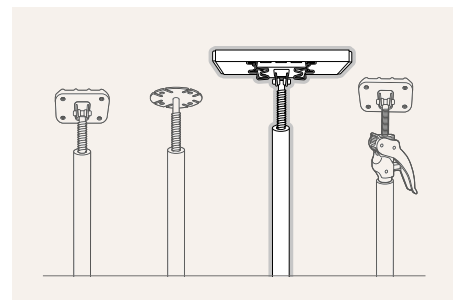

COD	A cm	B cm	kg	☐
34036	6	20	0,13	4
34037	6	35	0,21	
34038	6	70	0,38	1

- Aluminium body.
- Stainless steel springs.
- EPDM rubber anti-slip surface.

- Aluminiu ház.
- Rozsdamentes acél rugók.
- EPDM gumból készült csúszásgátló felület.

- Carcasă din aluminiu.
- Arcuri din oțel inoxidabil.
- Suprafață anti-derapantă din cauciuc EPDM.

ACCESSORY ARM+ • KIEGÉSZÍTŐ ARM+ • ACCESORIU ARM+

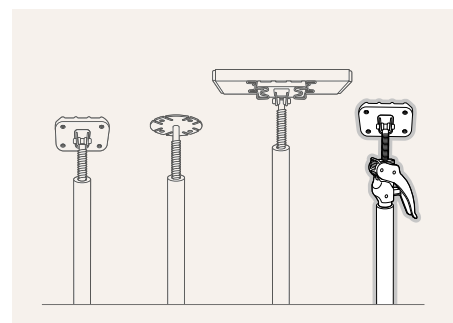
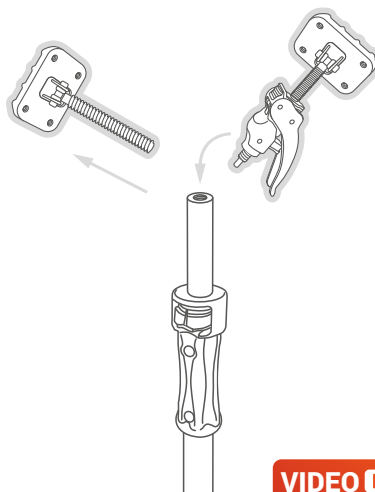

COD	kg	☐
34089	0,51	2

- Easy single hand use
- 100 kg (220lb) Load capacity
- Manufactured in steel and fibreglass reinforced nylon.
- Tilting non-slip pads adjustable to any angle
- For all of our Maxirops.
- Don't turn the handle if an accessory is used.

- Egyszerű egykezes használat
- 100 kg (220lb) teherbírás
- Acélból és üvegszállal megerősített nylonból készült.
- Dönthető, csúszásmentes talp, bármilyen szögben állítható
- Minden Multiprop-hoz alkalmazható.
- Ne fordítsa el a fogantyút, ha tartozékot használ.

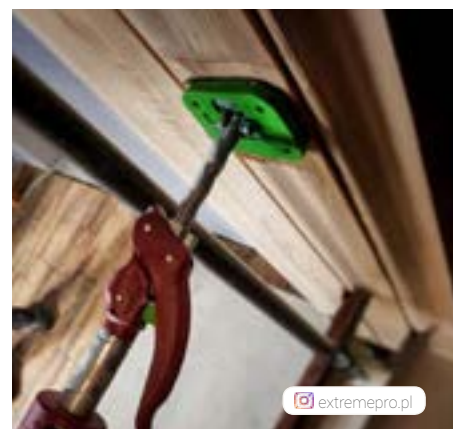

- Utilizare ușoară cu o singură mână
- Capacitate de încărcare de 100 kg (220 lb)
- Fabricat din oțel și nailon întărit cu fibră de sticlă.
- Pad-uri antiderapante inclinabile ajustabile la orice unghi
- Pentru toate Multirops-urile noastre.
- Nu rotiți mânerul dacă se folosește un accesoriu.



OWN MAKE & DESIGN MADE IN SPAIN  
SAJÁT KÉSZÍTÉS ÉS TERVEZÉS,  
SPANYOLORSZÁGBAN KÉSZÜLT  
PRODUCȚIE ȘI DESIGN PROPRIE,  
FABRICAT ÎN SPANIA

# MULTIPROPS MULTIPROPS MULTIPROPS

MULTIPROP ARM+P3 • MULTIPROP ARM+P3 • MULTIPROP ARM+P3

COD	kg	☐
34093	2.86	5



168 cm



318 cm  
300 cm

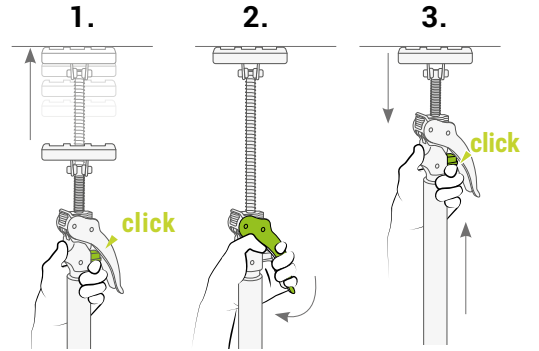
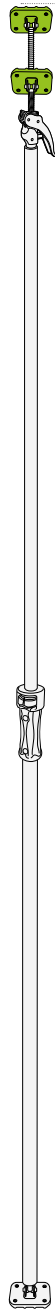

- Fast adjusment.
  - Gyors beállítás, kiengedés.
  - Ajustare rapidă.
- Increase pressure and distance.
  - Feszítés, finom beállítás.
  - Tensiune, ajustare fină.
- Compress spring and release pressure.
  - A rúgó összenyomása és tehermentesítés.
  - Comprimați arcul și eliberați presiunea.

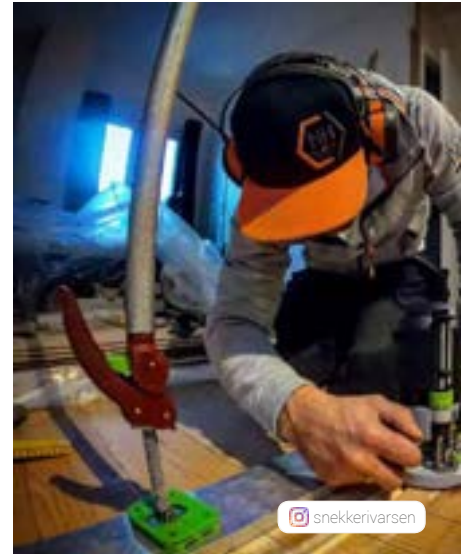



OWN MAKE & DESIGN MADE IN SPAIN  
SAJÁT KÉSZÍTÉS ÉS TERVEZÉS,  
SPANYOLORSZÁGBAN KÉSZÜLT  
PRODUȚIE ȘI DESIGN PROPRIE,  
FABRICAT ÎN SPANIA

## MULTIPROPS MULTIPROPS MULTIPROPS

### MULTIPROP HOLDALL • MULTIPROP HOLDALL • MULTIPROP HOLDALL

- Made of cotton
- Pamutból készült
- Fabricat din bumbac
- 16 kg Load Capacity.
- 16 kg teherbírás.
- Capacitate de încărcare de 16 kg.



COD	kg	Maximum capacity Maximális tárolókapesség Capacitate maximă de stocare	Length Hosszúság Lungime	Kg Max. Recommended Weight Kg Max. Ajánlott súly Kg Max. Greutatea recomandată	
93049	0,65	5 x P3	165 cm	13	1
93050	0,70	4 x P4	210 cm	12	1

### MULTIPURPOSE ADJUSTABLE HANGER • TÖBBCÉLÚ ÁLLÍTHATÓ AKASZTÓ • CUIER REGLABIL MULTIFUNȚIONAL

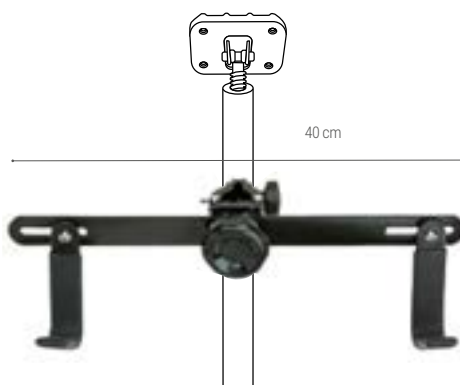

- Made of steel
- Hooks with plastic protectors.
- Adjustable for tubes from Ø25 mm to 30 mm.
- 25 kg. Load Capacity .
- Acélből készült
- Műanyag védőkkel ellátott kampók.
- Ø25 mm-től 30 mm-ig állítható csőrögzítő bilincs.
- 25 kg. Teherbírás.
- Fabricat din oțel
- Cârlige cu protecții din plastic
- Cleme de prindere a tubului ajustabile de la Ø25 mm la 30 mm
- Capacitate de încărcare 25 kg.

COD	kg	
30015	0,9	1

### TRIPOD • TRIPOD ÁLLVÁNY • TRIPOD

- Load capacity: 300 kg
- Welded tubes and profiles.
- For our Maxirop and for Ø30 mm tubes.
- New Easy set up and One click release
- Teherbírás: 300 kg
- Hegesztett csövek és profilok.
- Multiprop-hoz és a Ø30 mm-es csövekhez használható.
- Új egyszerű beállítás és egy kattintásos kioldás.
- Capacitate de încărcare: 300 kg
- Tuburi și profile sudate.
- Pentru Multiprop-ul nostru și pentru tuburi de Ø30 mm.
- Nou: setare ușoară și eliberare cu un singur clic.

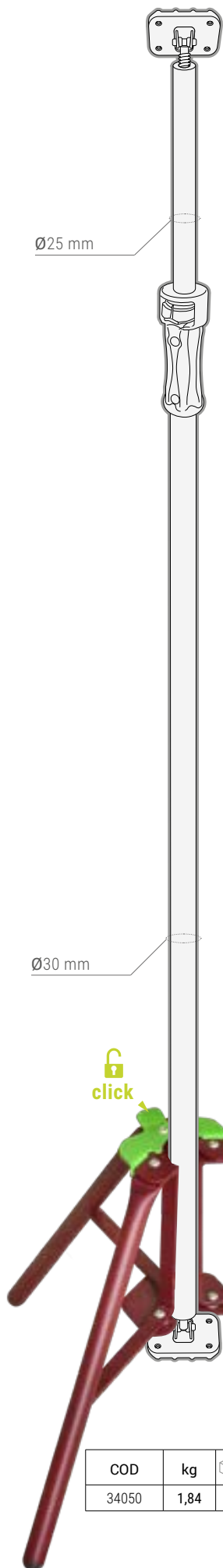

COD	kg	
34050	1,84	1





- Automatic magnetic strip closure
- No zip. No hands needed to open or to close.
- Includes 2 Multiclamps with a pressed eye, door and steel lintel.
- Self-closing action maintains a tight seal.
- For walls or doorways in anti-dust sealed work areas
- Multipositional door: ground level, elevated, centred, aside, etc.
- Maximum lintel length: 130cm
- Doorway aperture height: 200cm
- Reusable
- Usable with Piher Maxiprops (not included)

- Automatikus mágnescsíkos függőnyzár
- Nincsen cipzár. Nyitáshoz vagy záráshoz nincs szükség kézre.
- Tartalmaz 2 Multiclamp-et zárt szemű csavarral, ajtó és küszöb vasalatot.
- Önmagát záró mechanizmus, amely tömör zárást biztosít.
- Falakra vagy ajtókeretekbe rakható, pormentes munkaterületet hoz létre.
- Több pozícióban alkalmazható függöny: magasba, emelten, közepén, oldalt stb.
- Maximális nyílás szélesség: 130 cm.
- Ajtónyílás magassága: 200 cm.
- Újrahasználatos.
- Használható Piher Multiprop-pal (nem tartozék).

- Zăvor automatic cu bandă magnetică
- Nu are fermoar. Nu este nevoie de mână pentru deschidere sau închidere.
- Include 2 Multiclamp cu șurub cu ochi închis, accesorii pentru ușă și praguri.
- Mecanism de autoînchidere care asigură o închidere etanșă.
- Poate fi montat pe pereți sau rame de ușă, creând un spațiu de lucru fără praf.
- Cortină aplicabilă în mai multe poziții: sus, înălțat, la mijloc, lateral etc.
- Lățimea maximă a deschiderii: 130 cm.
- Înălțimea deschiderii ușii: 200 cm.
- Reutilizabil.
- Poate fi folosit cu Piher Multiprop (nu este inclus).

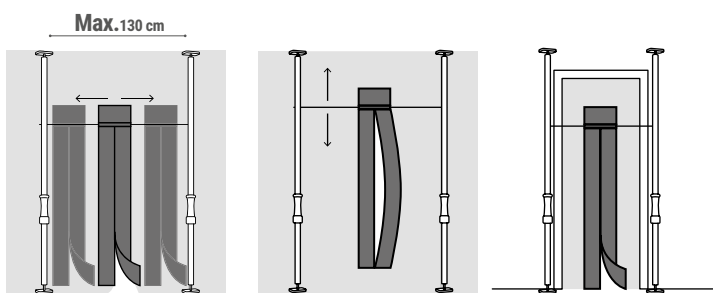
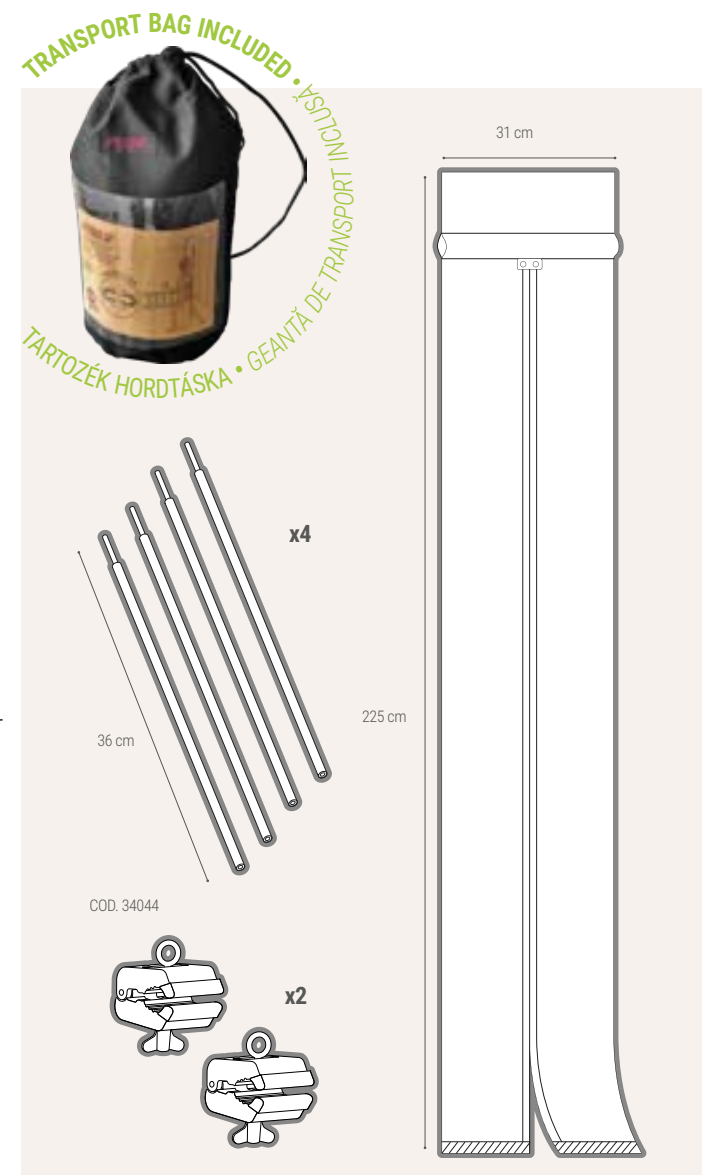

**Anti-Dust Magnetic Door**  
Mágneses függöny  
Cortină magnetică



**How to Install the Piher Anti-Dust Magnetic Door**  
Hogyan kell telepíteni a Piher mágneses függőnyt  
Cum să instalați cortina magnetică Piher



**How to Store the Piher Anti-Dust Magnetic Door**  
Hogyan kell tárolni a Piher mágneses függőnyt  
Cum se păstrează cortina magnetică Piher



CEILING WORK KIT • MENNYEZET SZERELÉSI ÖSSZEÁLLÍTÁS • CONFIGURARE MONTARE TAVAN



COD	kg	
34017	8	1

INCLUDED • TARTALMA • INCLUS	COD	
Multiprop 3 Multiprop 3 Multiprop 3	30012	2x
Multiprop Holdall Multiprop Holdall Multiprop Holdall	93049	1x
Accessory Arm+ Kiegészítő Arm+ Accesoriu Arm+	34089	2x
Extra Long Antislip Pads 35 mm Extra hosszú csúszásmentes alátámasztó 35 mm Paduri antislip extra lunghi 35 mm	34037	2x

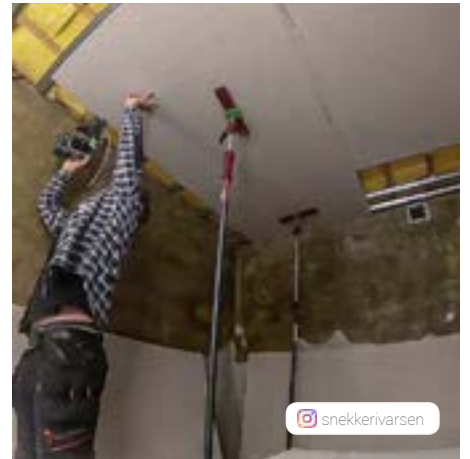

ANTI-DUST KIT • MÁGNESES FÜGGÖNY ÖSSZEÁLLÍTÁS • ASAMBLARE CORTINĂ MAGNETICĂ



COD	kg	
34018	8	1

INCLUDED • TARTALMA • INCLUS	COD	
Anti-Dust Magnetic Door Mágneses függöny Cortină magnetică	34110	1x
Multiprop 3 Multiprop 3 Multiprop 3	30012	2x
Multiprop Holdall Multiprop Holdall Multiprop Holdall	93049	1x
Scotch Tape Ragasztószalag Bandă adezivă		1x
200 x 125 cm Plastic Sheet 200 x 125 cm Nylon fólia Folie din nailon 200 x 125 cm		1x

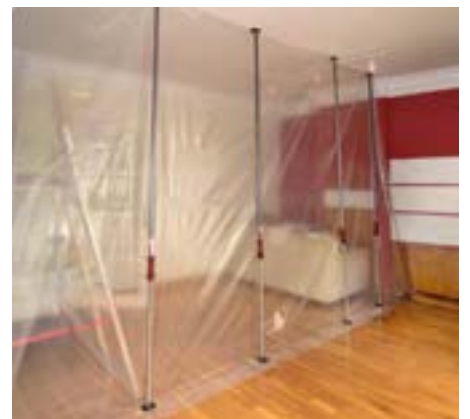



OWN MAKE & DESIGN MADE IN SPAIN  
SAJÁT KÉSZÍTÉS ÉS TERVEZÉS,  
SPANYOLORSZÁGBAN KÉSZÜLT  
PRODUCȚIE ȘI DESIGN PROPRIE,  
FĂBRICAT ÎN SPANIA

MULTICLAMPS  
MULTICLAMPS  
MULTICLAMPS

PATENTED DESIGN  
SZABADALMOZTATOTT FORMATERVEZÉS  
DESIGN PATENTAT



- Nylon with fibreglass jaws.
- Nylon üvegszál erősítésű pofák
- Nylon cu unelte din fibră de sticlă.

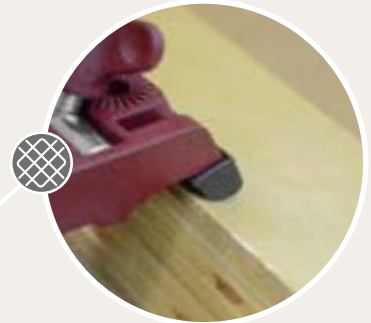

- Removable non-slip pads.
- Cserélhető, csúszásmentes pofák.
- Tamponae schimbabile, antiderapante.

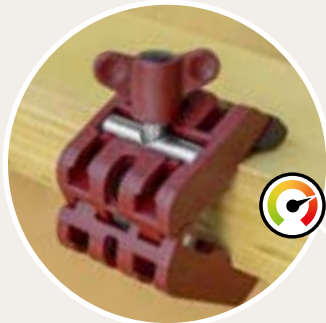

- Maximum pressure 75 kg (330lb)
- Maximális szorítóerő 75kg (330 lb)
- Forța maximă de strângere 75 kg (330 lb)

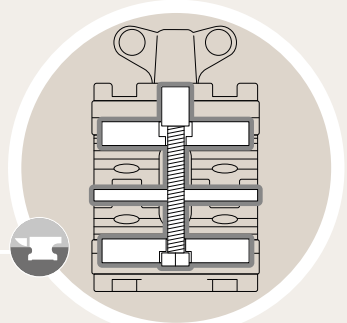

- Screw, axis and reinforcements made of steel.
- Csavar, valamint acéltengelyes megerősítés.
- Șurub, precum și armătura axului de oțel.

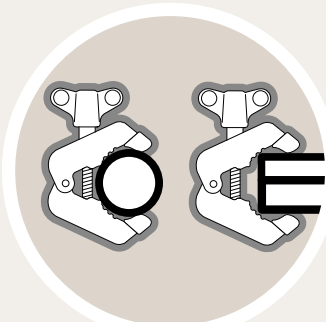

- For flat and contoured surfaces, tubes...
- Sík, kontúros felületekhez, csövekhez...
- Pentru suprafețe plane, conturate, țevi...



- Useful for narrow diameters.
- Kis átmérőjű munkadarabokhoz is kiválóan használható.
- Este de asemenea excelent pentru lucrări cu diametru mic.

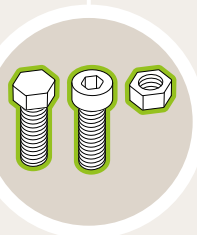

### ASSEMBLE WHAT YOU WANT

Multiple screw and nut holes (M6, M8 and W 1.4")

### ÁLLÍTSD ÖSSZE AZT, AMIT SZERETNÉL.

Több csavar és rögzítőfurat (M6, M8 és W ¼")

### ASAMBLEAZĂ CEEA CE VREI

Mai multe șuruburi și găuri de fixare (M6, M8 și W ¼")

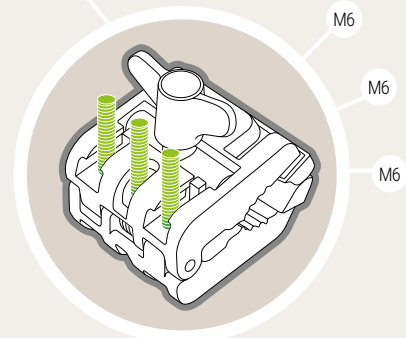
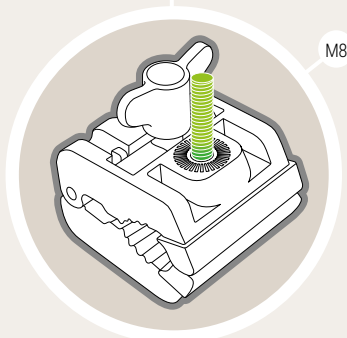
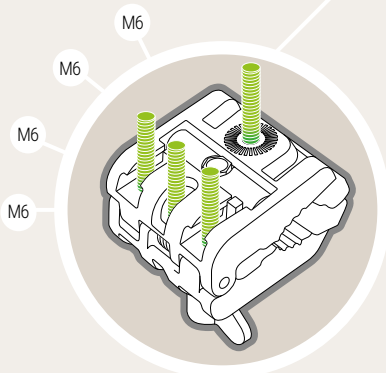



OWN MAKE & DESIGN MADE IN SPAIN  
 SAJÁT KÉSZÍTÉS ÉS TERVEZÉS,  
 SPANYOLORSZÁGBAN KÉSZÜLT  
 PRODUȚIE ȘI DESIGN PROPRIE,  
 FABRICAT ÎN SPANIA

**MULTICLAMPS**  
**MULTICLAMPS**  
**MULTICLAMPS**

PATENTED DESIGN  
 SZABADALMOZTATOTT FORMATERVEZÉS  
 DESIGN PATENTAT

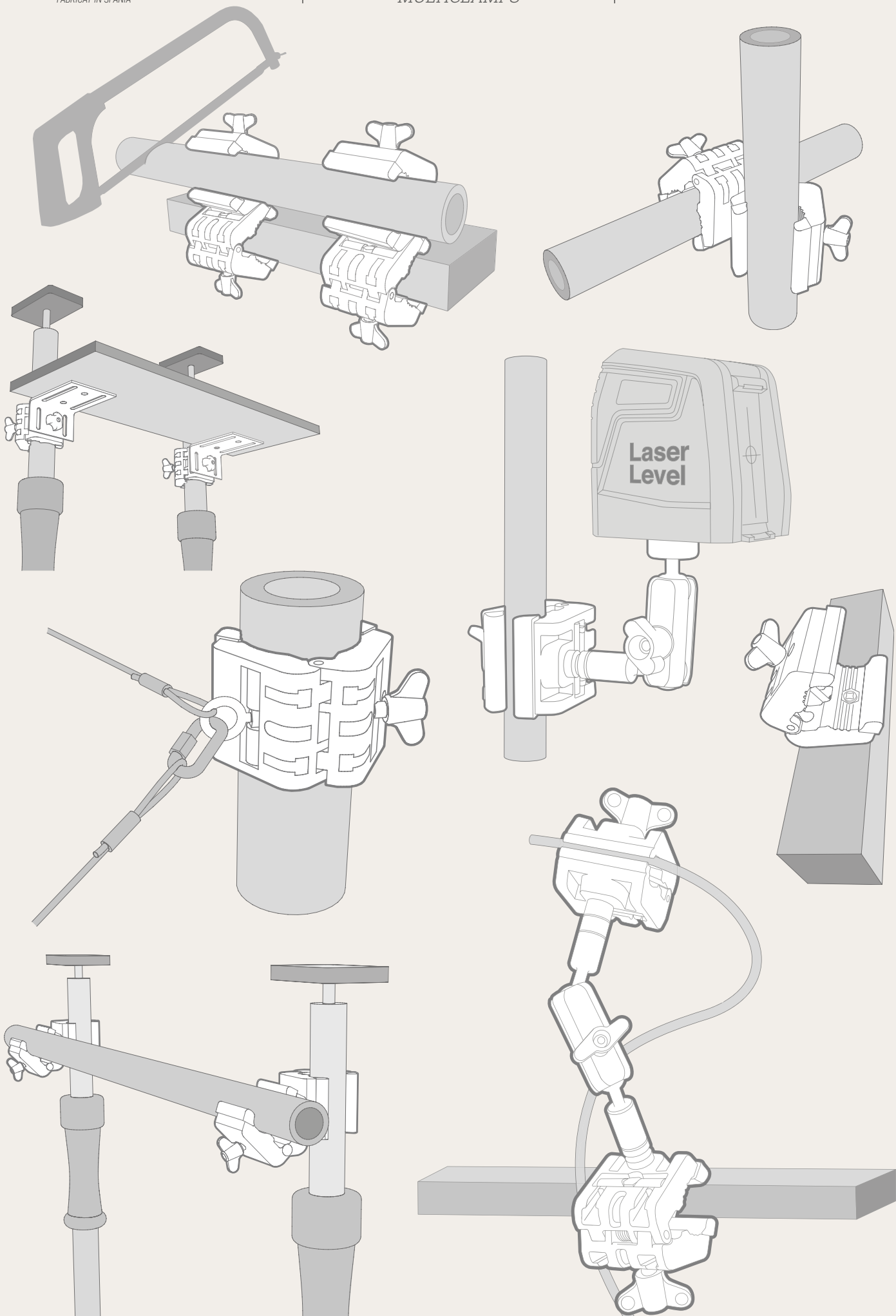



OWN MAKE & DESIGN MADE IN SPAIN  
SAJÁT KÉSZÍTÉS ÉS TERVEZÉS,  
SPANYOLORSZÁGBAN KÉSZÜLT  
PRODUCȚIE ȘI DESIGN PROPRIE,  
FABRICAT ÎN SPANIA

**MULTICLAMPS**  
**MULTICLAMPS**  
**MULTICLAMPS**

PATENTED DESIGN  
SZABADALMOZTATOTT FORMATERVEZÉS  
DESIGN PATENTAT



**MULTICLAMP**  
**MULTICLAMP**  
**MULTICLAMP**



COD	mm	mm	kg	
34052	50	18-48	0.22	1



**MULTICLAMP WITH HOOK**  
**MULTICLAMP NYITOTT SZEMŰ,**  
**HORGOS CSAVARRAL**  
**MULTICLAMP CU OCHI DESCHIȘI, CU**  
**ȘURUB CÂRLIG**



COD	mm	mm	kg	
34044	40	16-30	0.23	1



**MULTICLAMP WITH PRESSED EYE**  
**MULTICLAMP ZĂRTSZEMŰ CSAVARRAL**  
**MULTICLAMP CU ȘURUB ÎNCHIS**



COD	mm	mm	kg	
34046	40	18-48	0.23	1



**MULTICLAMP WITH ADJUSTABLE BASE • MULTICLAMP ÁLLÍTHATÓ ALJZATTAL • MULTICLAMP CU PRIZĂ REGLABILĂ**





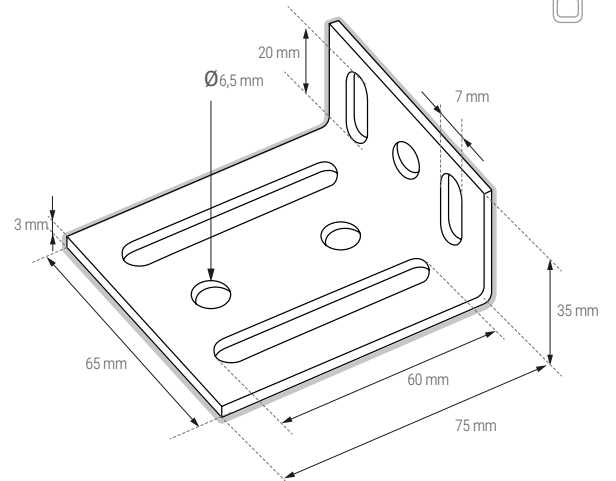

COD	mm	mm	kg	
34048	50	18-48	0.38	1



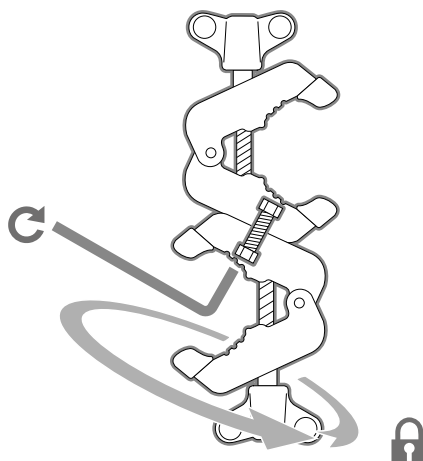

MULTICLAMP FIXED DOUBLE • MULTICLAMP FORGATHATÓ DUPLA FEJJEL • MULTICLAMP REGLABIL CU DOUĂ CAPETE





COD	 mm	 mm	kg	
34054	50	18-48	0.44	1

- Two Multiclamps connected using an M6 screw with an adjustable fixed 360° angle tightening the M6 screw.
- M6 csavarral egymáshoz rögzített két MULTICLAMP, amely a rögzítés tengelye körül 360°-ban elforgatható.
- Două MULTICLAMP fixate una de cealaltă cu un șurub M6, care pot fi rotite la 360° în jurul axei de fixare.

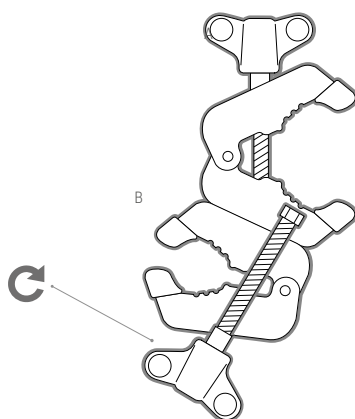
MULTICLAMP PIVOTING DOUBLE • MULTICLAMP DUPLA FEJJEL • MULTICLAMP DUBLA CU DOUA CAPETE





COD	 mm	 mm	kg	
34054	A: 50	A: 18-48	0.44	1
	B: 30	B: 18-30		

- Two Multiclamps connected through the threaded shaft of the pivoting clamp and with an adjustable 360° angle. NOUVEAU
- By turning up the wing nut you can easily adjust the pressure and the angle semi locking it
- Két MULTICLAMP menetes tengellyel rögzítve, amely lehetővé teszi az egyik fej rögzítését, valamint azt, hogy mindkettő fej 360° irányban elforgatható legyen.
- A csavar fellazításával egyszerűen megoldható a rögzítés, valamint a fej megfelelő pozícióba való forgatása.
- Fixat cu două axe filetate MULTICLAMP, care permit fixarea unei capete, precum și rotirea ambelor capete pe 360°.
- În timp ce desfacerea șurubului facilitează fixarea și rotirea capului în poziția corectă.

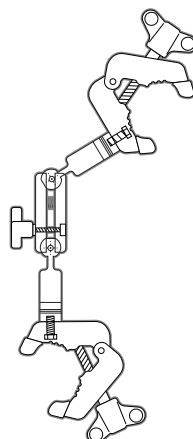
DOUBLE MULTICLAMP WITH ARTICULATED ARM • DUPLA MULTICLAMP CSUKLÓS KAROKKAL • MULTICLAMP DUBLU CU BRAȚE ARTICULATE



COD	 mm	 mm	kg	
34043	50	18-48	0.55	1

- Made of aluminium
- Multi-positionable with two joints.
- Easily fixed.
- Aluminiumból készült
- Több pozícióba állítható a két csukló által.
- Könnyen rögzíthető.
- Fabricat din aluminiu
- Poate fi reglat în mai multe poziții prin cele două articulații.
- Se poate fixa ușor.

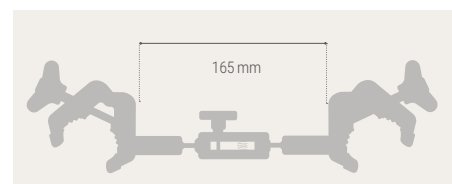





**MULTI-DEVICE SUPPORT • MULTICLAMP UNIVERZÁLIS KONZOL • CONSOLĂ UNIVERSALĂ MULTICLAMP**



**AL**

Made of Aluminium  
Aluminiumból készült  
Fabricat din aluminiu

COD	 mm	 mm	kg	
34061	50	18-48	0.42	1



- Aluminium arm.
- Multi-positionable with two joints.
- Easily fixed.
- UNC 1/4 Thread
- 3/8 y 5/8 Thread Adaptor
- Holding capacity 3 kg (6,61 lbs)..
- For lasers, cameras, levels, etc.

- Alumíniúm kar.
- Több pozícióba állítható a két csukó által.
- Könnyen rögzíthető.
- UNC 1/4 menetes csatlakozás
- 3/8" és 5/8" menetes adapter
- Teherbírás 3 kg (6,61 lbs).
- Lézerekhez, fényképezőgépekhez, vízszintezőkhöz stb.

- Braț din aluminiu.
- Reglabil în mai multe poziții, cu două îmbinări.
- Ușor de fixat.
- Conexiune filet UNC 1/4
- Adaptor cu filet de 3/8" și 5/8"
- Capacitate de încărcare 3 kg (6,61 lbs).
- Pentru lasere, aparate foto, nivele de apă etc.

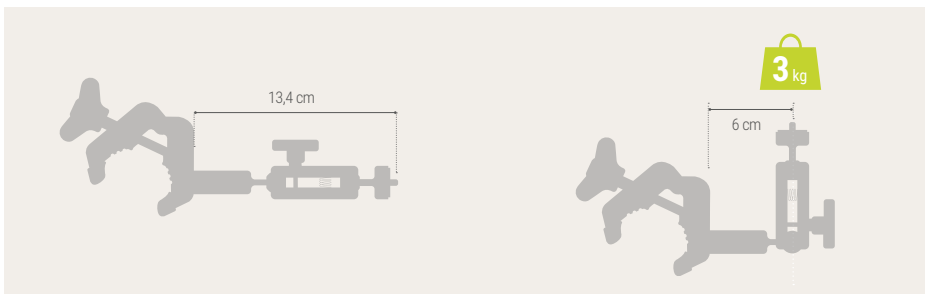
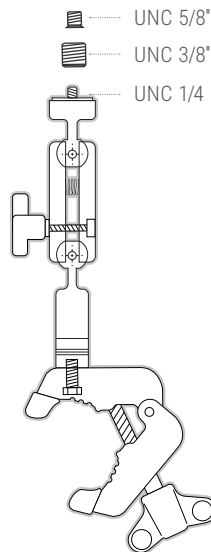

**EXTENSION ACCESSORY • HOSSZTOLDÓ ADAPTER • DISPOZITIV DE PRELUNGIRE**

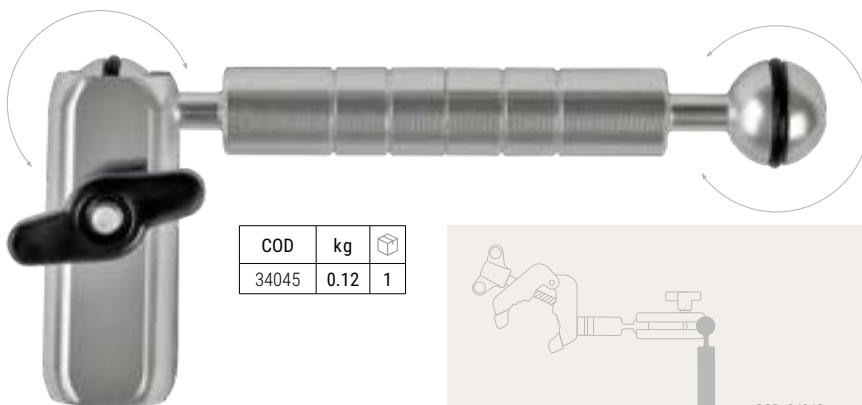

COD	kg	
34045	0.12	1

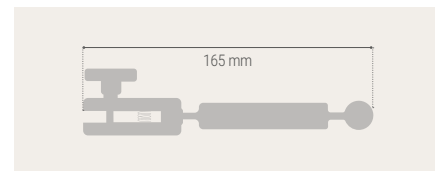

**AL**

Made of Aluminium  
Aluminiumból készült  
Fabricat din aluminiu

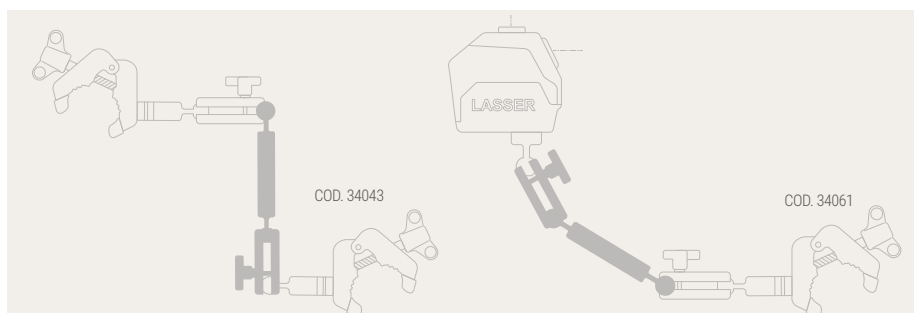

**BALL ACCESSORY UNC 1/4" • GÖMBVÉGŰ CSATLAKOZÓ ADAPTER UNC 1/4"**  
• ADAPTATOR CU MÂNECĂ ÎN FORMĂ DE BOL CU UNC 1/4"



- Made of aluminium.
- Standard UNC 1/4 screw
- Alumíniumból készült.
- Hagyományos UNC 1/4" csatlakozás
- Fabricat din aluminiu.
- Conexiune UNC tradițională de 1/4"

COD	kg	📦
34064	0,031	1



**THREAD ADAPTOR SET • MENETÁTALAKÍTÓ ADAPTER SZETT**  
• SET ADAPTOR FILET



- Made of brass to avoid damage to the device.
- A sérülések elkerülése érdekében rézből készült.
- Pentru a evita accidentările, este făcut din cupru.

COD	kg	📦
34059	0,025	1

2 unit-pack  
2 db/csomag  
2 buc/pachet



**MULTI-DEVICE SUPPORT WITH SUCTION CUP**  
UNIVERZÁLIS KONZOL VÁKUUMOS RÖGZÍTÉSSEL  
CONSOL UNIVERSAL CU FIXARE PRIN VACUUM

- Protection cap included.
- Horizontal suction capacity 25 kg
- Thread adaptors included
- Védőfedél tartozék.
- Vízszintes terhelhetőség 25 kg
- Menetes adapter tartozék.
- Capac de protecție inclusă.
- Capacitate de aspirație orizontală 25 kg
- Adaptori pentru filet incluși.



COD	Ø cm	Max. ↑	kg	📦
34058	11,5	25 kg	0,72	1

**MULTI-DEVICE SUPPORT WITH MAGNET**  
UNIVERZÁLIS KONZOL MÁGNESES RÖGZÍTÉSSEL  
CONSOL UNIVERSAL CU PRINDERE MAGNETICĂ

- Powerful permanent ferrite magnet.
- Thread adaptors included
- Erős ferrit mágnes.
- Menetes adapter tartozék.
- Magnet puternic.
- Adaptori pentru filet incluși.



COD	Ø cm	Max. ↑	kg	📦
34063	8,8	15 kg	0,62	1

**SMARTPHONE & TABLET HOLDER • TABLET ÉS OKOSTELEFON TARTÓK • SUPORT PENTRU SMARTPHONE ȘI TABLETĂ**

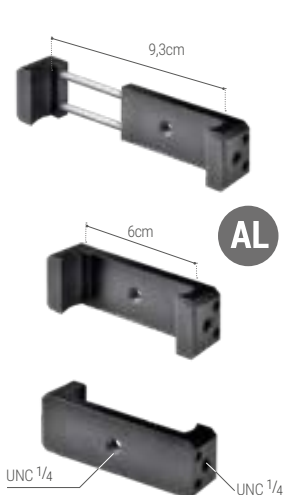

**AL** Made of Aluminium  
Alumíniumból készült  
Fabricat din aluminiu



COD	kg	📦
34056	0,038	1

COD	kg	📦
34057	0,15	1

- Rubber protection on contact surfaces.
- Double spring mechanism for clamping.
- Side and rear nuts for fastening.
- Gumival borított érintkező felületek.
- Kettős rugós mechanizmus az összeszorításhoz.
- Oldalsó és hátsó anyák a rögzítéshez.
- Protecție din cauciuc pe suprafețele de contact.
- Mecanism cu arc dublu pentru prindere.
- Piulițe pentru fixare.

- Made of ABS plastic
- Rubber protection on contact surfaces.
- Brass nut for fastening
- ABS műanyagból készült
- Gumi védelem a kontaktfelületeken.
- Réz anya a rögzítéshez.
- Fabricat din plastic ABS
- Protecție din cauciuc pe suprafețele de contact.
- Piuliță din alamă pentru fixare.

