











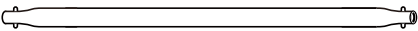
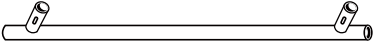

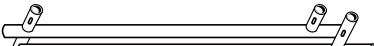
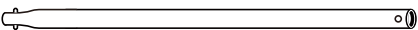

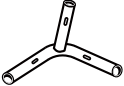
# Metal Walk-in Chicken Coop Run

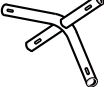
Instruction manual  
For specification: 4m(L) x 4m(W) x 2m(H)

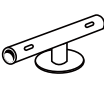

Please read this manual carefully before assembly

# Part List For Chicken Run

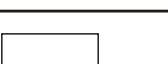
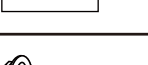
Part No.	Size(mm)	Picture	4x4x2m
②	1870		20
③	970		6
⑤	440		2
⑥	530		1
D1			1
D2			1
D3			1
⑩	1870		2
A1			4
A2			2
B1			2
B2			1
C			4
D			2
E			2
L			2
F			1
G			9
H			6
I			3
J			1
K			6
			10

# CHICKEN RUN 4X4X2m

## Step 1

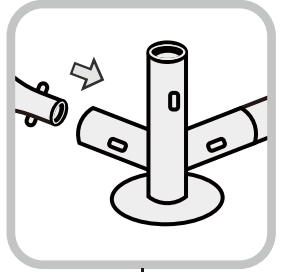
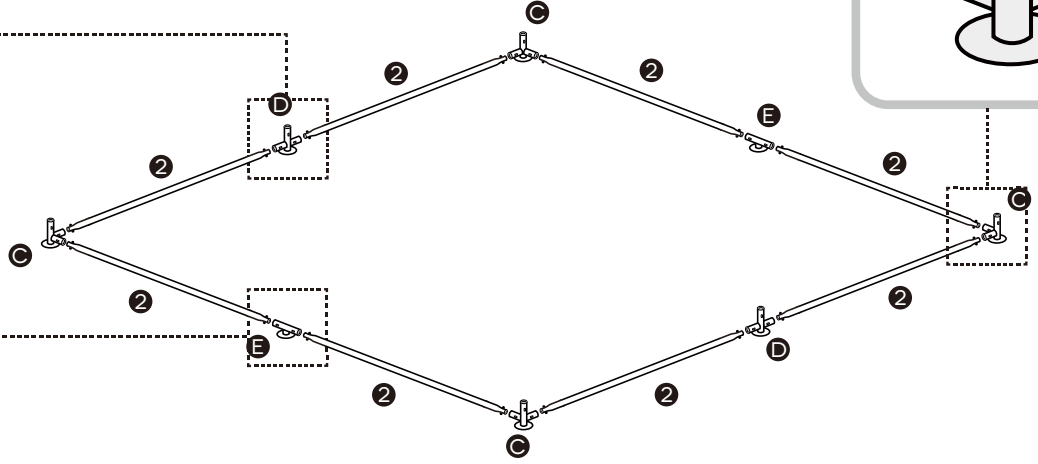
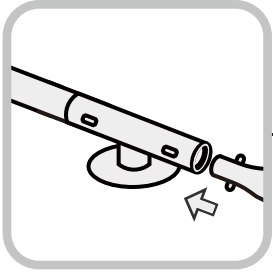
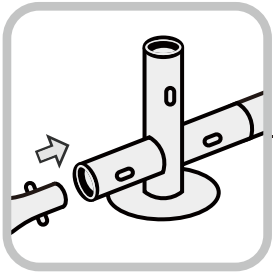

## Step 2

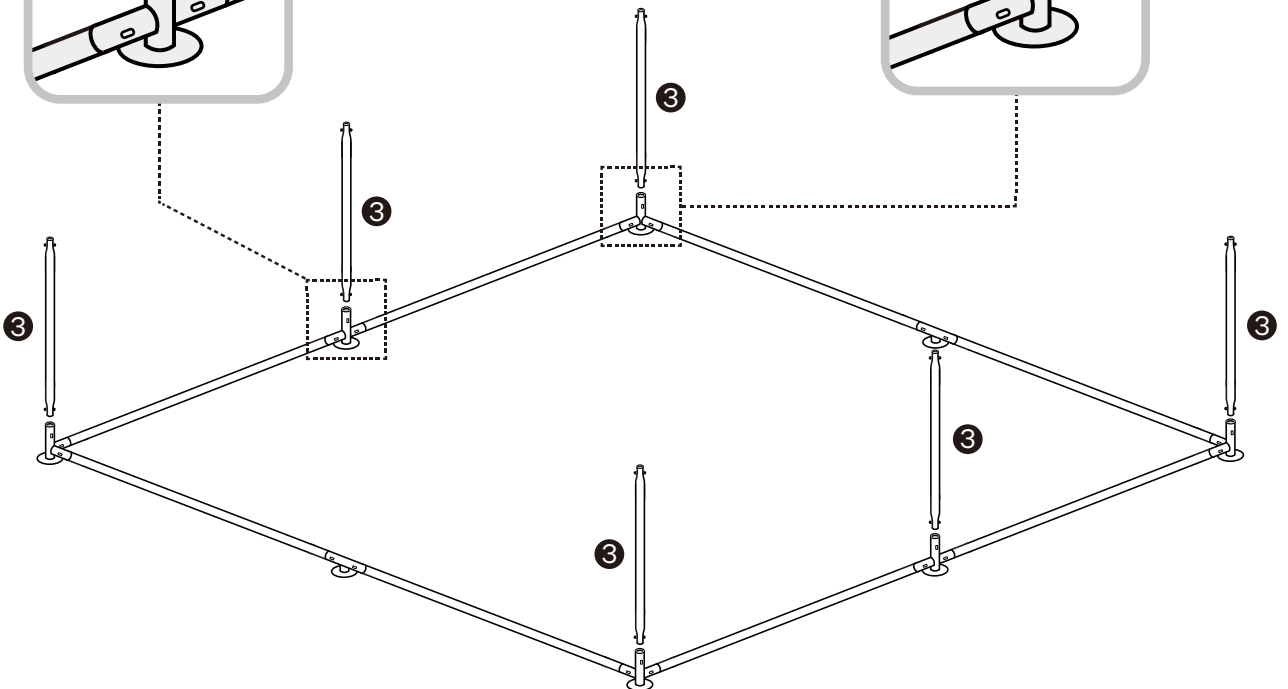
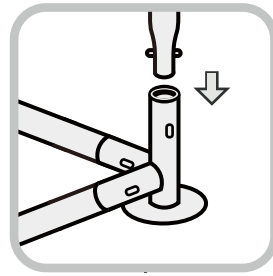
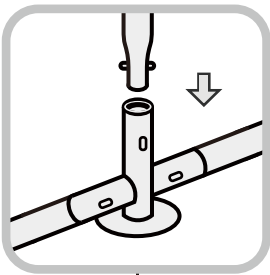

### Step 3

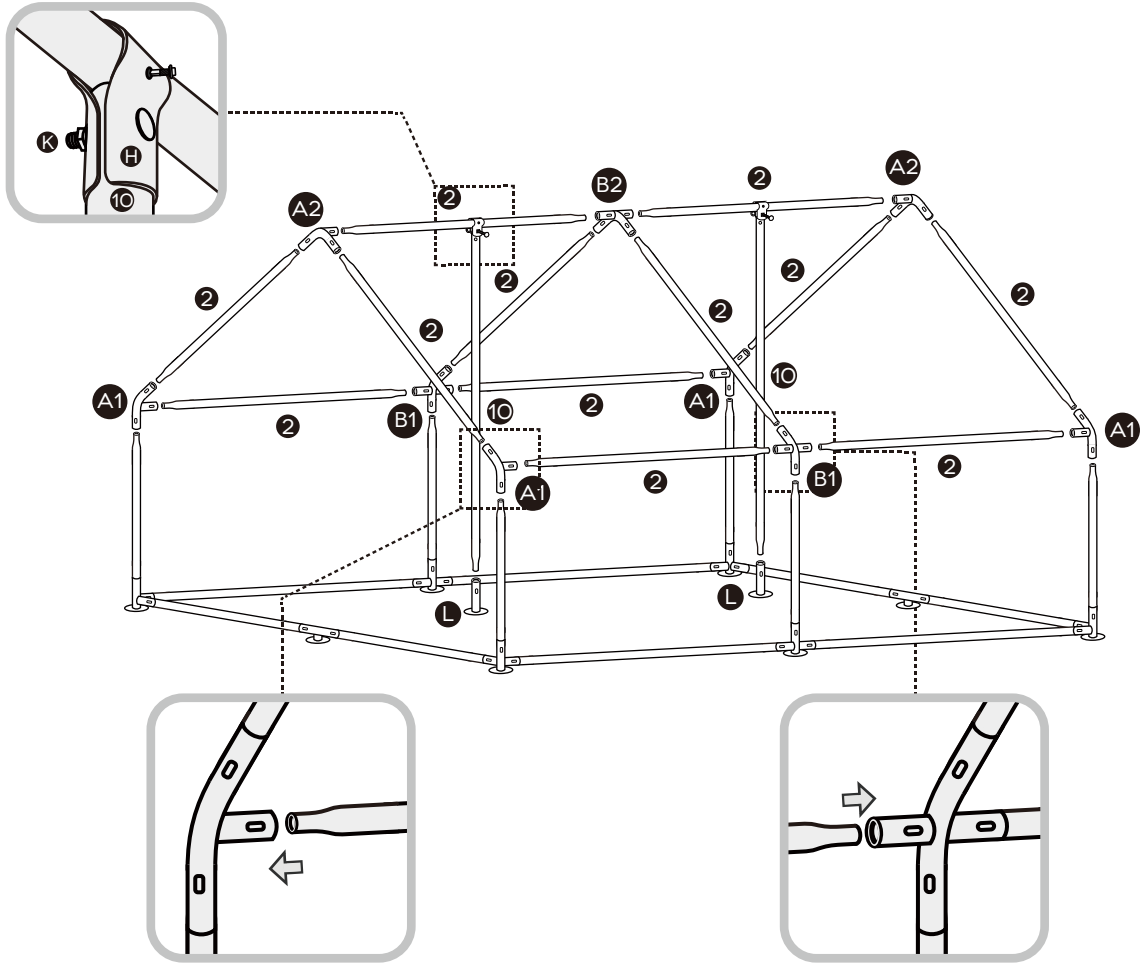

### Step 4

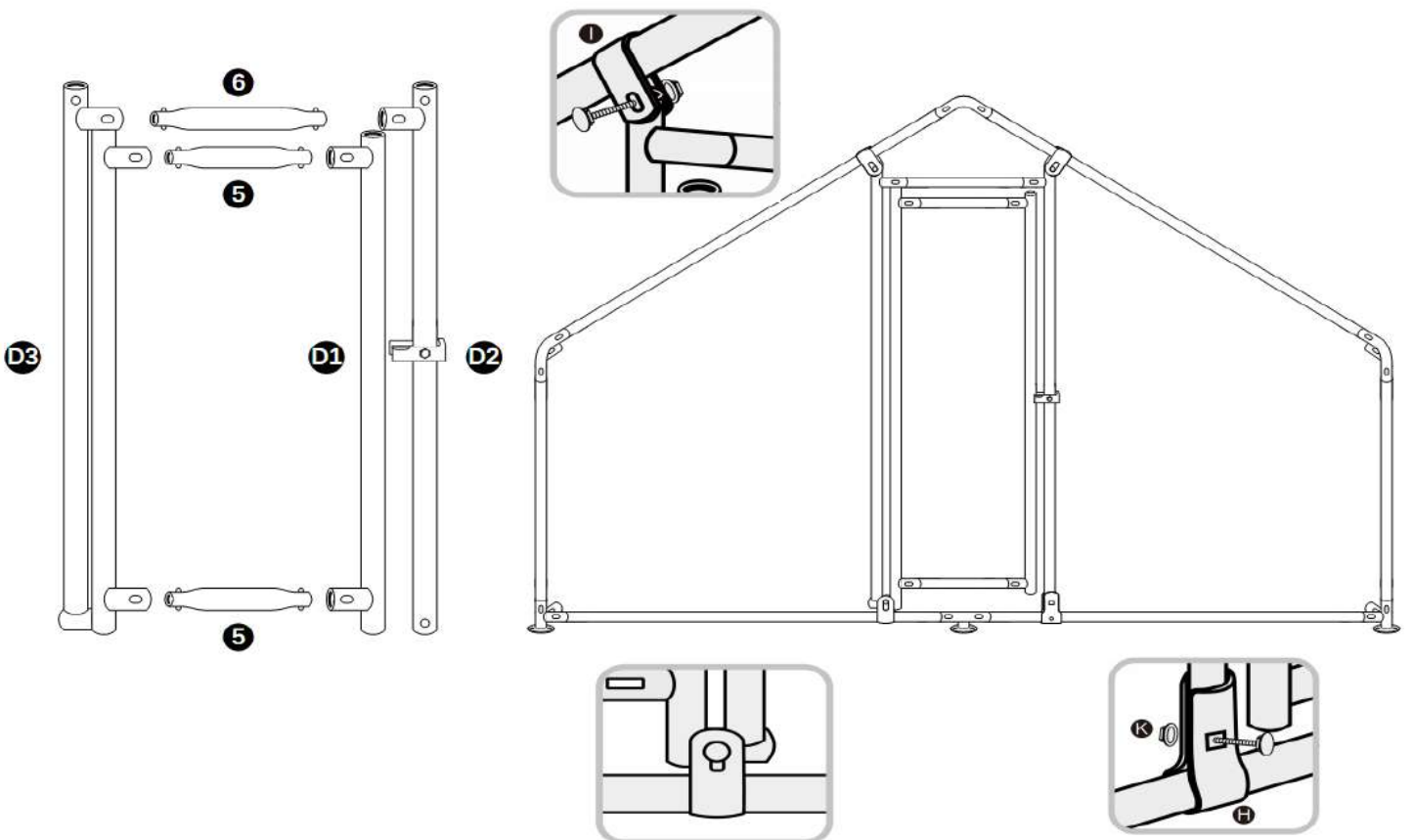

**Step 5: NO PRE-CUT!**  
Cover around the house, then cut off finally

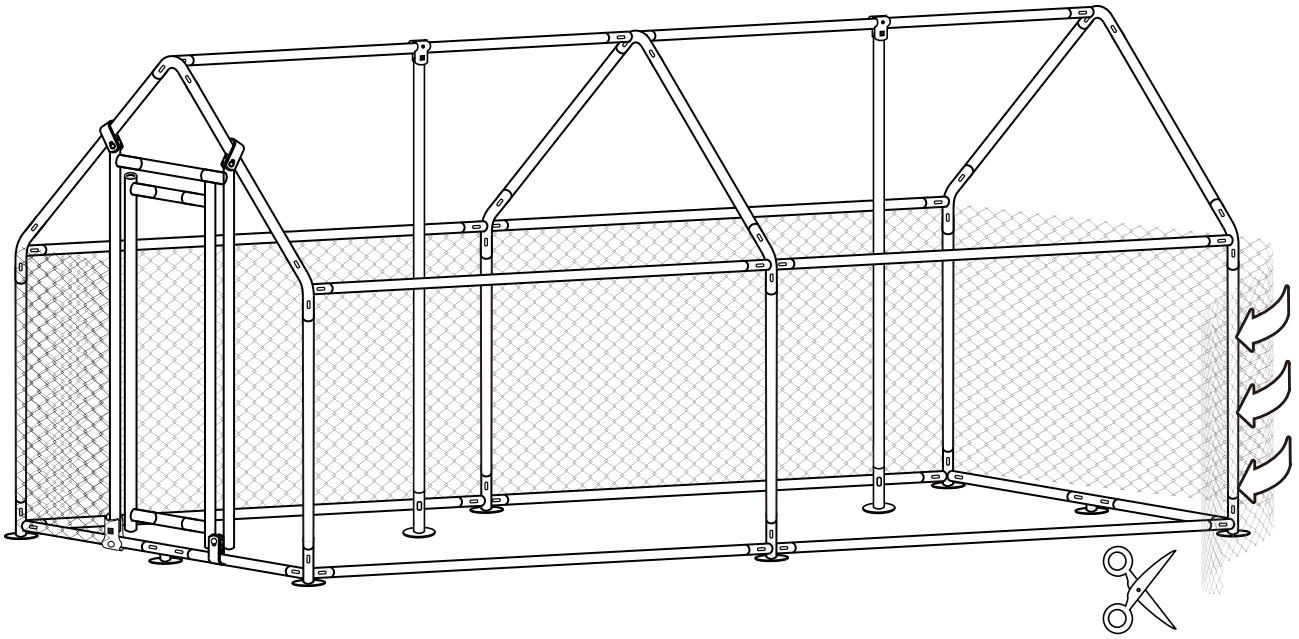

**Step 6: NO PRE-CUT!**  
Cover the top, finally cut off

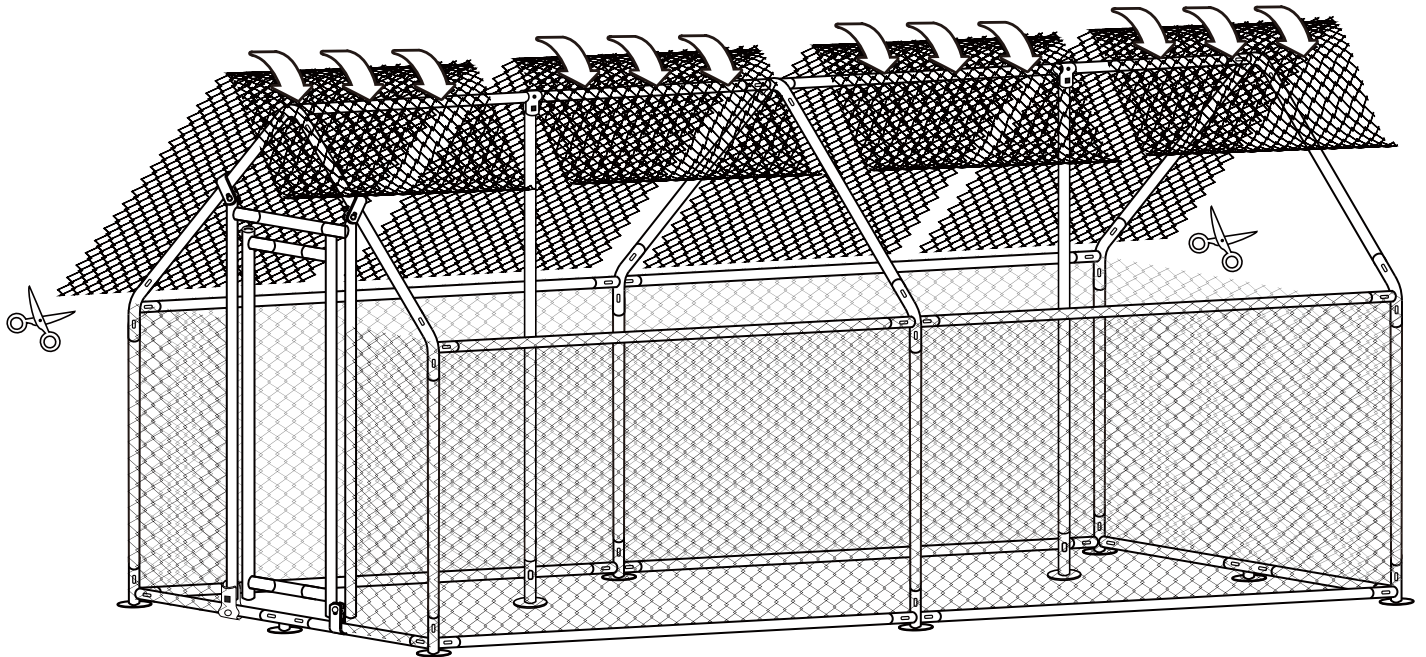

**Step 7:** Measure the  $\Delta$  parts of front and back sides,  
Pre-cut the wire mesh for covering

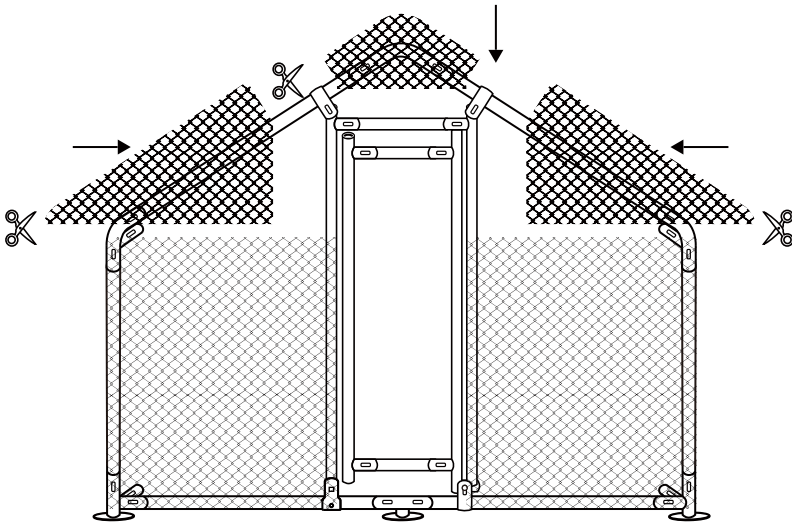

(Front)

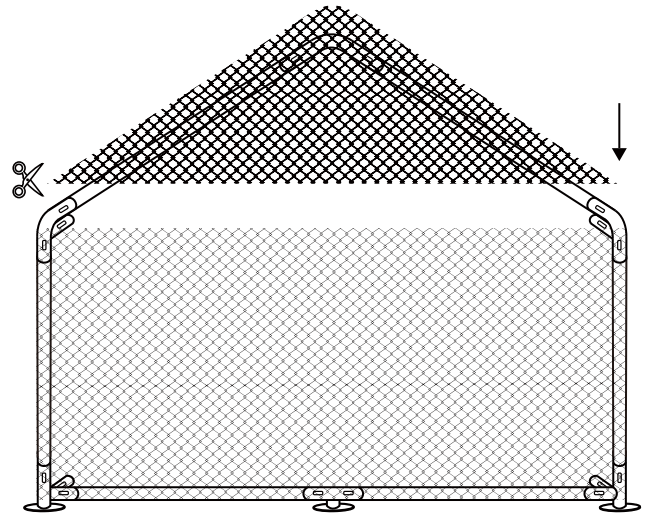

(Back)

**Step 8:** Measure the door size  
Pre-cut the wire mesh for covering

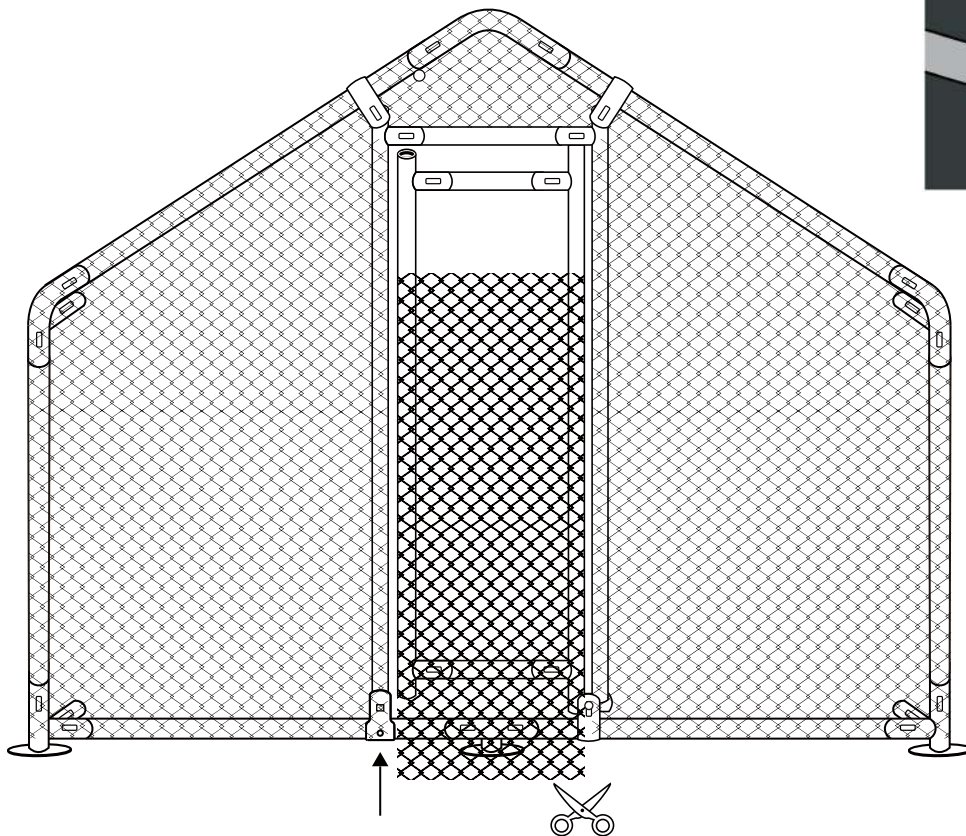

## Step 9

Put the waterproof cover "J" on the frame, tighten it on the frame with.

