











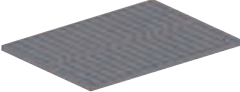

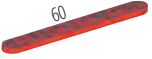

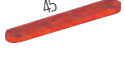
CONSTRUIESTE SI JOACA - JOC DE MASA

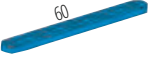
INSTRUCTIUNI DE ASAMBLARE

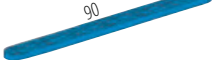
	32 881 2x		36 922 2x		122 950 2x
	32 985 1x		36 950 6x		139 646 2x
	36 293 2x		37 468 12x		173 044 1x
	36 323 22x		38 236 12x		173 573 4x
	36 324 2x		38 240 4x		173 574 4x
	36 920 4x		38 246 2x		
	36 921 6x		38 263 12x		

**TOATE COMPONENTELE, IN SPECIAL
CELE MOBILE TREBUIE CURATATE
DUPA FIECARE UTILIZARE.**



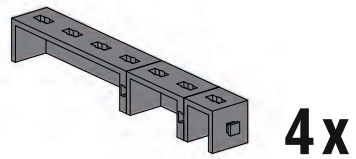
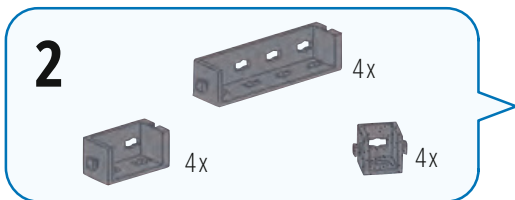
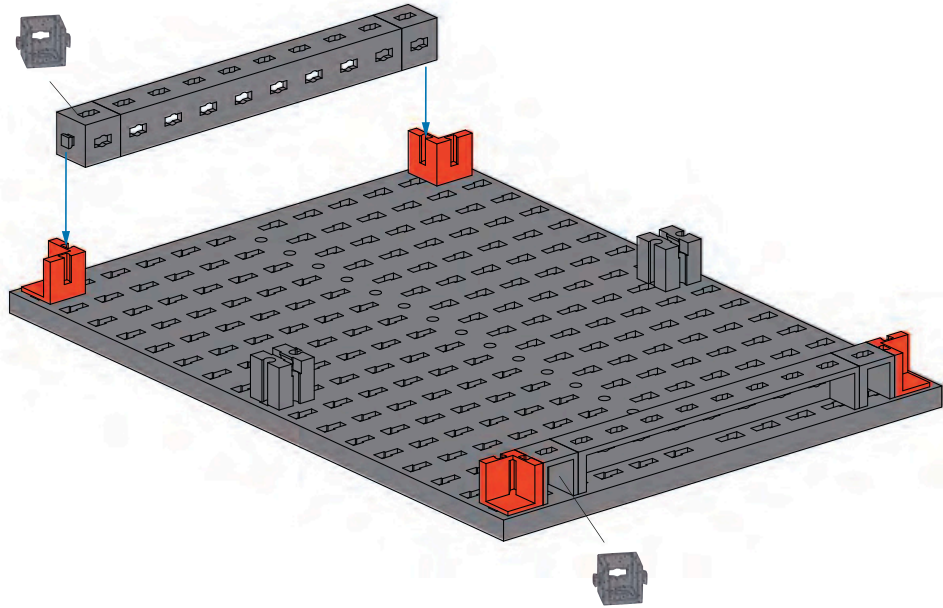
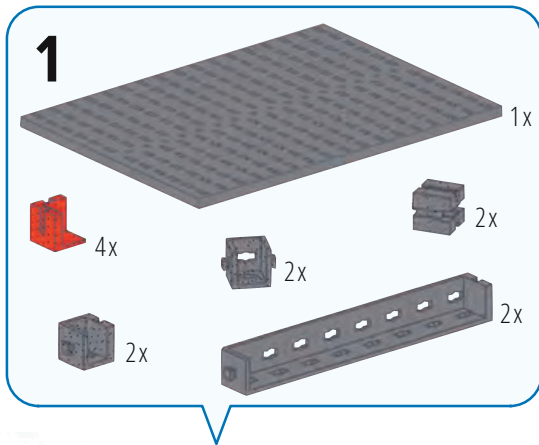
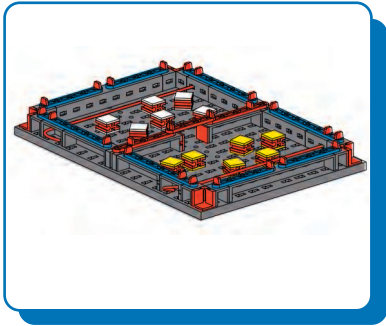

www.fischertechnik.de/FanClub

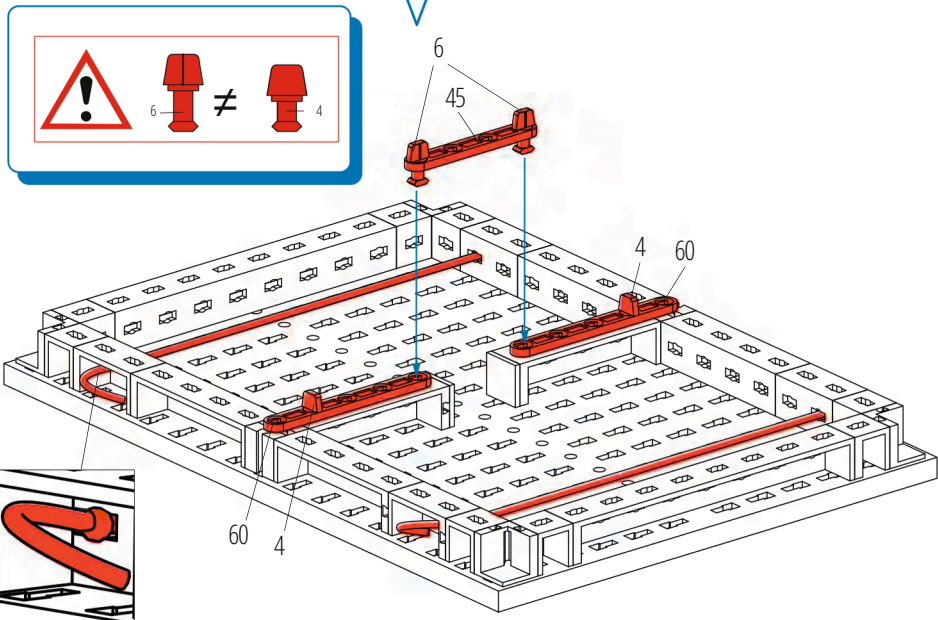
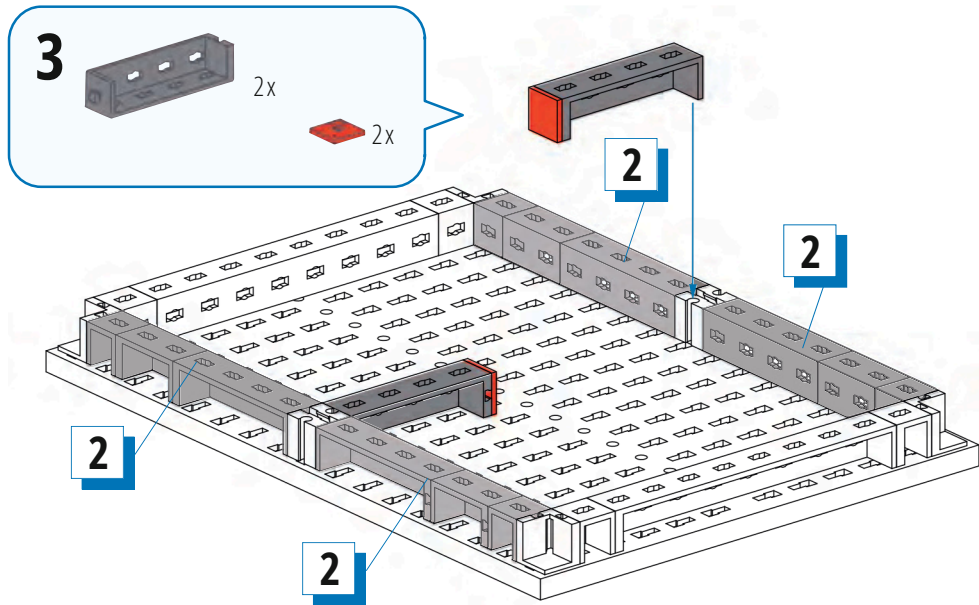

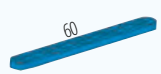
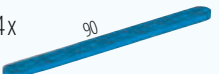

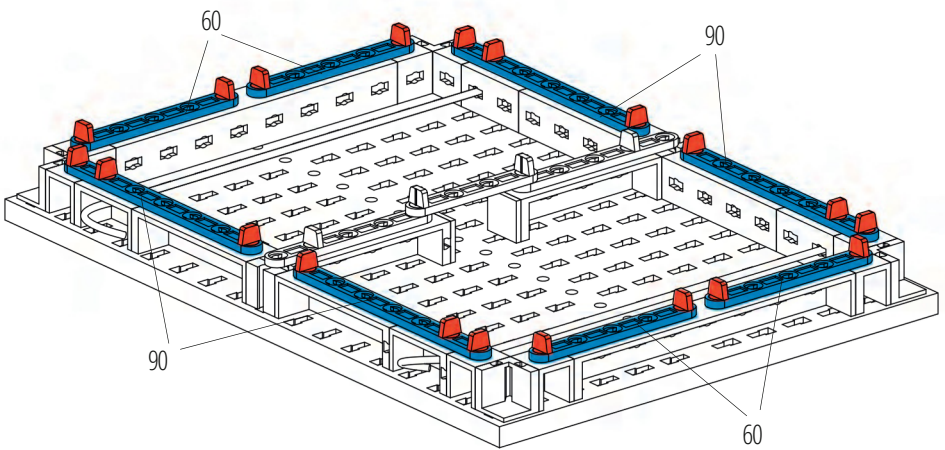

5  4 20x  4x  4x



6  6x  12x



7  6x  12x



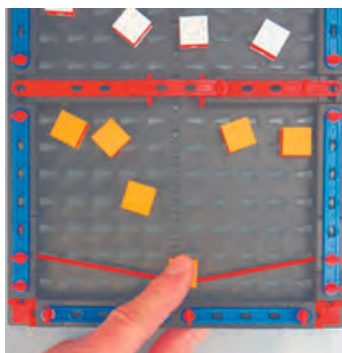

<https://www.fischertechnik.de/slide-battle>

Instrucțiuni de joc

Odată ce ați configurat modelul, sunteți gata. Puteți juca jocul în diferite variante. Acestea sunt explicate mai jos:

Scopul jocului

Acest joc se joacă în perechi. Scopul jocului este să vă ștergeți propria tablă înainte ca adversarul să o șteargă pe a lui.

Jocul 1: versiunea clasică

Fiecare jucător primește șase piese, care sunt așezate pe partea sa de tablă. Numărând până la trei, încercați să trageți piesele de pe partea dvs. pe partea adversarului cât mai repede posibil folosind poarta.

Pentru a trage: luați o bucată, așezați-o pe banda de cauciuc, trageți piesa spre dvs. cu banda de cauciuc și apoi eliberați-o. Tensiunea benzii de cauciuc face ca piesa să tragă înainte. Asigurați-vă că scopul dvs. este precis, astfel încât piesele dvs. să treacă prin obiectiv. De îndată ce partea ta este goală și toate piesele sunt în partea adversarului tău, ai câștigat. J

Jocul 2: Turneul

Dacă sunteți mai mult de doi jucători, puteți organiza un turneu mare. Formați întotdeauna echipe de câte doi pentru a concura unul împotriva celuilalt. Câștigătorii din prima rundă concurează unul împotriva celuilalt în runda următoare. Continuați să jucați până când rămâne un singur jucător

