



HAPPY VA

**BENINCA****100%**
Made in Italy

TRANSMITTERS WITH DOUBLE CODING, ADVANCED ROLLING CODE AND ROLLING CODE

2 and 4 channels



Configuration and list of available channels (ARC only):

	CH1		CH5
	CH2		CH6
	CH3		CH7
	CH4		CH8
	hidden button		CH9

- 2 or 4-channel transmitter with double coding, Advanced Rolling Code and Rolling Code, with green interchangeable cover with soft lines and essential design
- The new ARC coding guarantees maximum security due to the length of the transmitted code (128 bit) and the high number of possible combinations
- The transmitter has ARC coding as factory setting. However, it is possible to change the coding by using it in Rolling Code or even in mixed coding (ARC and Rolling Code)
- If using mixed coding, the ARC can be set with the T1/T3 buttons and the Rolling Code with the T2/T4 buttons
- The HAPPY.4VA model allows users to set up to 9 channels, thanks to the option of activating the command by simultaneously pressing two buttons chosen by the user. This function allows avoiding accidental openings caused by pressing a button by mistake and is particularly indicated for use with alarm systems
- Covers in three different colours are available as accessories, respectively for the version with 2 or 4 channels (FLIP.2/FLIP.4)
- Easy access to the battery and to the transmitter type, located on the front under the coloured cover

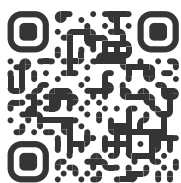

Training

Guide to change coding and the use of mixed coding with HAPPY.VA transmitters. Watch the video.

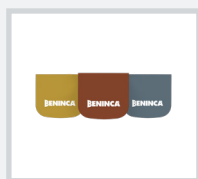
**FLIP.2**

Package of 2-channel covers for HAPPY transmitters. Contains 10 pieces for each available colour: orange, light blue and yellow. **Package of 30 pcs.**

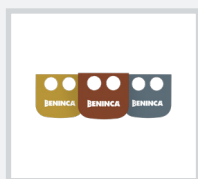
**FLIP.4**

Package of 4-channel covers for HAPPY transmitters. Contains 10 pieces for each available colour: orange, light blue and yellow. **Package of 30 pcs.**

**ONE.2WO**

433.92 MHz receiver with power supply 12÷28 VDC / 21÷28 VAC, 2 channels with triple coding: Advanced Rolling Code, Rolling Code and Fixed Code, with outdoor IP54 box. 512 memorisable codes.

**ONE.2WB**

433.92 MHz receiver with power supply 12÷28 VDC / 21÷28 VAC, 2 channels with triple coding: Advanced Rolling Code and Rolling Code, in box. 512 memorisable codes.

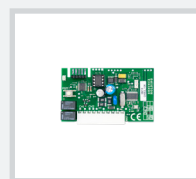
**ONE.2WI**

433.92 MHz receiver with power supply 12÷28 VDC / 21÷28 VAC, 2 channels with triple coding: Advanced Rolling Code and Rolling Code, plug-in. 512 memorisable codes.

**ONE.4WB**

4-channel receiver with full-range power supply (115-230 VAC/DC) and triple coding: Advanced Rolling Code, Rolling Code and Fixed Code, with outdoor IP54 box. 512 memorisable codes.



HAPPY.2VA

2-channel transmitter with Advanced Rolling Code and Rolling Code.



HAPPY.4VA

4-channel transmitter with Advanced Rolling Code and Rolling Code.

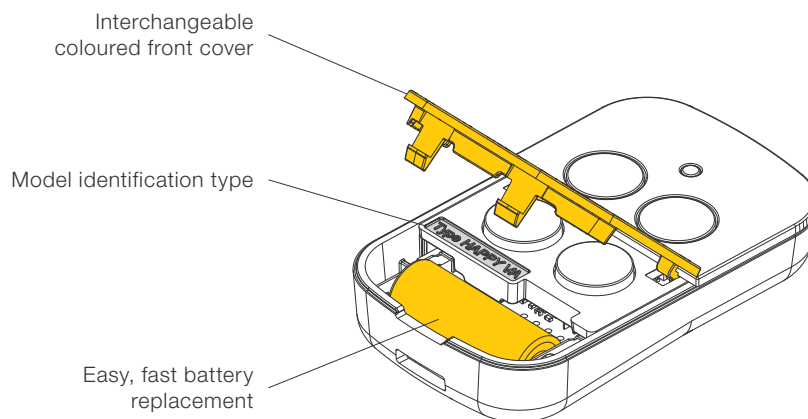

AUTOMATISMI BENINCÀ SpA • Via del Capitello, 45 • 36066 Sandrigo (VI) ITALY • T +39 0444 751030 • sales@beninca.com



CALL

Four-channel GSM receiver, up to 4 automations control without limits of distance. Makes it possible to use the device by means of a mobile telephone.

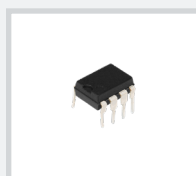

MEM2048

Additional memory for up to 2048 codes. For receivers of the ONE series.

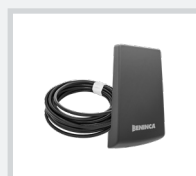

AWO

433.92 MHz antenna for external installation with IP54 box, fitted with shielded RG58 5 m cable.

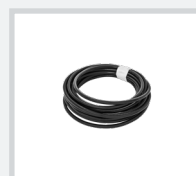

RG58 MT5

AWO antenna cable L = 5 m.

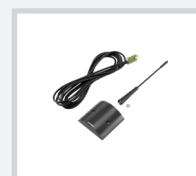

AW

433.92 MHz stylus antenna for external installation, equipped with a shielded 3m RG58 cable.



BT12

12 V Battery, for transmitter. Available in 50 pcs packing.