

Q80S

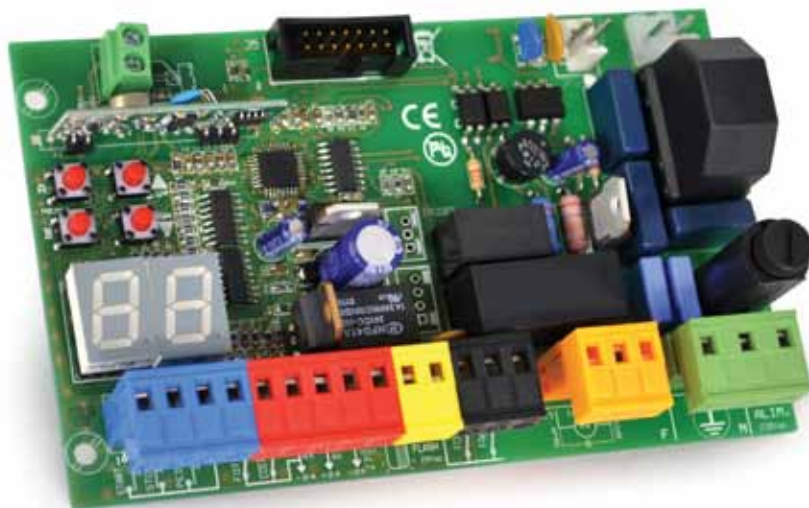

Multi-function control panel for sliding gate - 230Vac

- Programming display
- Electronic adjustment of working time
- Automatic programming procedure with obstacle detection (anti-crushing function) or step-by-step programming procedure with electronic adjustment of power and deceleration.
- "Quick closing" function
- Pedestrian Opening function
- Multi-Occupation function.
- Pre-Blinking function.
- Additional radio channel (optional module)
- Built-in radio receiver 433,92MHz (64 codes) suitable for standard fix-code transmitters or rolling-code transmitters
- Terminal for safety edge 8K2 type
- Fault Diagnostic with display messages

TECHNICAL FEATURES

Item code	PQ80S
Control Panel Dimensions	137 x 84 x 37 mm
Box dimensions	220 x 290 x 90 mm
Control Panel Weight	160 g
Main Power	230V ~ 50-60Hz
Main Power Tolerance	-10% +20%
Transformer	230/21Vac – 15VA
Main Fuse	5 A
Rated power input	600 W
Rated current	3.5 A
Current in stand-by mode	30 Ma
Blinker power supply	24 Vac, max 20 W
Accessories power supply	24 Vdc , max 5 W
Working temperature	-20 +50 °C

Index

1.	WARNINGS	<i>pag. 02</i>
2.	WIRING DIAGRAM AND COMPONENTS	<i>pag. 03</i>
3.	ELECTRIC WIRINGS	<i>pag. 04</i>
3.1	MOTORS wiring	<i>pag. 06</i>
3.2	MAINS wiring	<i>pag. 07</i>
3.3	START controls wiring	<i>pag. 07</i>
3.3.1	TIMER wiring	
3.3.2	KEY-SWITCH wiring	
3.4	PEDESTRIAN START controls wiring	<i>pag. 07</i>
3.5	STOP push-button wiring	<i>pag. 08</i>
3.6	PHOTOCELLS wiring	<i>pag. 08</i>
3.6.1	CLOSING Photocells wiring	
3.6.2	OPENING Photocells wiring	
3.7	SAFETY EDGE wiring	<i>pag. 09</i>
3.7.1	CLOSING Safety Edge	
3.7.2	OPENING Safety Edge	
3.7.3	CLOSING Safety Edge 8K2	<i>pag. 10</i>
3.7.4	OPENING Safety Edge 8K2	
3.8	BLINKER wiring	<i>pag. 11</i>
3.9	AUX/2nd RADIO CHANNEL module	<i>pag. 11</i>
3.9.1	2nd RADIO CHANNEL settings	<i>pag. 11</i>
3.9.2	CONTROL LIGHT settings	
3.9.3	COURTESY LIGHT settings	
4.	PROGRAMMING	<i>pag. 12</i>
4.1	Menu RADIO	<i>pag. 12</i>
4.2	PROGRAMMING menu	<i>pag. 14</i>
4.2.1	Selecting the PROGRAMMING MODE AUTOMATIC programming mode, with OBSTACLE DETECTION SEQUENTIAL programming mode	<i>pag. 15</i>
4.2.2	Restoring DEFAULT SETTINGS	<i>pag. 15</i>
4.2.3	OPENING DIRECTION of the motor	<i>pag. 16</i>
opening direction of the motor can be changes as follows		
4.3	FORCE menu	<i>pag. 17</i>
TORQUE/POWER adjustment		
OBSTACLE DETECTION adjustment	<i>pag. 18</i>	
4.4	FUNCTIONS menu	<i>pag. 18</i>
MULTI-OCCUPATION		
PRE-BLINKIN		
DECELERATION	<i>pag. 19</i>	
PHOTOCELLS TEST		
START PULSE		
QUICK CLOSING	<i>pag. 20</i>	
SEPARATE PUSH-BUTTONS		
MOTORS TEST		
FLASHING LIGHT mode	<i>pag. 23</i>	
DEAD MAN'S SWITCH Mode		
4.5	TIMES menu	<i>pag. 22</i>
AUTOMATIC CLOSING pause time		
PEDESTRIAN CLOSING pause time		
OPERATING time		
DECELERATION time	<i>pag. 23</i>	
PEDESTRIAN OPENING time		
4.6	ACCESSORIES menu	<i>pag. 24</i>
EMERGENCY STOP terminals		
CLOSING PHOTOCELLS terminals		
OPENING PHOTOCELLS/SAFETY EDGE terminals		
5.	TROUBLE-SHOOTING	<i>pag. 25</i>
6.	DISPOSAL	<i>pag. 35</i>
ANNEX 1	Table for PROGRAMMING	
ANNEX 2	CE Declaration	

1. WARNINGS

WARNING: This manual contains important information concerning personal safety. An incorrect installation or an improper use may lead to severe injuries.

Read carefully and pay particular attention to the safety sections marked by the symbol .

Store this manual safely for future use.

 **Do not allow children or pets near your gate. Never let children operate or play with gate controls. Keep the remote controls away from children and unauthorised users.**

 **All wirings or operations on the control panel must be performed with the control panel disconnected from the power supply.**

 **Connect the control panel only to a power supply line equipped with safety grounding system.**

Wiring, settings and commissioning of this control board must be carried out by qualified and experienced personnel only. The installation has to comply to laws and regulations in force, with particular reference to EN 12445 provisions.

This appliance is only to be used with the power supply unit provided with the appliance.

Means for disconnections must be incorporated in the fixed wiring in accordance with the wiring rules and wiring diagram (please see paragraph 3).

When operating a biased-off switch, make sure that other persons are kept away.



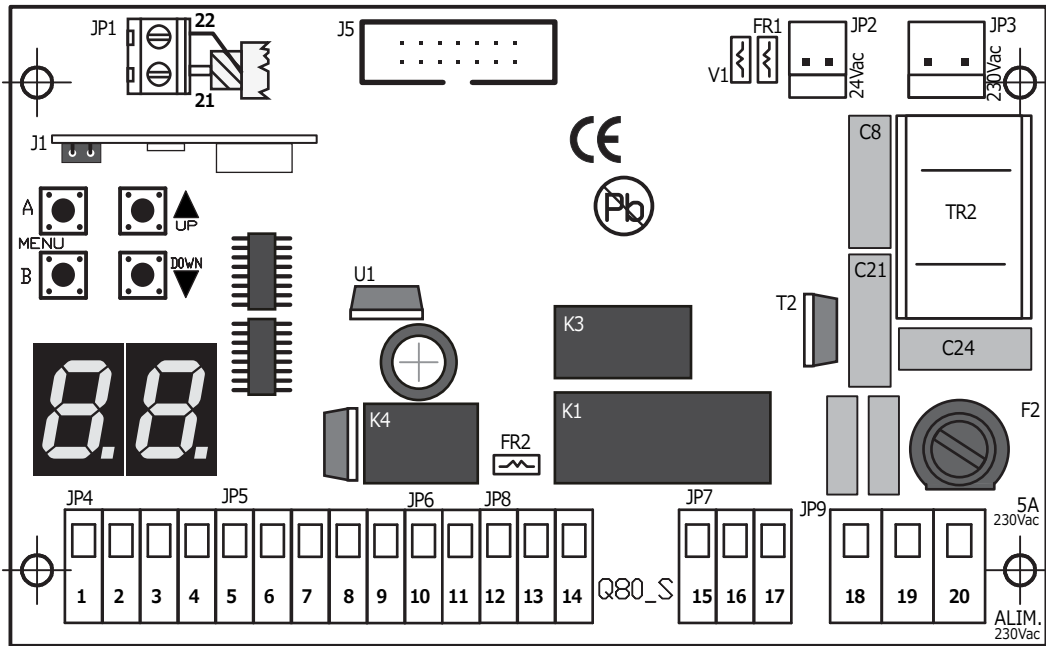

Frequently examine the installation for signs of wear or damage to cables. Do not use if repair or adjustment is needed.

2. WIRING DIAGRAM and COMPONENTS



- DISPLAY** = segments display
J1 = radio module
J5 = plug for optional modules
F2 = 230V fuse 5A
FR1 = 24V fuse 1.6A (self-restorable)
FR2 = 24V fuse 0.6A (self-restorable)
V1 = secondary varistor
K1/K3 = motor relay
K4 = blinker relay
TR2 = filter
- JP1** = AERIAL terminal block
JP2 = secondary transformer plug 24Vac
JP3 = main transformer plug 230Vac
JP4 = CONTROLS terminal block
JP5 = PHOTOCELLS terminal block
JP6 = BLINKER terminal block
JP7 = input Motor
JP8 = input LIMIT-SWITCH
JP9 = 230V MAIN power/earth terminal block

Display BUTTONS Legend

A 	ENTER
B 	EXIT
	INCREASE or START command (when not programming)
	DECREASE or PEDESTRIAN START command (when not programming)

3. ELECTRIC WIRINGS

WIRING Diagram for **230Vac** motor

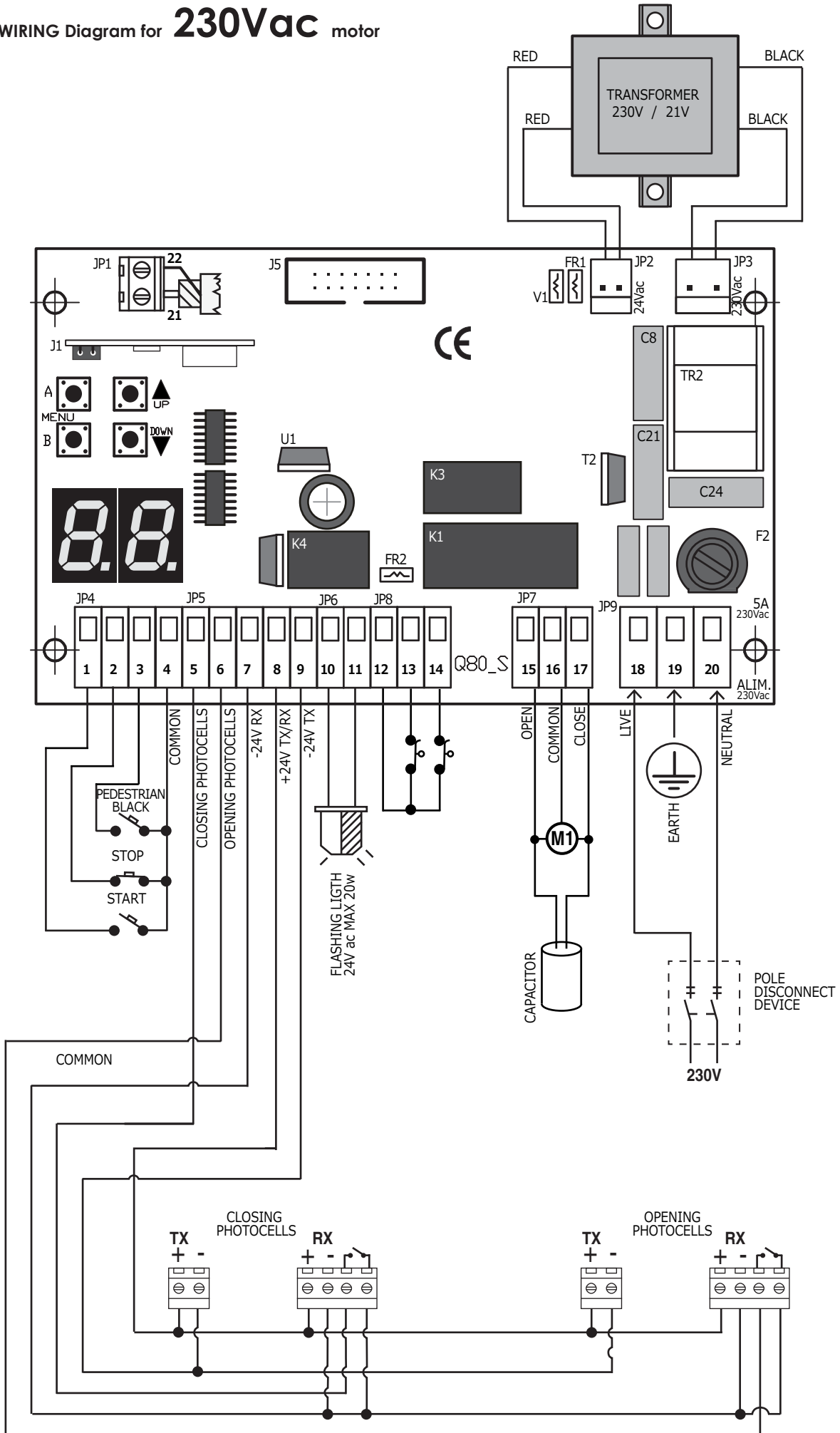

English

JP1 = AERIAL terminal block

- 21 aerial cable (SIGNAL)
- 22 aerial cable (EARTH)

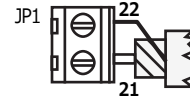

JP2 = TRANSFORMER secondary plug 24Vac (red wires)

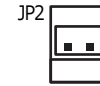

JP3 = TRANSFORMER main plug 230Vac (black wires)



JP4 = CONTROLS terminal block

- 1 START command (N.O. contact)
- 2 STOP command (N.C. contact)
- 3 PEDESTRIAN START command (N.O. contact)
- 4 NEUTRAL for controls

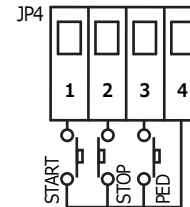

JP5 = PHOTOCELLS and SAFETY DEVICES

- 5 CLOSING PHOTOCELLS terminal (N.C. contact)
- 6 OPENING PHOTOCELLS terminal (N.C. contact)
- 7 Photocells RECEIVER power supply -24V
- 8 Photocells RECEIVER/TRANSMITTER
- 9 Photocell TRANSMITTER power supply -24V

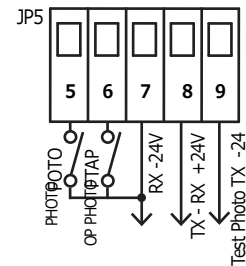

JP6 = BLINKER terminal block

- 10 BLINKER power supply 24Vac
- 11 BLINKER power supply 24Vac

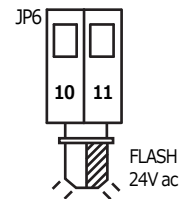

JP7 = MOTOR terminal block

- 15 OPENING LIMIT-SWITCH
 - 16 NEUTRAL
 - 17 CLOSING LIMIT-SWITCH
- } terminal MOTOR M1

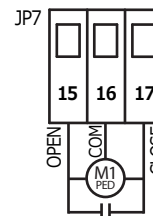

JP8 = LIMIT-SWITCH terminal block

- 12 NEUTRAL-
- 13 OPENING LIMIT-SWITCH
- 14 CLOSING LIMIT-SWITCH

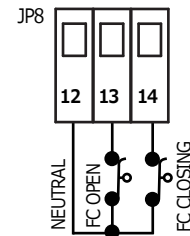

JP9 = 230V MAIN POWER/EARTH terminal block

Pole disconnect means must be incorporated in the fixed wiring to the control panel

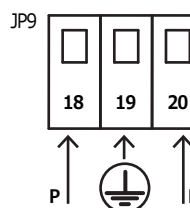

J5 = plug for optional modules



3.1 MOTORS wiring

Please check motor wirings according to the gate opening direction

Gate opening from left to RIGHT (view from inside courtyard)

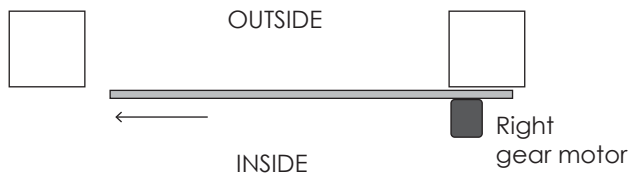

The control unit is pre-set for gate opening from left to right (looking from inside the courtyard as shown in the drawing).

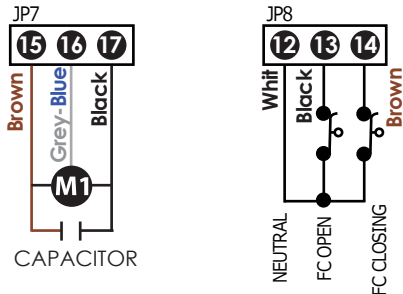

Gate opening from right to LEFT (view from inside property)

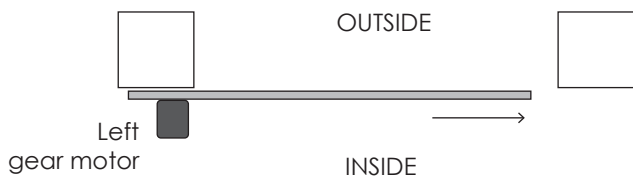

In case of gate opening from right to left please adjust parameter **C6** in **CC** accordingly to 01 (see page 16).

3.1.1 WIRING SCHEME FOR MOTOR ON THE RIGHT SIDE AND GATE CLOSING LEFT (inside view)

ONLY FOR MOTORS WITH MAGNETIC LIMIT SWITCHES

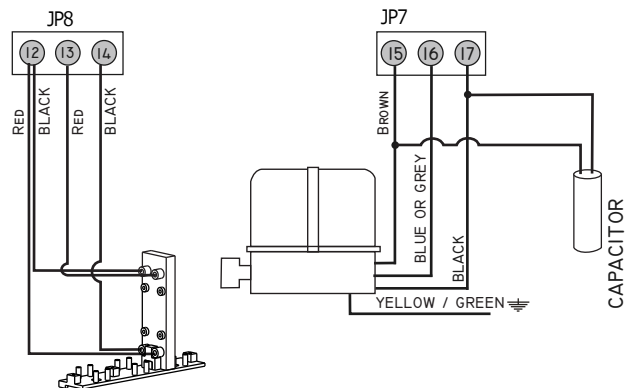

MAGNETIC LIMIT SWITCHES FIXING (inside view)

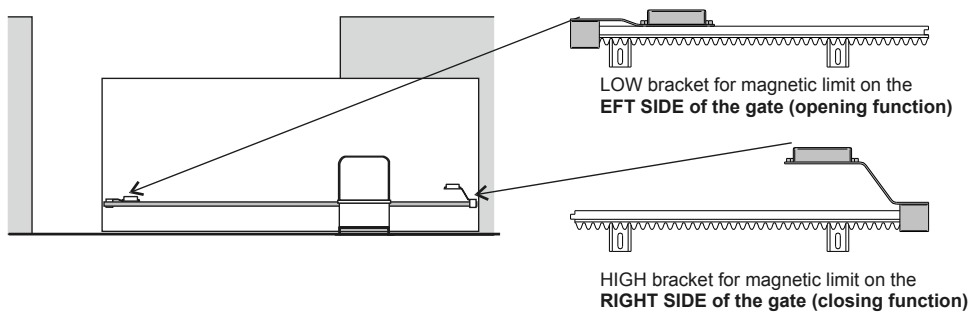

In case of gate opening from right to left please adjust parameter **C6** in **CC** accordingly to 01 (see page 16).

3.2 MAIN POWER wiring

Pole disconnect means must be incorporated according to current rating.

Connect 230V power to **18 - 19 - 20** terminals on **JP9** terminal block, paying attention to respect polarity (18 PHASE- 20 NEUTRAL).

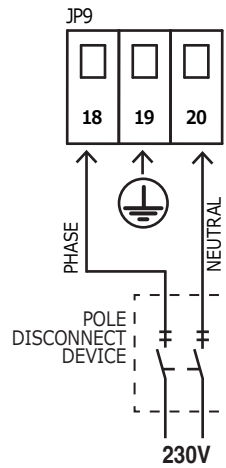

3.3 START controls wiring

Wire the START control/push-button to **1** and **4** terminals on **JP4** terminal block (N.O. contact).

Additional START controls/push-buttons can be wired in **parallel** (N.O. contact).

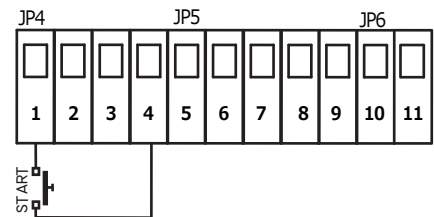

3.3.1 TIMER (for permanent opening command) wiring

Wire the TIMER to **1** and **4** terminals on **JP4** terminal block (N.O. contact).

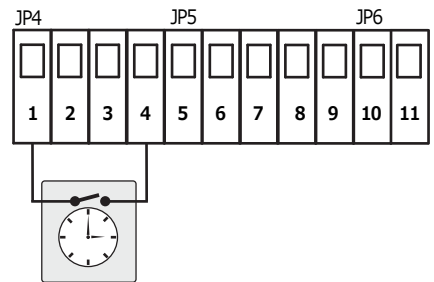

3.3.2 KEY-SWITCH wiring

Wire the KEY-SWITCH to **1** and **4** terminals on **JP4** terminal block (N.O. contact).

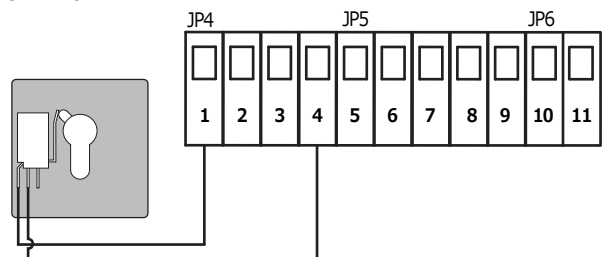

3.4 PEDESTRIAN START controls wiring

Wire the PEDESTRIAN START control/push-button to **3** and **4** terminals on **JP4** terminal block (N.O. contact).

Additional PEDESTRIAN START controls/push-buttons can be wired in parallel (N.O. contact)

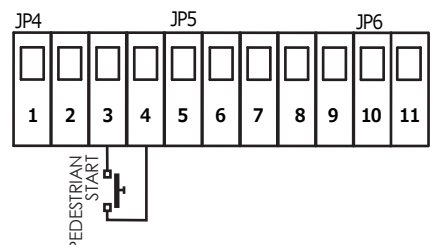

3.5 STOP push-button wiring

Wire the STOP push-button to **2** and **4** terminals on **JP4** terminal block.
Additional STOP controls/push-buttons can be wired in parallel (N.C. contact)

⚠ The wiring of an emergency stop push-button is highly recommended for the safety of people and objects.

Note: Should you need to temporary exclude the STOP connections, please set **P1** parameter in the ACCESSORIES menu to **00**=DISABLED.

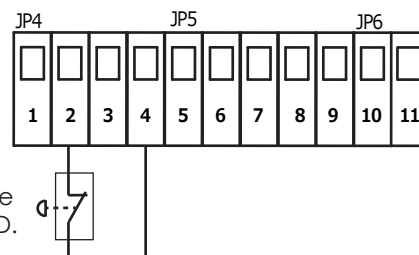

3.6 PHOTOCELLS wiring

3.6.1 CLOSING Photocells

Power the CLOSING PHOTOCELLS wiring them to terminals **7 - 8 - 9** on **JP5** terminal block.

Wire the N.C. contact of the photocells to terminals **5 - 7** on **JP5** terminal block.

The closing photocells will behave as follows:

- If an obstacle interrupts the photocell beam when the gate is closing, the automation **STOPS** and **REVERSES** in about 1.5 seconds.
- An obstacle detected by the photocells when the gate is OPENING does not cause any effect.

Additional sets of CLOSING PHOTOCELLS can be wired in series (N.C. contact).

⚠ For safety reasons at least one set of photocells must be installed to protect the CLOSING area of the gate.

Note: Should you need to temporary exclude the CLOSING PHOTOCELLS connections, please set **P2** parameter in the ACCESSORIES menu to **00**=DISABLED.

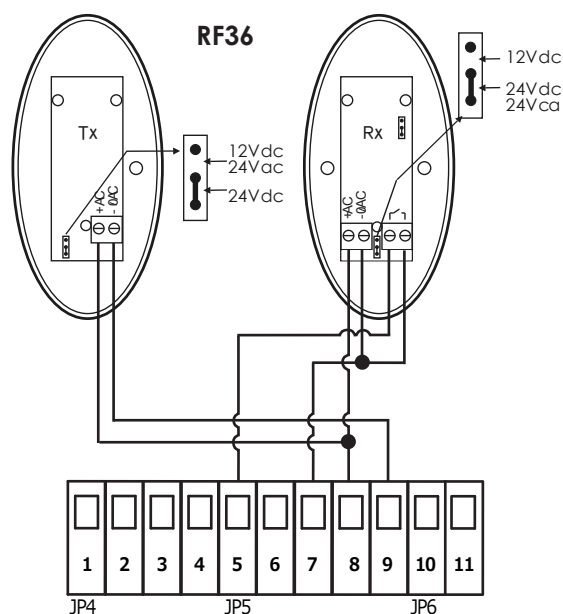

3.6.2 OPENING Photocells

Power the OPENING PHOTOCELLS wiring them to terminals **7 - 8 - 9** on **JP5** terminal block.

Wire the N.C. contact of the photocells to terminals **6 - 7** on **JP5** terminal block.

The opening photocells will behave as follows:

- If an obstacle interrupts the photocell beam when gate is opening, the automation **STOPS** and **REVERSES** in about 3 seconds.

Additional sets of OPENING PHOTOCELLS can be wired in series (N.C. contact).

⚠ For safety reasons at least one set of photocells must be installed to protect the OPENING area of the gate.

Note: Should you need to temporary exclude the OPENING PHOTOCELLS connections, please set **P3** parameter in the ACCESSORIES menu to **00**=DISABLED.

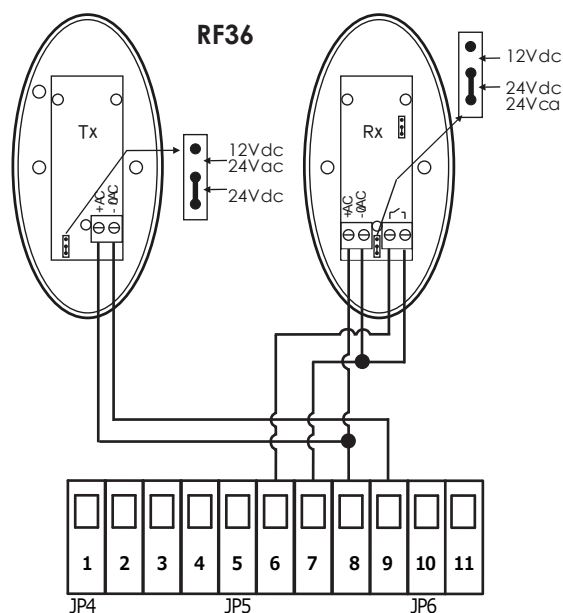

3.7 SAFETY EDGE wiring

3.7.1 CLOSING (Mechanical) Safety Edge

Wire the CLOSING SAFETY EDGE to terminals **5 - 9** on **JP5** terminal block.

- If the safety edge meet any obstacle while the gate is **CLOSING**, the automation **STOPS** and **REVERSES**.
- An obstacle detected by the safety edge while the gate is **OPENING** does not cause any effect.

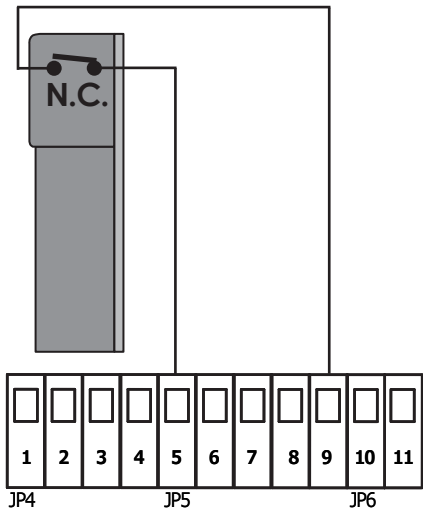

(Mechanical) SAFETY EDGE + PHOTOCELLS

Wire the (Mechanical) SAFETY EDGE in series to the receiver photocell (N.C. contact)

- If the safety edge meet any obstacle while the gate is **CLOSING**, the automation **STOPS** and **REVERSES**.
- An obstacle detected by the safety edge while the gate is **OPENING** does not cause any effect.

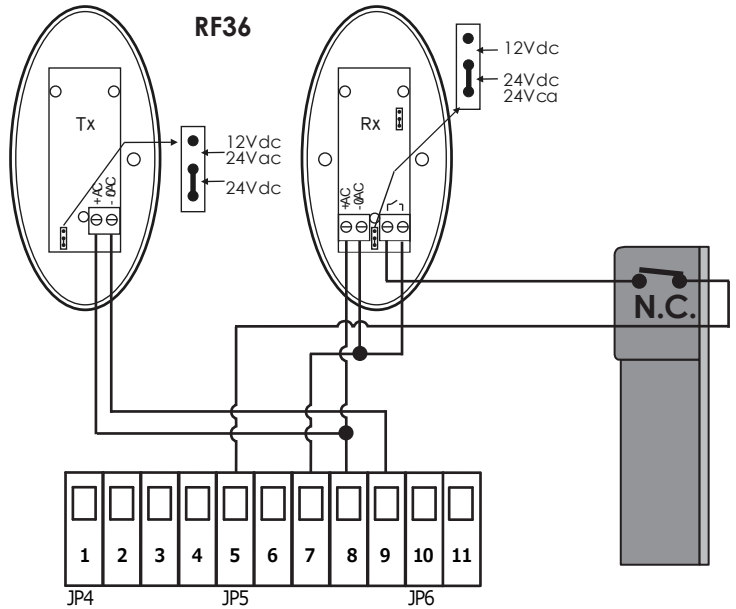

3.7.2 OPENING (Mechanical) Safety Edge

Wire the OPENING SAFETY EDGE to terminals **6 - 9** on **JP5** terminal block.

- If the safety edge meet any obstacle while the gate is **OPENING**, the automation **STOPS** and **REVERSES** for about 3 seconds.
- An obstacle detected by the safety edge while the gate is **CLOSING** does not cause any effect.

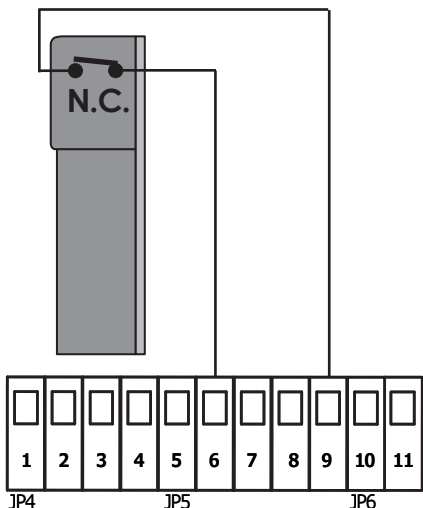

(Mechanical) SAFETY EDGE + PHOTOCELLS

Wire the (Mechanical) SAFETY EDGE in series to the receiver photocell (N.C. contact)

- If the safety edge meet any obstacle while the gate is **OPENING**, the automation **STOPS** and **REVERSES** for about 3 seconds.
- An obstacle detected by the safety edge while the gate is **CLOSING** does not cause any effect.

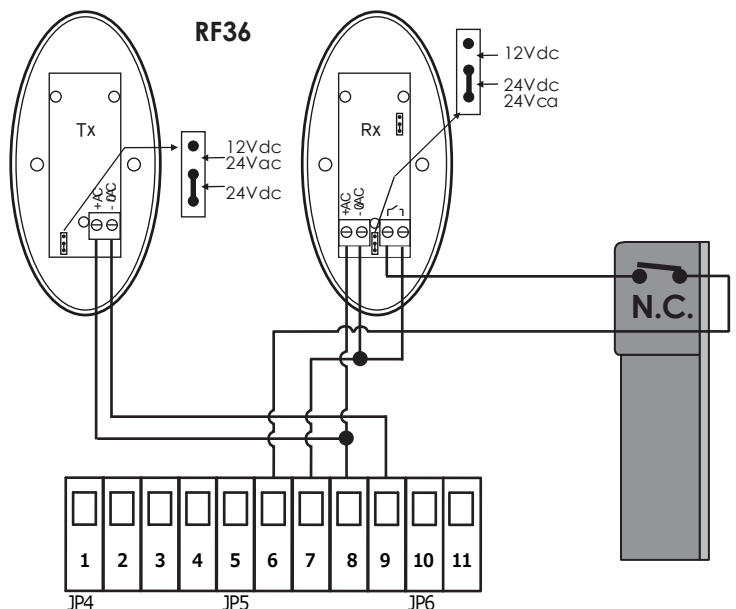

3.7.3 CLOSING SAFETY EDGE 8K2 type

Wire the CLOSING SAFETY EDGE 8K2 to terminals **5 - 9** on **JP5** terminal block.

Please make sure that parameter **P2** in **PP** menu is set on **02**.

- If the safety edge meet any obstacle while the gate is **CLOSING**, the automation **STOPS** and **REVERSES**.
- An obstacle detected by the safety edge while the gate is **OPENING** does not cause any effect.

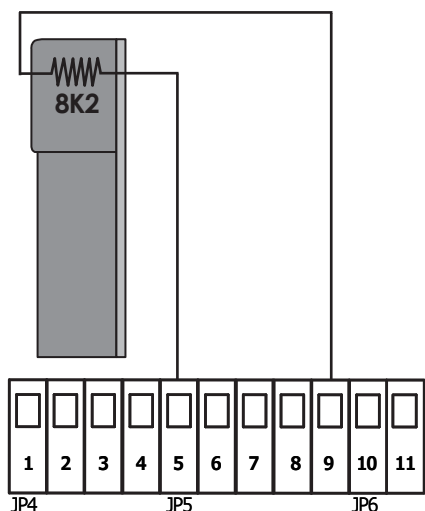

SAFETY EDGE 8K2 + PHOTOCELLS

Wire the 8K2 safety edge in series to the receiver photocell (N.C. contact)

Please make sure that parameter **P2** in **PP** menu is set on **02**.

- If the safety edge meet any obstacle while the gate is **CLOSING**, the automation **STOPS** and **REVERSES**.
- An obstacle detected by the safety edge while the gate is **OPENING** does not cause any effect.

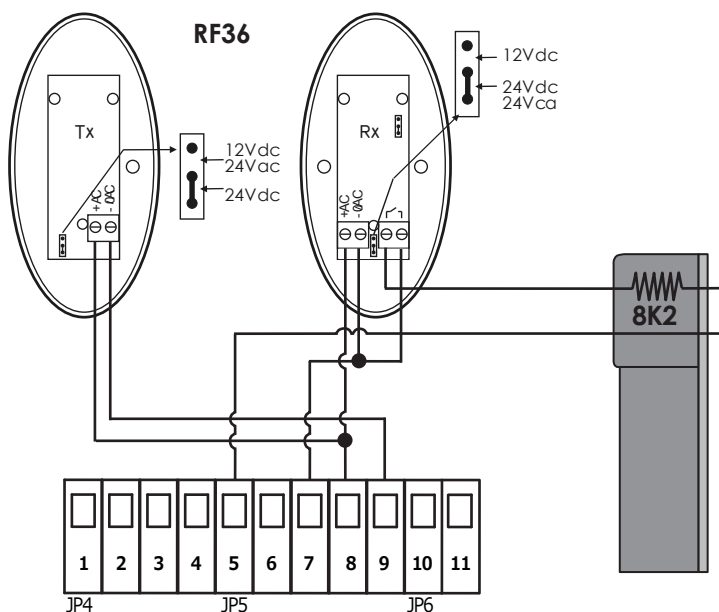

3.7.4 OPENING Safety Edge 8K2 type

Wire the OPENING SAFETY EDGE 8K2 to terminals **6 - 9** on **JP5** terminal block.

Please make sure that parameter **P3** in **PP** menu is set on **03**.

- If the safety edge meet any obstacle while the gate is **OPENING**, the automation **STOPS** and **REVERSES** for about 3 seconds.
- An obstacle detected by the safety edge while the gate is **CLOSING** does not cause any effect.

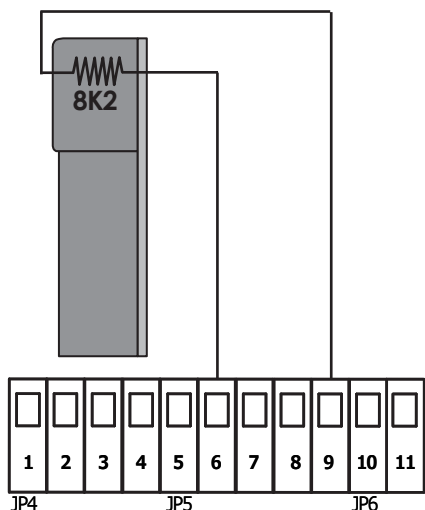

SAFETY EDGE 8K2 + PHOTOCELLS

Wire the 8K2 safety edge in series to the receiver photocell (N.C. contact)

Please make sure that parameter **P3** in **PP** menu is set on **03**.

- If the safety edge meet any obstacle while the gate is **OPENING**, the automation **STOPS** and **REVERSES** for about 3 seconds.
- An obstacle detected by the safety edge while the gate is **CLOSING** does not cause any effect.

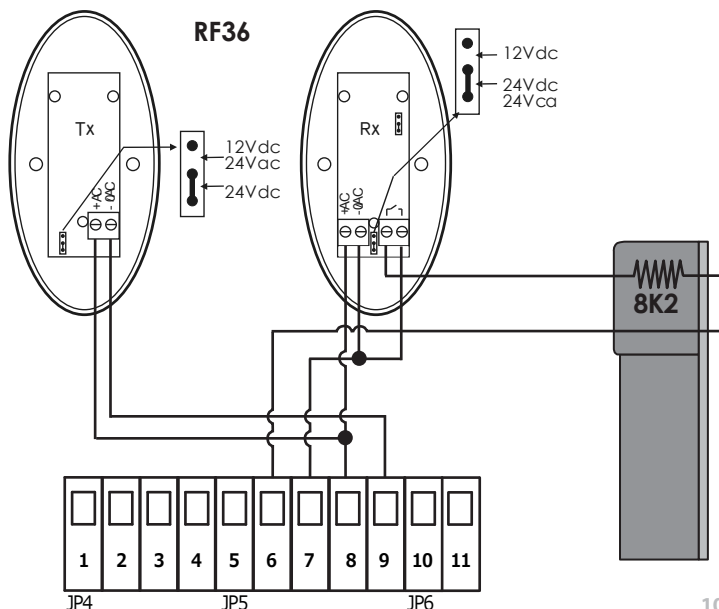

3.8 BLINKER wiring

You can wire a flashing light (20W max) to **10 - 11** terminals on **JP6** terminal block.

The flashing light will behave as follows:

- **QUICK** flashing → the gate is **OPENING**
- **SLOW** flashing → the gate is **CLOSING**
- **STILL** light on → the gate is in **PAUSE TIME** before the automatic closing

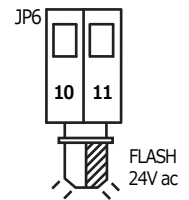

Note: You can select the kind of flashing light with **HL** parameter in the FUNCTIONS menu.

3.9 AUX/2ND RADIO CHANNEL module

Plug the additional **MRX01** module (optional) into **J5** connector, please pay attention to the module's orientation as shown in the picture.



Before setting the dip-switches **SW1** on the AUX module, make sure that the control panel is disconnected from any power supply.

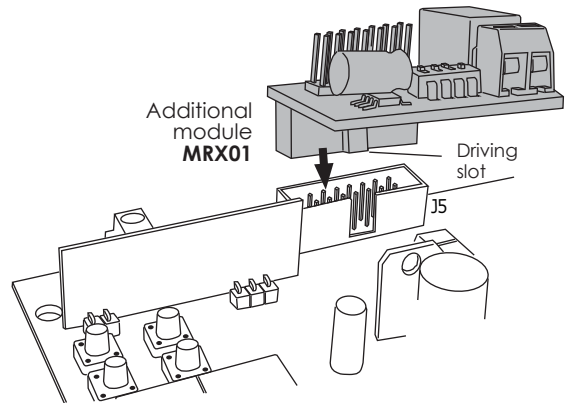
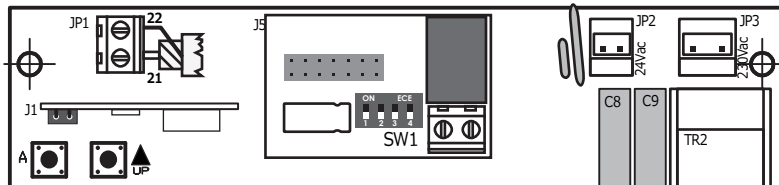

3.9.1 2ND RADIO CHANNEL settings

Note: to use the MRX04 module as a 2nd radio channel, you need to save the corresponding radio code.

Please refer to RADIO menu, parameter **A3**.

Select the AUX module settings with SW1 dip-switch-block:

STABLE switch

Electric contact closes every time you press the remote control.
To select this mode, please set the dip-switches on the module as shown:
1= ON 2= OFF 3= OFF Dip-switch 4 is non influential.

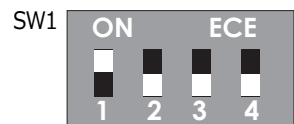

BISTABLE switch – Toggle Mode

Electric contact closes or opens every time you press the remote control.
To select this mode, please set the dip-switches on the module as shown:
1= OFF 2= ON 3= OFF Dip-switch 4 is non influential.



TIMER mode

Electric contact closes when you press the remote control and stays closed for 90 seconds.
To select this mode, please set the dip-switches on the module as shown:
1= ON 2= ON 3= OFF Dip-switch 4 is non influential.



3.9.2 CONTROL LIGHT settings

You can use the MRX01 module to control an indicator light.
The electric contact stays closed, so the light stays on, during all the opening-closing cycle.
To select this mode, please set the dip-switches on the module as shown:
1= OFF 2= OFF 3= ON Dip-switch 4 is non influential.







3.9.3 COURTESY LIGHT settings

You can also use the MRX01 module to control a courtesy light when the gate is operating. The electric contact closes since the gate starts operating fill 90 seconds after the gates stops.
To select this mode, please set the dip-switches on the module as shown:
1= ON 2= OFF 3= ON Dip-switch 4 is non influential.







4. PROGRAMMING

	Display	Description
A  ENTER	RR	RADIO menu
 UP  DOWN SCROLL	CC	PROGRAMMING menu
A  CONFIRM	FF	FORCE menu
B  EXIT	HH	FUNCTIONS menu
	LL	TIMES menu
	PP	ACCESSORIES menu
	UU	UI Counter (number of cycles from 00.00.00 to 99.99.99)

This control panel can be used with standard fix code radio transmitters as well as with rollig-code radio transmitters. Transmitter's version must be chosen before starting any commissioning procedure. Once the first radio radio code has been stored into the receiver the control panel will work with such type of radio transmitter only (fix-code OR rolling code). Reset will not be possible.





4.1 RR RADIO menu

You can store up to **64 different radio codes** on this control panel .





Press button A  and use  UP  DOWN to select menu RR
then press button A  to enter the RADIO menu: display will show R _

Use  UP  DOWN buttons to scroll the lower level menu and select:

R1 Saving a new remote control code – standard START command

1	Use  UP  DOWN buttons to move inside the menu, till the display shows:	RR
2	Now press and hold the remote control and simultaneously press button A  on the control panel. The display shows the radio code position.	01 02 64 (max)
3	If the display shows It means that memory is full and no further code can be stored.	FL
Repeat steps 1) and 2) to save another remote control as START command.		
4	Press button B  to go back to the top level menus, then press button B  again till the display shows:	Sd
Or wait the timeout (20 seconds) to exit.		

R2 Saving a new remote control code – PEDESTRIAN START command

1	Use  UP  DOWN buttons to move inside the menu, till the display shows:	RR
2	Now press and hold the remote control and simultaneously press button A  on the control panel. The display shows the radio code position.	01 02 64 (max)
3	If the display shows It means that memory is full and no further code can be stored.	FL
Repeat steps 1) and 2) to save another remote control as PEDESTRIAN START command.		
4	Press button B  to go back to the top level menus, then press button B  again till the display shows:	Sd
Or wait the timeout (20 seconds) to exit.		

R 3 Saving a new radio code for the 2ND RADIO CHANNEL



AUX optional radio module is needed to get a 2nd Radio Channel

1	Use buttons to move inside the menu, till the display shows:	R 3
2	Now press and hold the remote control and simultaneously press button on the control panel. The display shows the radio code position	01 02 64 (max)
3	If the display shows It means that memory is full and no further code can be stored.	FL
Repeat steps 1) and 2) to save another remote control for the 2ND RADIO CHANNEL		
4	Press button to go back to the top level menus, then press button again till the display shows: or wait the timeout (20 seconds) to exit	Sd

R 4 Deleting an existing remote control code

1	Use buttons to move inside the menu, till the display shows:	R 4
2	Press button to confirm	
3	Use buttons to select the position of the code you want to delete	01...0264
4	Press and hold button for about 5 seconds till the display shows	Sd
5	Release button , control unit returns to stand-by	--
Repeat steps 1) to 5) to delete other existing remote control codes		
6	Press button to go back to the top level menus, then press button again till the display shows: or wait the timeout (20 seconds) to exit	Sd



R 5 Deleting ALL stored radio codes

1	Use buttons to move inside the menu, till the display shows:	R 5
2	Press and hold button for about 10 seconds till the display shows	Sd
3	Release button , control unit returns to stand-by	--
4	Press button to go back to the top level menus, then press button again till the display shows: or wait the timeout (20 seconds) to exit	Sd

4.2 [] PROGRAMMING menu

Press button **A**  and use   to select menu [] ,

then press button **A**  to enter the PROGRAMMING menu: display will show [] _





Use   buttons to scroll the lower level menu.

4.2.1 Selecting the PROGRAMMING MODE

[] AUTOMATIC programming mode, with OBSTACLE DETECTION

Before starting this programming procedure make sure that the TORQUE/POWER is not set too high: in that case please adjust parameter **F1** in **FF** menu to reduce it.

Automatic programming procedure: the control panel **automatically** sets motors' working times and force as well as the sensibility level for the obstacle detection (amperometric).

1	Use   buttons to move inside the menu, till the display shows:	
2	Press and hold button A  for about 10 seconds . The control panel starts the automatic programming procedure, the gate will: <ul style="list-style-type: none"> • If open, it start closing till the limit switch bracket meets the motor • Then it opens till the opening limit position • Stops and reverses till the fully closed position • The control unit automatically sets deceleration about 50cm before the fully closed/open positions 	[]
3	Now working times, deceleration times and the level of sensibility for obstacle detection have been automatically set.	
4	Press button B  to go back to the top level menus, then press button B  again till the display shows: or wait the timeout (20 seconds) to exit	[]

If further adjustments of the sensibility level for obstacle detection are needed, please refer to setting **F3** in the **FF** FORCE menu.

C2 SEQUENTIAL programming mode









This step-by-step programming procedure allows you full control of each setting and finer professional adjustments.



The control unit is preset to be programmed by SEQUENTIAL programming mode.
Before starting this programming procedure make sure that the TORQUE/POWER is not set too high: in that case please adjust parameter **F1** in **FF** menu to reduce it

If the control panel is programmed using this procedure, **obstacle detection** function is automatically **disabled**.

You can program the control panel with the sequential procedure using button  on the control panel or using a remote control previously saved.





1	Use   buttons to move inside the menu, till the display shows:	C2
2	Press button  to confirm. The display shows:	n1
3	Press the remote control (or button  on the control panel). • The gate starts closing (if open) and then opens again till the fully open position	
4	When the gate is about to 90% of the opening path, press again the remote control (or button  on the control panel). • The gate decelerates and continues opening.	
5	When the gate has reached the fully open position, wait 2-3 seconds and then press again the remote control (or button ) the gate starts closing till the fully closed position	
6	Press button  to go back to the top level menus, then press button  again till the display shows:	5d
	or wait the timeout (20 seconds) to exit.	

If further adjustments of the motors force are needed, please refer to setting **F1** in the **FF** FORCE menu.

4.2.2 Restoring DEFAULT SETTINGS

The control panel comes with pre-set working parameters according to the automation model used. You can reset the control panel to the default settings as follows:







C3 Gear motor default settings

1	Use   buttons to move inside the menu, till the display shows:	C3
2	Press and hold button  for about 5 seconds .	
3	Press button  to go back to the top level menus, then press button  again till the display shows:	5d
	or wait the timeout (20 seconds) to exit.	

4.2.3 OPENING DIRECTION of the motor

The control unit is preset for use on gate opening from Left to Right:







C6 Opening direction of the motor can be changes as follows (paragraph 3.1)

1	Use   buttons to move inside the menu, till the display shows:	C6
2	Press and hold button A  for about 5 seconds .	
3	Use   buttons to select: Gate opening from Left to Right (view from inside courtyard) Gate opening from Right to Left (view from inside courtyard)	00 01
4	Press button B  to go back to the top level menus, then press button B  again till the display shows: or wait the timeout (20 seconds) to exit.	5d

4.2.4 LIMIT SWITCHES mode selecting

This control unit can be used with **ELECTROMECHANICAL LIMIT SWITCHES** (N.C. contact)
or with **MAGNETIC LIMIT SWITCHES** (N.O. contact)



C7 LIMIT SWICTHES mode

1	Use   buttons to move inside the menu, till the display shows:	C7
2	Press and hold button A  for about 5 seconds .	
3	Use   buttons to select: Use with ELECTROMECHANICAL Limit Switches (N.C. contact) Use with MAGNETIC Limit Switches (N.O. contact)	00 01
4	Press button B  to go back to the top level menus, then press button B  again till the display shows: or wait the timeout (20 seconds) to exit.	5d







4.3 FF FORCE menu

Use this menu to adjust the **sensibility level of the obstacle detection** in case of AUTOMATIC Programming mode (**C1**)
or to adjust the **motors force** in case of SEQUENTIAL Programming mode (**C2**).







Press button **A**  and use   to select menu **FF**,
 then press button **A**  to enter the FORCE menu: display will show **F _**

Use   buttons to scroll the lower level menus:

F1 TORQUE/POWER adjustment

1	Use   buttons to move inside the menu, till the display shows:	F1
2	Press button A  to confirm. The display now shows the current torque/power level for motor :	01 (min) 02 ... 10 (max)
3	Use   buttons to change the motor torque/power level.	
4	Press button B  to go back to the top level menus, then press button B  again till the display shows: or wait the timeout (20 seconds) to exit.	Sd

F3 OBSTACLE DETECTION adjustment

1	Use   buttons to move inside the menu, till the display shows:	F3
2	Press button A  to confirm. The display now shows the current sensibility level for the obstacle detection of motor :	00 (OFF) 01 (min) ... 10 (max)
3	Use   buttons to change the motor sensibility level	
4	Press button B  to go back to the top level menus, then press button B  again till the display shows: or wait the timeout (20 seconds) to exit.	Sd

4.4 HH FUNCTIONS menu

Use this menu to enable/disable special settings.

1 = function is **ON**
0 = function is **OFF**







Press button A  and use   to select menu **HH**.

then press button A  to enter the FUNCTIONS menu: display will show **H _**

Use   buttons to scroll the lower level menus:







H1 MULTI-OCCUPATION Function

This function grants **priority to the opening command**; when two people activate the gate at the same time the first opening command prevails, while opening the control panel ignores any further command.

1	Use   buttons to move inside the menu, till the display shows:	H1
2	Press button A  to confirm.	
3	Use   buttons to select: MULTI-OCCUPATION Function OFF MULTI-OCCUPATION Function ON	00 01
4	Press button B  to go back to the top level menus, then press button B  again till the display shows: or wait the timeout (20 seconds) to exit.	Sd

H2 PRE-BLINKING Function

This function makes the flashing light **pre-blinking** for **4-5 seconds** before the gate starts opening.

1	Use   buttons to move inside the menu, till the display shows:	H2
2	Press button A  to confirm.	
3	Use   buttons to select: PRE-BLINKING Function OFF PRE-BLINKING Function ON	00 01
4	Press button B  to go back to the top level menus, then press button B  again till the display shows: or wait the timeout (20 seconds) to exit.	Sd







H 3

DECELERATION Function

This function decelerates the leaves at the end of the opening/closing cycle.

Two modes for deceleration can be chosen:







- Standard DECELERATION
(the gate directly slows down from standard travel to decelerated speed)
- Soft DECELERATION
(the gate gradually slows down from standard travel to decelerated speed)

1	Use   buttons to move inside the menu, till the display shows:	H 3
2	Press button  to confirm.	
3	Use   buttons to select: DECELERATION Function OFF DECELERATION Function ON Soft DECELERATION function ON	00 01 02
4	Press button  to go back to the top level menus, then press button  again till the display shows: or wait the timeout (20 seconds) to exit.	S d

H 4

PHOTOCELLS TEST Function







If this function is enabled, the control panel performs a quick start-up test with the photocells to make sure that they are in operation.

1	Use   buttons to move inside the menu, till the display shows:	H 4
2	Press button  to confirm.	
3	Use   buttons to select: PHOTOCELLS TEST Function OFF PHOTOCELLS TEST Function ON	00 01
4	Press button  to go back to the top level menus, then press button  again till the display shows: or wait the timeout (20 seconds) to exit.	S d

H 7







START PULSE Function

This setting makes the motor operate full power for **1 second** when starting opening to overcome gate inertia due to cold weather or long inactivity.

1	Use   buttons to move inside the menu, till the display shows:	H 7
2	Press button  to confirm.	
3	Use   buttons to select: START PULSE Function OFF START PULSE Function ON	00 01
4	Press button  to go back to the top level menus, then press button  again till the display shows: or wait the timeout (20 seconds) to exit.	S d

H8 QUICK CLOSING Function

This setting makes the gate close **2 seconds** after the car has gone through the photocells beam, without waiting for the entire pause time to elapse.







1	Use   buttons to move inside the menu, till the display shows:	H8
2	Press button  to confirm.	
3	Use   buttons to select: QUICK CLOSING Function OFF QUICK CLOSING Function ON	00 01
4	Press button  to go back to the top level menus, then press button  again till the display shows: or wait the timeout (20 seconds) to exit.	5d

HA SEPARATE PUSH-BUTTONS Function

This allows to use to different push-buttons/controls for opening and closing.







To use this function, you need to wire:

- opening push-button/control to **START** terminals
- closing push-button/control to **PEDESTRIAN START** terminals







1	Use   buttons to move inside the menu, till the display shows:	HA
2	Press button  to confirm.	
3	Use   buttons to select: SEPARATE PUSH-BUTTONS Function OFF SEPARATE PUSH-BUTTONS Function ON	00 01
4	Press button  to go back to the top level menus, then press button  again till the display shows: or wait the timeout (20 seconds) to exit.	5d

HC MOTOR TEST Function

If this function is enabled, the control panel performs a quick start-up test with the motor to make sure that they are in operation.

1	Use   buttons to move inside the menu, till the display shows:	HC
2	Press button  to confirm.	
3	Use   buttons to select: MOTOR TEST Function OFF MOTOR TEST Function ON	00 01
4	Press button  to go back to the top level menus, then press button  again till the display shows: or wait the timeout (20 seconds) to exit.	5d

Use these settings to select the signal mode of the flashing light according to the blinker model you have.







1	Use   buttons to move inside the menu, till the display shows:	HL
2	Press button  to confirm	
3	Use   buttons to select: BLINKING signal (Standard Flashing Light) FIX signal (LED Flashing Light)	00 01
4	Press button  to go back to the top level menus, then press button  again till the display shows: or wait the timeout (20 seconds) to exit.	5d

Use these settings to control the gate by a **DEAD MAN'S SWITCH**. The gate opens/closes only if the button is hold pressed, as soon as the button is released the gate stops opening/closing.

Wirings to the push-buttons have to be separated as follows:







START plug \longrightarrow **OPENING** push-button
PEDESTRIAN START plug \longrightarrow **CLOSING** push buttons

If this function is enabled any other radio command will be ignored and all safety systems (obstacle detection, photocells, sensitive edges,...) are not working.

1	Use   buttons to move inside the menu, till the display shows:	HP
2	Press button  to confirm	
3	Use   buttons to select: STANDARD opening/closing mode DEAD MAN'S SWITCH opening/closing mode	00 01
4	Press button  to go back to the top level menus, then press button  again till the display shows: or wait the timeout (20 seconds) to exit.	5d







4.5 L L TIMES menu

Use this menu to adjust motors **operating time** and **pause time** before automatic closing.

Press button A  and use   to select menu L L ,
then press button A  to enter the TIMES menu: display will show L _
Use   buttons to scroll the lower level menus:







L 3 AUTOMATIC CLOSING Pause time

Use this menu set the pause time for the Automatic Closing (from 0 to 99 seconds).

1	Use   buttons to move inside the menu, till the display shows:	L 3
2	Press button A  to confirm.	
3	Use   buttons to set the pause time for automatic closing:	00(OFF) 01 ... 99(max)
4	Press button B  to go back to the top level menus, then press button B  again till the display shows: or wait the timeout (20 seconds) to exit.	S d

L 4 PEDESTRIAN AUTOMATIC CLOSING Pause time

Use this menu set the pause time for the Pedestrian Automatic Closing (from 0 to 99 seconds).

1	Use   buttons to move inside the menu, till the display shows:	L 4
2	Press button A  to confirm.	
3	Use   buttons to set the pause time for Pedestrian automatic closing:	00(OFF) 01 ... 99(max)
4	Press button B  to go back to the top level menus, then press button B  again till the display shows: or wait the timeout (20 seconds) to exit.	S d

OPERATING TIME

Motor's operating time is controlled by limit switches.

In case of fault of the limit switches the motor will stop running in any case after 120 seconds.







L 7 DECELERATION TIME

Use this setting to adjust opening/closing deceleration time for motor (from 1 to 10 seconds).









Before adjusting this setting, please make sure that parameter **H3** in **HH** FUNCTIONS menu is:

H3 = 1 Deceleration ON

1	Use   buttons to move inside the menu, till the display shows:	L 7
2	Press button A  to confirm.	
3	Use   buttons to reduce/increase motor deceleration time:	00 (OFF) 01 (min) ... 10 (max)
4	Press button B  to go back to the top level menus, then press button B  again till the display shows: or wait the timeout (20 seconds) to exit.	5d

L 9 PEDESTRIAN OPENING TIME

Use this setting to adjust operating time for **Pedestrian Opening for gate** (from 1 to 20 seconds).







1	Use   buttons to move inside the menu, till the display shows:	L 9
2	Press button A  to confirm.	
3	Use   buttons to set Motor 1 Pedestrian opening time:	00 (total opening) 01 (min) ... 20 (max)
4	Press button B  to go back to the top level menus, then press button B  again till the display shows: or wait the timeout (20 seconds) to exit.	5d

4.6 PP ACCESSORIES menu







Use this menu to manage terminals for wiring the accessories (**controls and safety devices**).

Press button A  and use   to select menu **PP**,
then press button A  to enter the ACCESSORIES menu: display will show **P_**
Use   buttons to scroll the lower level menus:







P1 EMERGENCY STOP terminals

1	Use   buttons to move inside the menu, till the display shows:	P1
2	Press button A  to confirm.	
3	Use   buttons to select:	00 01
	STOP Push-button – NOT WIRED STOP Push-button - WIRED	
4	Press button B  to go back to the top level menus, then press button B  again till the display shows: or wait the timeout (20 seconds) to exit.	5d

P2 CLOSING PHOTOCELLS terminals

1	Use   buttons to move inside the menu, till the display shows:	P2
2	Press button A  to confirm.	
3	Use   buttons to select:	00 01 02
	CLOSING Photocells - NOT WIRED CLOSING Photocells - WIRED 8K2 Safety Edge	
4	Press button B  to go back to the top level menus, then press button B  again till the display shows: or wait the timeout (20 seconds) to exit.	5d

P3 OPENING PHOTOCELLS / SAFETY EDGE terminals

1	Use   buttons to move inside the menu, till the display shows:	P3
2	Press button A  to confirm.	
3	Usare i tasti   per selezionare:	00 01 02 03
	Opening Photocells/Safety Edges - NOT WIRED Opening Photocells - WIRED Standard Safety Edge (NC contact) - WIRED 8K2 Safety Edge - WIRED	
4	Press button B  to go back to the top level menus, then press button B  again till the display shows: or wait the timeout (20 seconds) to exit.	5d

5. TROUBLE-SHOOTING

Display	Issue	Possible Reasons	Solutions
8.8	DISPLAY OFF	Power-cut	Check main power supply
		Burnt fuses	Replace the fuses
		Transformer problem	Check all connections and input/output voltage
FC	CLOSING PHOTOCELLS	Misalignment of the photocells	Check transmitter and receiver position/alignment
		Obstacle disturbing the photocells beam	Check and remove the obstacle. Also check the photocells eye and remove any dust or dirty deposit.
		Incorrect wiring	Check all electrical wirings following the diagram
		Photocell not powered	Check power and voltage both on receiving and transmitting photocell
		Closing photocells not wired	Wire the photocells or disabled corresponding parameter (please refer to paragraph 3.6.1)
FA	OPENING PHOTOCELLS	Misalignment of the photocells	Check transmitter and receiver position/alignment
		Obstacle disturbing the photocells beam	Check and remove the obstacle. Also check the photocells eye and remove any dust or dirty deposit
		Incorrect wiring	Check all electrical wirings following the diagram
		Photocell not powered	Check power and voltage both on receiving and transmitting photocell
		Opening photocells not wired	Wire the photocells or disable corresponding parameter (please refer to paragraph 3.6.2)
FE	PHOTOCELLS TEST FAILED	Incorrect wiring	Check all electrical wirings following the diagram
		Unfitting photocells	Please install original photocells
SP	EMERGENCY STOP	Incorrect wiring	Check all electrical wirings following the diagram (paragraph 3.5)
		Emergency STOP push-button not wired	Wire the STOP push-button or disable corresponding parameter (please see paragraph 3.5)
ST	START COMMAND	The control panel is receiving a continuous START command	Make sure that all START controls connect are properly working and correctly wired (N.O. contact)
Pd	PEDESTRIAN START COMMAND	The control panel is receiving a continuous PEDESTRIAN START command	Make sure that all PEDESTRIAN START controls connect are properly working and correctly wired (N.O. contact)
nE	MOTORS TEST FAILED	Motors not wired	Wire the motors as shown in the diagram
		Incorrect wiring	Check motors electrical wiring (please see paragraph 3.3)
		Electrical coil broken	Use a tester to check the coil status
EL	LIMIT SWITCHES	Faulty limit switch	Replace the limit switch
		Lack in wirings	Heck wirings to control unit and limit switch
01 02 50 64	RADIO	The control panel is continuously receiving a radio command	Check all keys of the remote controls. Make sure that there is no stuck key (led on the remote control always on). If needed remove the battery from the remote control and check that the error message disappears from the display

6. DISPOSAL



Do not pollute the environment

Some electronic components may contain polluting substances. Ensure materials are passed to the authorised collection centres, according to the laws and the regulations on force, for safe disposal.



= DEFAULT Settings

RR RADIO Menu

R1	SAVING a new remote control – START command	01.....64 (max) FL = memory is full
R2	SAVING a new remote control – PEDESTRIAN START command	01.....64 (max) FL = memory is full
R3	SAVING a new remote control – 2° RADIO CHANNEL <i>With optional AUX module only</i>	01.....64 (max) FL = memory is full
R4	DELETING an existing remote control code	01.....64
R5	DELETING ALL stored remote controls	

CC PROGRAMMING Menu

C1	AUTOMATIC Programming Procedure with OBSTACLE DETECTION	
C2	SEQUENTIAL Programming Procedure	
C3	Reset to Default Settings for RAM openers	
C6	OPENING DIRECTION of the motor	00 = RIGHT 01 = LEFT
C7	LIMIT SWITCHES mode selection	00 = ELECTROMECHANICAL 01 = MAGNETIC



FF FORCE Menu

F1	TORQUE/POWER adjustment	
F3	OBSTACLE DETECTION level adjustment	



SPECIAL FUNCTIONS Menu

H1	MULTI-OCCUPATION Function	00 = OFF 01 = ON
H2	PRE-BLINKING Function	00 = OFF 01 = ON
H3	DECELERATION Function	00 = OFF 01 = ON
H4	PHOTOCELLS TEST Function	00 = OFF 01 = ON
H7	START PULSE Function	00 = OFF 01 = ON
H8	QUICK CLOSING Function	00 = OFF 01 = ON
HA	SEPARATE PUSH-BUTTONS Function	00 = OFF 01 = ON
HC	MOTORS TEST Function	00 = OFF 01 = ON
HL	FLASHING LIGHT mode	00 = flashing 01 = FIX (LED)
HP	DEAD MAN'S SWITCH mode	00 = STANDARD mode 01 = DEAD MAN'S SWITCH mode

LL TIMES Menu

L3	AUTOMATIC CLOSING pause time	00 = OFF 01 (min).... 3 ()..... 99 (max)
L4	PEDESTRIAN CLOSING pause time	00 = OFF 01 (min).... 7 ()..... 99 (max)
L7	DECELERATION TIME	00 = OFF 01 (min).... 7 ()..... 10 (max)
L9	PEDESTRIAN OPENING time	00 = OFF 01 (min).... 7 ()..... 20 (max)

PP ACCESSORIES Menu

P1	EMERGENCY STOP terminals	00 = DISABLED 01 = ENABLED/WIRED ()
P2	CLOSING PHOTOCELLS terminals	00 = DISABLED 01 = ENABLED/WIRED ()
P3	OPENING PHOTOCELLS/ SAFETY EDGE terminals	00 = DISABLED 01 = Opening photocells WIRED () 02 = Safety Edge (NC) WIRED 03 = Safety Edge 8K2 WIRED

Display MESSAGES

--	Stand-by. Control Panel ready to work
FC	Closing PHOTOCELLS operating
FR	Opening PHOTOCELLS operating
SP	STOP command operating
ST	START command operating
Pd	PEDESTRIAN START command operating
r -	Receiving a radio code (12 bit)
rd	Receiving a radio code (24 bit)
R	Obstacle detection intervention
Sd	Programming settings have been saved
00	Rotating segments: motors running
---	Small dots: brightness of the dot is proportional to the force settings

CE COMPLIANCE DECLARATION

Manufacturer: **PROTECO S.r.l.**

Address: Via Neive, 77 – 12050 Castagnito (CN) – ITALIA

declares that

The product type: **Q80A** electronic controller for sliding gate automation (1 motor), 220V

Models: PQ80S

Accessories: MRX01

Is built to be integrated into a machine or to be assembled with other machinery to create a machine under provisions of 2006/42/EC Machinery Directive.

It complies with the essential requirements of EEC Directives:

2006/95/EC Low Voltage Directive

2004/108/EC Electromagnetic Compatibility Directive

R&TTE 99/5 Radio & Telecommunications Terminal Equipments Directive

The manufacturer declares that the start-up of the machinery is not permitted unless the machine, in which the product is incorporated or of which is becoming a component, has been identified and declared as conformed to 2006/42/EC Machinery Directive.

Note: These products have undergone test in a typical uniform configuration

Castagnito, May 26th 2014

Angela Gallo
Managing Director

