

YX-08E/I

Yala electromagnetica aplicabila
cu memorie mecanica

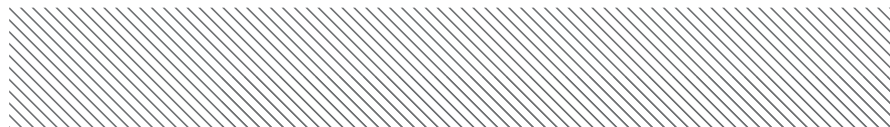

DESCRIERE

Yala electromagnetica, aplicabila, cu montare universala (stanga/dreapta) si memorie mecanica. Yala poate fi actionata si de la exterior cu o cheie.

CARACTERISTICI

- Deschidere electrica sau manuala
- Buton in interior/Butuc cu chei in exterior
- Montare universala – stanga sau dreapta
- Montare pe usi de la 20 la 90mm grosime
- Memorie mecanica
- Material: Inox

SPECIFICATII

- Tensiune de alimentare - 10-25Vcc
- Curent: 1.5A la impuls, 2.5A maxim
- Temperatura: -40°C - +80°C
- Umiditate: 70%
- Zgomot: <30dB
- Impedanta: <6Ω
- Tensiunea de izolare: 250V
- Dimensiuni: 131.5x100x42mm (yala), 36x100x44mm (opritor)

! NU TINETI ALIMENTATA YALA MAI MULT DE 3 SECUNDE.

SCHEMA ELECTRICA

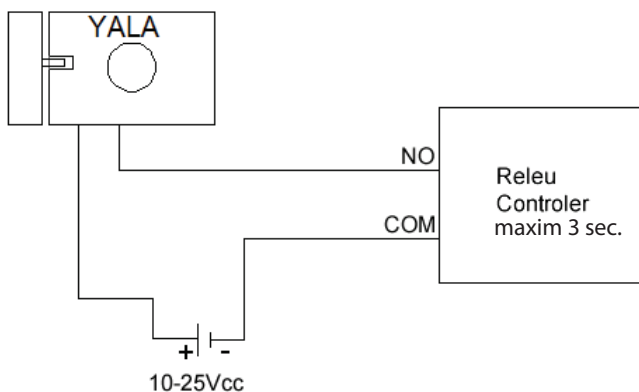

YX-08E

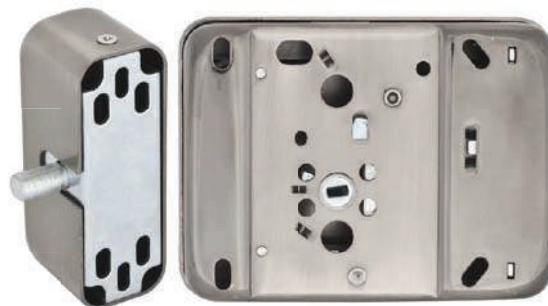

YX-08I



Fisa tehnica



YX-08E/I

Yala electromagnetica aplicabila
cu memorie mecanica

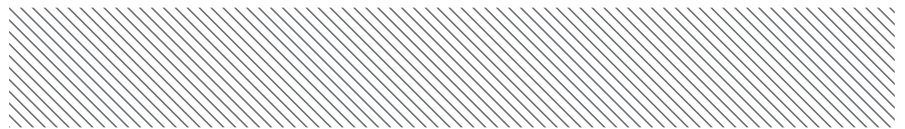

YX-08I

Montare pe usa

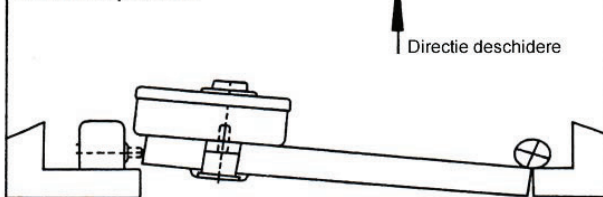

XY-08E

Montare pe toc

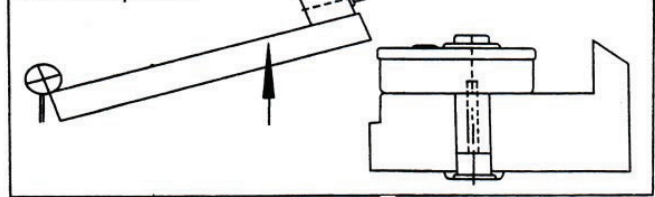

Montare pe toc

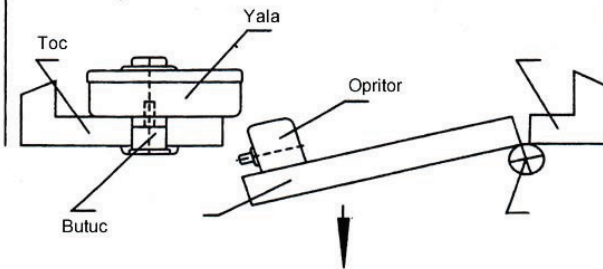

Montare pe usa

