



CE

119EV88EN

OPERATOR
FOR GARAGE DOORS



INSTALLATION MANUAL

V6000

English

EN



CAUTION!
important personal safety instructions:
READ CAREFULLY!



Foreword

- This product should only be used for the purpose for which it was explicitly designed. Any other use is considered dangerous. CAME Cancelli Automatici S.p.A. is not liable for any damage resulting from improper, wrongful or unreasonable use
- Keep these warnings with the installation and use manuals issued with the automation system.

Before installing

(preliminary check: in case of a negative outcome, do not proceed until you have complied with the safety requirements)

- Check that the part you intend to automate is in good mechanical condition, balanced and aligned, and that it opens and closes properly. Make sure that proper mechanical stops are already in place
- If the operator will be installed at a height of less than 2.5 m from the ground or other access level, check if any protection devices and/or warnings are necessary
- Read all instructions carefully before performing any operation; incorrect installation may be hazardous and cause damage to persons and objects.
- Any leaves fitted with pedestrian entrances onto which an operator will be installed must have a blocking mechanism when the leaf is in motion
- Make sure that the opening of the automated leaf is not an entrapment hazard as regards any surrounding fixed parts
- Do not mount the operator upside down or onto any elements that may fold under its weight. If needed, add suitable reinforcements at the points where it is secured
- Do not install onto leaves not on level ground
- Check that any lawn watering devices will not wet the operator from the bottom up.
- Check that the temperature of the place of installation is compliant to the range defined in this manual.

Installation

- Carefully section off the entire site to prevent unauthorised access, especially by minors and children
- Be careful when handling operators that weigh more than 20 kg. In the case, make sure to have all tools for safe handling
- All opening controls (buttons, key switches, magnetic readers, etc.) must be installed at least 1.85 m from the perimeter of the manoeuvring area, or out of reach from external access via the operator. Furthermore, direct controls (buttons, touch commands, etc.) must be installed at a height of at least 1.5 m and must not be accessible to the public
- All 'hold-to-run' commands must be placed where the moving gate leaves, transit areas and driveways are completely visible
- If missing, apply a permanent label that shows the position of the release mechanism
- Before delivering to the user, check that the system is EN 12453 (impact test) standard compliant. Make sure that the operator has been properly adjusted and that the safety and protection devices as well as the manual release are working properly
- Where necessary and in plain sight, apply the Warning Signs (e.g. gate plate)

Special instructions and advice for users

- Keep the gate's area of operation clean and clear of any obstacles. Check that there is no vegetation in the area of operation of the photocells and that there are no obstacles in the operator's area of operation
- Do not allow children to play with the fixed control devices, or to remain within the gate's area of operation. Keep any remote control devices (i.e. transmitters) or any control devices away from children as well, to prevent the operator from being activated accidentally
- The operator is not designed to be used by persons (including children) whose physical, sensorial or mental capacities are limited, or who are lacking in experience or knowledge, unless said persons can be supervised or given instructions regarding using the operator by a person responsible for their safety
- Frequently check the system, to see whether any anomalies or signs of wear and tear appear on the moving parts, on the component parts, on the securing points, on the cables and any accessible connections. Keep any joints (i.e. hinges) lubricated and clean, and do the same where friction may occur (i.e. slide rails)
- Perform functional tests on photocells and sensitive edges every six months. To check that the photocells work, pass an object in front of them during closing. If the operator reverses the direction of movement or comes to a halt, the photocells work correctly. This is the only maintenance operation that must be carried out while the operator is live. Ensure that the glass on the photocells is kept clean (use a cloth slightly moistened with water; do not use solvents or any other chemicals as these could damage the devices)
- If the system requires repairs or modifications, release the operator and do not use it until safety conditions have been restored
- Cut off the power supply before releasing the operator for manual openings and before any other operation, to prevent dangerous situations. Read the instructions
- If the power cable is damaged, it must be re-

placed by the manufacturer or the technical assistance service or by a person with a similar qualification so as to prevent any risks

- It is STRICTLY FORBIDDEN for users to perform OPERATIONS THEY ARE NOT EXPLICITLY REQUIRED AND ASKED to do in the manuals. For repairs, adjustments and extraordinary maintenance, CONTACT THE SPECIALIST TECHNICAL SERVICE CENTRE
- On the periodic maintenance log, note down the checks you have done.

Special instructions and advice for all

- Avoid working near the hinges or moving mechanical parts
- Stay clear of the gate's area of operation when in motion
- Do not resist the direction of movement of the gate; this may present a safety hazard
- At all times be extremely careful about dangerous points that must be indicated by proper pictograms and/or black and yellow stripes
- When using a selector or command in 'hold-to-run' mode, keep checking that there are no people in the area of operation of the moving parts. Do this until you release the command
- The gate may move at any time without warning
- Always cut the power when cleaning or performing maintenance.

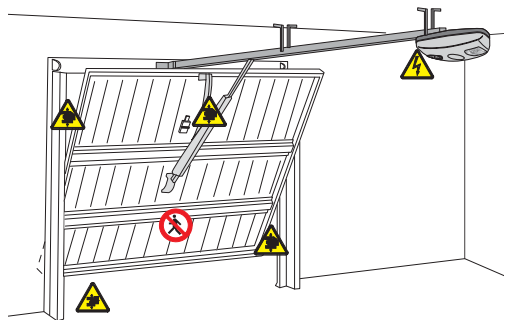

Danger of hand crushing



Danger of foot crushing





Danger - live parts



No transit during the manoeuvre

KEY

-  This symbol indicates parts to read carefully.
-  This symbol indicates parts about safety.
-  This symbol tells you what to say to the end users.

REGULATORY REFERENCES

Came Cancelli Automatici is a company with an ISO 9001-certified company quality management system and an ISO 14001-certified environmental management system. The product in question complies with the regulations referred to in the declaration of conformity.

DESCRIPTION

This product complies with the current safety regulations in force.

The operator comprises a gearmotor, an electronic circuit board with transformer, a sliding guide system with chain or belt drive, a motion transmission arm and an ABS cover with a display for programming keyboard and LED courtesy lamp.

Intended use

The V6000 operator has been designed to automate overhead and sectional doors for use in homes and apartment blocks.

 Any installation and operation that differs from what is set out in this manual is prohibited.

Limits of use

Type	V6000
Max height of canopy overhead door (m)	2.4
Max height of spring-balanced overhead door (m)	3.25
Max height for sectional doors (m)	3.20

Technical data

Type	V6000
Protection rating (IP)	40
Power supply (V - 50/60 Hz)	230 AC
Motor power supply (V)	24 DC
Absorption in Standby (W):	7
Max power of accessories (W)	35
Power rating (W)	100
Opening speed (m/min)	6
Traction force (N)	600
Operating temperature (°C)	-20 - +55
Insulation class	
Weight (kg)	4.9

Packing list

1. 1 x Operator
2. 1 x Installation manual
3. 2 x pierced mounting plates
4. 1 x Curved lever
5. 2 x support brackets
6. 3 x U-brackets
7. 1 x Rail mounting bracket
8. 1 x Door mounting bracket
9. 8 x M16 Self-tapping hex head screws
10. 1 x Screw with hex nut M6x80
11. 1 x Shaft adapter (Ø8x25)
12. 1 x Cotter Pin 3x20
13. 1 x Pin
14. 4 x M6x80 Screws with hex nut and washer
15. 1 x Slide rail

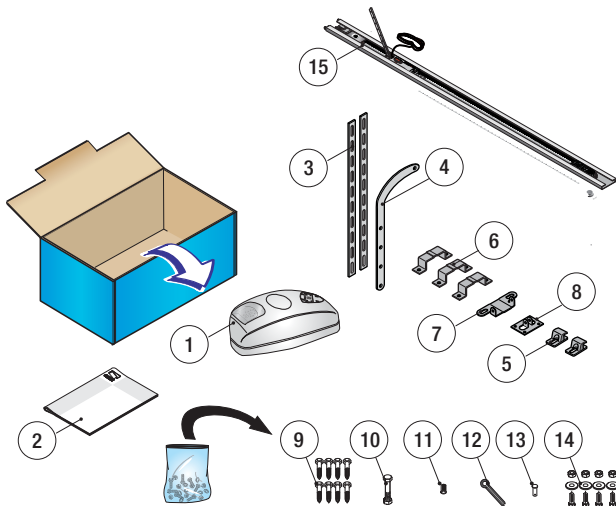

Description of the components

Operator

1. Cover
2. Gearmotor
3. Transformer
4. Control board
5. Power cord

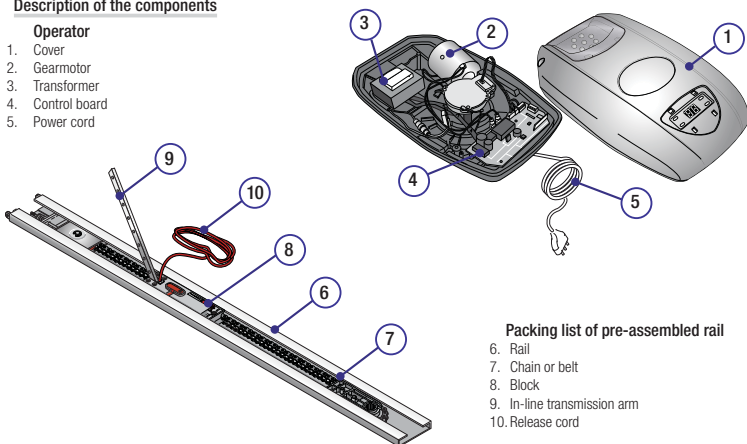

Packing list of pre-assembled rail

6. Rail
7. Chain or belt
8. Block
9. In-line transmission arm
10. Release cord

Slide rail

001V06001 Chain rail L = 3,02 m.
 - Canopy overhead doors up to 2.40 m in height;
 - Spring-balanced overhead doors up to 2.25 m in height;
 - Sectional doors* up to 2.20 m in height.

001V06002 Chain rail L = 3,52 m.
 - Spring-balanced overhead doors up to 2.75 m in height;
 - Sectional doors* up to 2.70 m in height.

001V06003 Chain rail L = 4,02 m.
 - Spring-balanced overhead doors up to 3.25 m in height;
 - Sectional doors* up to 3.20 m in height.

001V06005 Belt rail L = 3,02 m.
 - Canopy overhead doors up to 2.40 m in height;
 - Spring-balanced overhead doors up to 2.25 m in height;
 - Sectional doors* up to 2.20 m in height.

001V06006 Belt rail L = 3,52 m.
 - Spring-balanced overhead doors up to 2.75 m in height;
 - Sectional doors* up to 2.70 m in height.

001V06007 Belt rail L = 4,02 m.
 - Spring-balanced overhead doors up to 3.25 m in height;
 - Sectional doors* up to 3.20 m in height.

Optional Accessories

001V201 Transmission arm for canopy overhead doors

001V121 Cord release device to be applied to the handle

☞ For sectional doors, see the section EXAMPLES OF APPLICATION

Dimensions (mm)

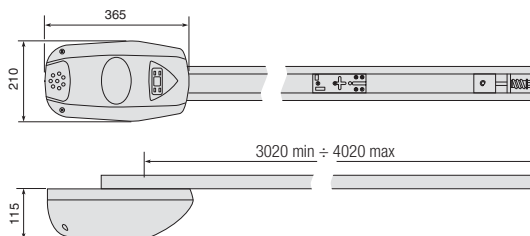

GENERAL INSTALLATION INSTRUCTIONS

△ Installation must be carried out by qualified and experienced personnel in compliance with applicable regulations.

Preliminary checks

△ Before starting installation:

- Provide a suitable single-pole disconnection device, with a maximum of 3 mm between the contacts, to disconnect the power supply;
- Prepare suitable piping and ducts for routing the electrical cables, ensuring protection against mechanical damage;
- ⊕ Make sure that any connections within the container (made to ensure the continuity of the protection circuit) are fitted with additional insulation compared to the other internal conductor parts;
- Check that the door is well-balanced. If halted at any intermediate point, it must maintain the position;
- If there is a pedestrian opening in the door, a safety switch must be added, connected to the STOP input, in order to prevent the operator from being operated when the pedestrian door is open.

Tools and materials

Make sure you have all the tools and materials you will need for the installation at hand to work in total safety and compliance with current standards and regulations. The figure shows some examples of installer's tools.

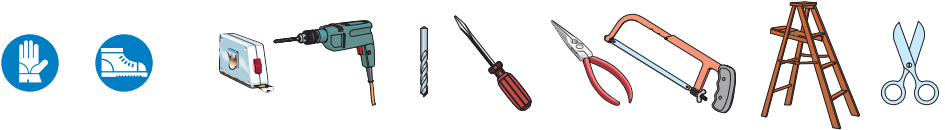

Types of cables and minimum thicknesses

Connection	Cable type	Cable length 1 < 10 m	Cable length 10 < 20 m	Cable length 20 < 30 m
Power supply	FROR CEI 20-22 IEC EN 50267-2-1	4G x 1.5 mm ²	4G x 2.5 mm ²	4G x 4 mm ²
Photocell transmitters		2 x 0.5 mm ²	2 x 0.5 mm ²	2 x 0.5 mm ²
Photocell receivers		4 x 0.5 mm ²	4 x 0.5 mm ²	4 x 0.5 mm ²
Control devices		2 x 0.5 mm ²	2 x 0.5 mm ²	2 x 0.5 mm ²
Antenna connection	RG58	max. 10 m		

☞ If the cables differ in length from what is shown in the table, the cable cross-section is determined according to the actual current draw of the devices connected and according to the provisions of the IEC EN 60204-1 standard.

For connections that require several, sequential loads, the sizes given on the table must be re-evaluated based on actual power draw and distances. When connecting products that are not specified in this manual, please refer to the documentation provided with said products.

Example of a system

1. Operator with receiver
2. Slide rail
3. Release device
4. Transmission arm
5. Key selector
6. Photocells
7. Pushbutton panel
8. Sensitive edge

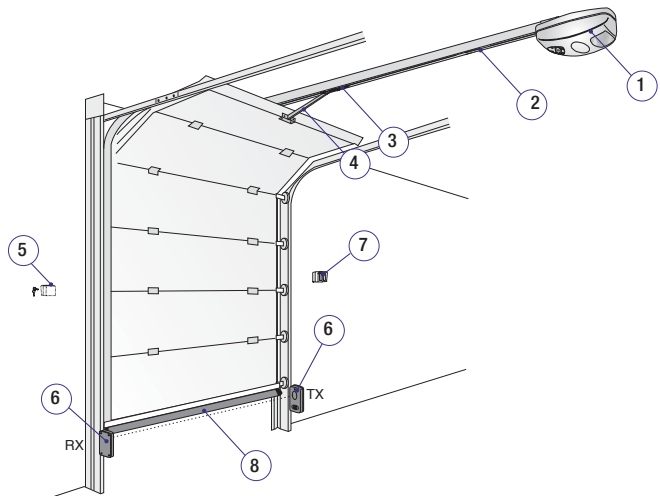

Examples of use

SECTIONAL DOOR

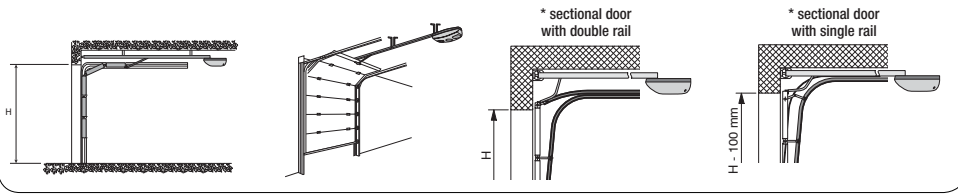

CANOPY OVERHEAD DOORS, with partially retracting movement.

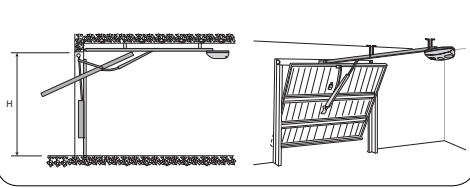

SPRING-BALANCED OVERHEAD DOOR, with fully retracting movement

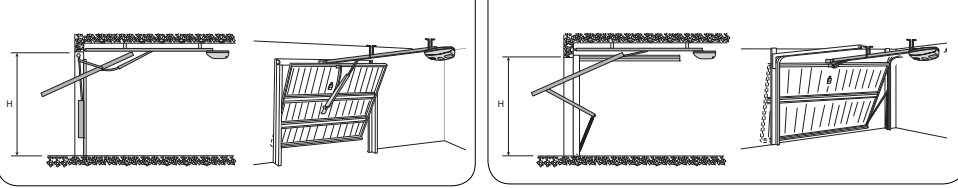

INSTALLATION

△ The following illustrations are only example as the space for securing the gearmotor and accessories varies in relation to dimensions. The installation technician is responsible for choosing the most suitable solution.

Assembling the transmission rail.

Secure the bracket to the transmission rail **a** using the screw and nut supplied **b**.

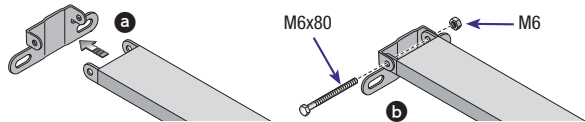

Position the slide rail as follows:

A for sectional doors above the post-spring bracket.

B for overhead doors between 10 and 20 mm from the highest point of the leaf sliding curve.

C for canopy overhead doors with partially retracting movement, use the V201 arm (see the accompanying technical documentation).

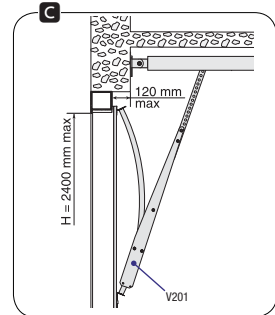
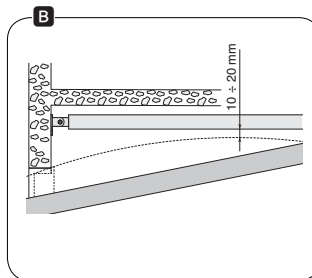
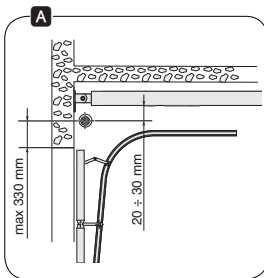

Securing the slide rail

D Secure the slide rail to the centre of the door compartment using suitable screws.

E Lift up the guide and place it horizontally to measure the distance from the ceiling and choose the type of fastening.

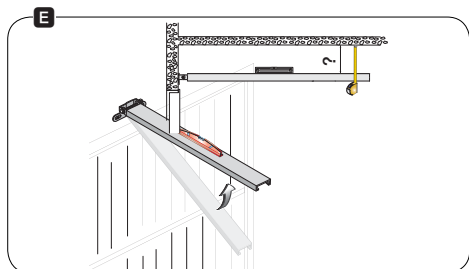
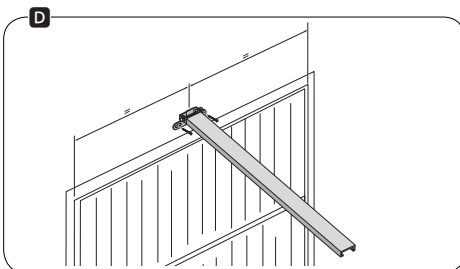

F Install the support brackets **a** and the U-bracket **b** on the rail.

Adapt the pierced plates, bending them, in order to compensate for the distance of the rail from the ceiling.

Secure the plates to the support brackets and the U-bracket using the screws and nuts supplied. Drill the ceiling at the point of the plate fixing holes. Secure the plates to the ceiling using suitable screws and anchors.

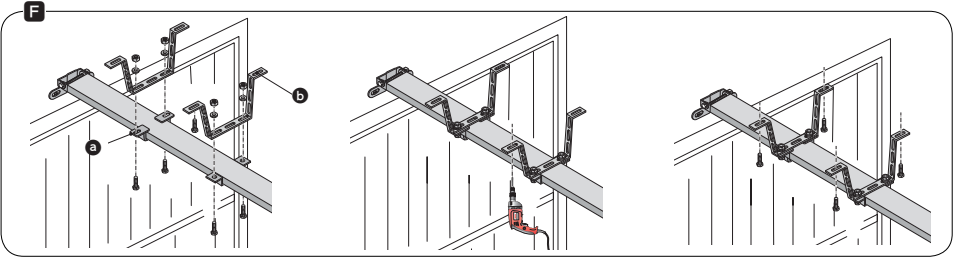

Securing the transmission arm to the door

Secure the door mounting bracket to the upper door crosspiece, perpendicularly to the rail. Use the screws supplied or other suitable screws.

G Secure the transmission arm **a** to the door mounting bracket using the insert and split pin supplied.

H If assembling the curved lever **b**, secure it to the transmission arm using the screws and nuts supplied.

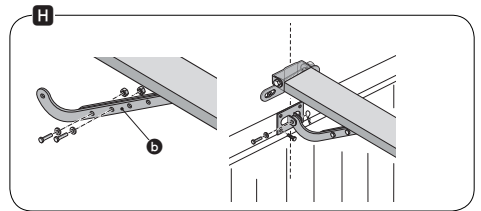
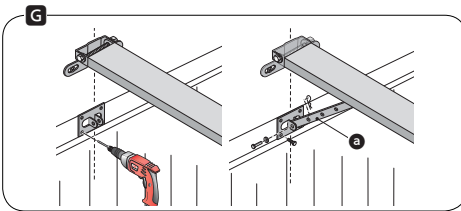

Securing the operator to the rail

Fit the adapter onto the motor shaft.

The operator can be fixed to the rail: in a standard position **I** or orthogonally **L**.

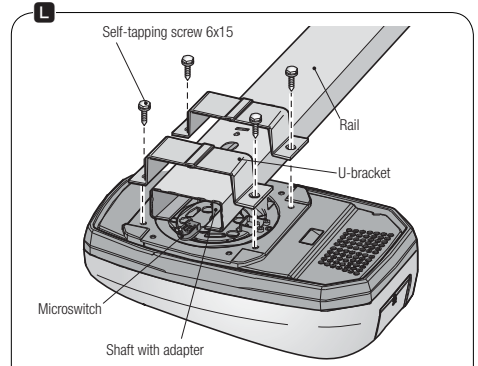
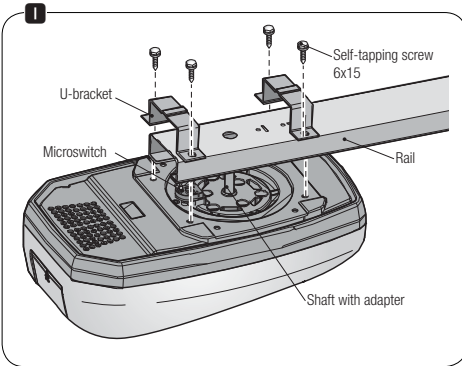

⚠ If mounting the operator in an orthogonal position, move the micro before installation (see the section: Moving the micro).

Moving the micro

Disconnect the microswitch cables and remove it.

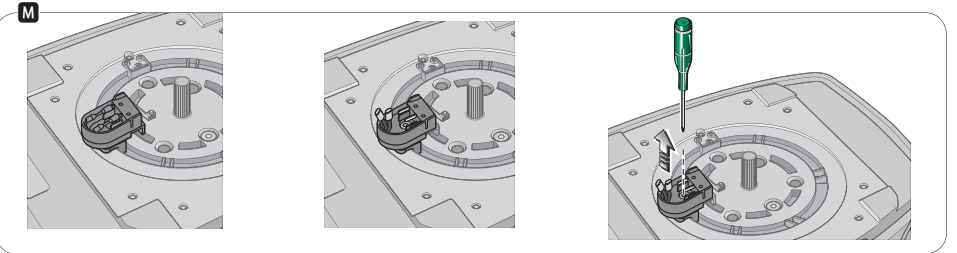

N Remove the cover of the operator and the cable clamp. Slide out the electrical cable and route into the through-hole.

Refit the cable clamp so that the hole is blocked.

Use the screwdriver to pierce the preformed hole to pass the microswitch electrical cables through and fit the cables into the micro.

Connect the connectors in the respective positions on the microswitch.

△ Reconnect the cables as in their original configuration (N.O.) - (C).

Secure the cover to the operator.



Operator latch

Latch

To release the operator, pull the cord Ⓢ downwards.

Locking

To lock the operator back into place, use the transmitter or a command button.

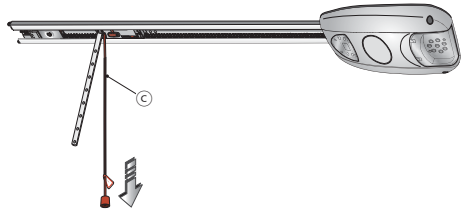

ELECTRICAL CONNECTIONS

△ Before intervening on the device, disconnect the line voltage.

Power supply (V - 50/60 Hz) 230 AC

Control board features:

- Motion control and obstacle detection
- Reopening during closing
- Adjustable automatic closing time
- Open-stop-close-stop from transmitter and/or button
- Courtesy light (stays on for a set time of 3 minutes and 30 seconds after an opening command).

FUSE TABLE

Line fuses (A)	5
----------------	---

LED

Courtesy Lights (W)	≤ 1
---------------------	-----

Description of the components

1. Line fuse
2. Gearmotor
3. Transformer
4. Cable inlet
5. AF board connector
6. Cable-antenna
7. Photozell connection terminal block
8. STOP button connection terminal block
9. Limit switch connection terminal block
10. Encoder connection terminal block
11. Display connection terminal block
12. Motor connections
13. Transformer connection
14. Courtesy light connection terminal block
15. Antenna connection terminal block
16. Flashing light connection terminal block

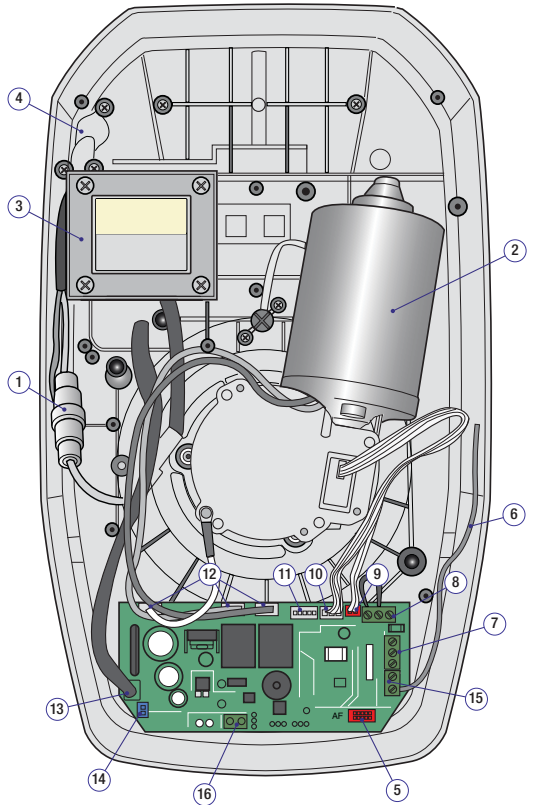

Motion control and obstacle detection

While OPENING: the door stops. To resume movement, press a button or use the transmitter.

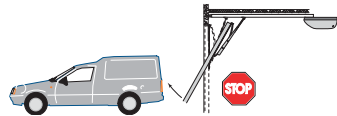

While CLOSING: it reverses the direction of movement until complete opening.

After three consecutive reversals, the door remains open, disabling automatic closing: in order to close it, use the transmitter or a button.

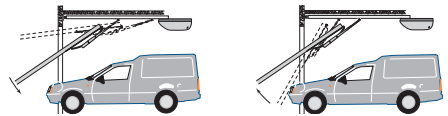

Power supply

△ The operator is supplied with an electric cable (L = 1.2 m) with Shuko socket already connected.

Warning devices

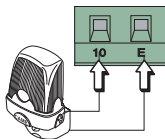
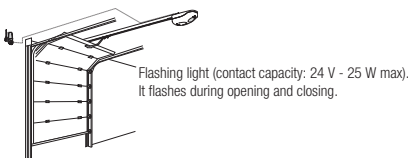

Control devices

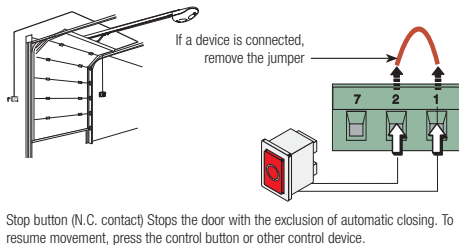
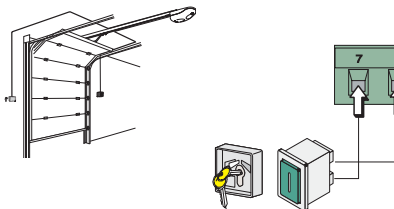

Safety devices

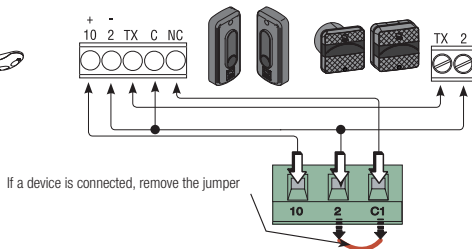
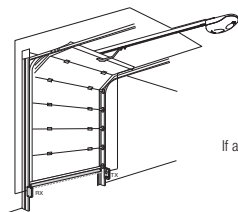

Reopening contact (N.C.) while closing.
Input for safety devices such as photocells, sensitive edges and other devices compliant with the EN 12978 standard.
While the operator is closing, the opening of the contact causes the reversal of the direction of movement until completely open.

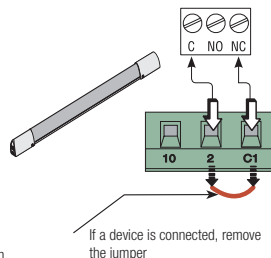

PROGRAMMING

Preparing for programming

Manually attach the door to the guide.
Power the operator. A sound means that the board is ready for programming.
Remove the transparent cover to gain access to the keys for programming.



△ Storage is always the last phase of programming (function 5), otherwise the settings are not saved.
In the event of setting errors, disconnect and reconnect the power supply and reprogram.

Description of the keys

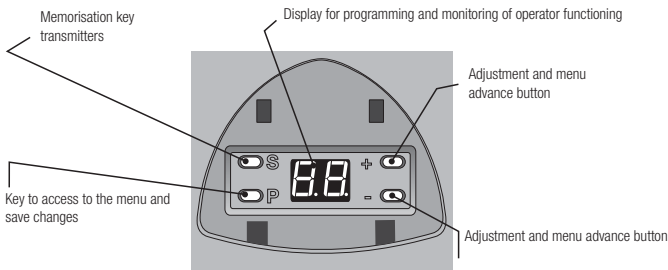

Key to symbols

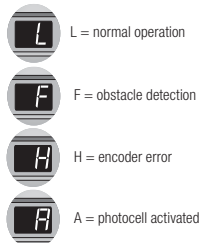

△ Some functions must be set so that the operator is able to work properly while others are optional

Mandatory functions

Determining the end-run points when opening

△ Follow the end-run point setting order indicated in this manual.

While operator is not moving

	Press P for about 5 seconds.
	The operator emits a single sound and 1 appears.
	Press P again, 1 flash.
	Press +
	Allow the door to reach the desired opening position.
	Press P to save the operation.

Determining the end run points while closing

	Press +, 2 appears.
	Press P, 2 flashes.
	Press -.
	Allow the door to reach the desired closing position.
	Press P to save the operation.

Checking run self-learning

	Press +, 3 appears.
	Press P, 3 flashes.
	The door reaches the closing end-run.
	Press P.
	The door reaches the closing limit switch.

Memorising the programming

△ IT IS MANDATORY to complete programming with this function to prevent loss of settings saved!



Press + to select 5.



Press P. The display segments turn in clockwise. Programming is successfully stored.

Adjusting sensitivity.

△ The door must be balanced correctly. If the sensitivity is too low, it may cause door malfunctioning.

By default, sensitivity is set to medium level. To increase or decrease the sensitivity:





	Press P for about 5 seconds, 4 appears.
	Press + and select 4.
	Press P, 4 appears.
	Press + or - to select an appropriate level of sensitivity.
<p>← Minimum Maximum Sensitivity Level →</p>	
	Press P to save the operation.

📖 Memorisation is always the last programming step (function 5), otherwise the settings are not saved.

Optional functions

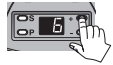
Setting the alarm

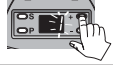







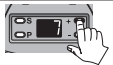

By default, the function is deactivated; when the alarm is active the operator will emit a beep if the door remains open for more than 10 minutes. To activate it:

	Press P for about 5 seconds, 1 appears.
	Press + and select 6
	Press P, 0 appears.
	Press + and select 1. The alarm is now active.
	Press P to save the setting.

☐ The last phase of programming is always storage (function 5), otherwise the settings are not saved.

Adjusting the automatic closing intervention time;

By default, the function is disabled. To activate it:

	Press P for about 5 seconds, 1 appears.
	Press + and select 7.
	Press P, 0 appears.
	Press + and select 1. Automatic closing is activated and the standby time is 30 seconds.
To change standby time before closing, press + or -.	
	60 seconds
	90 seconds
	120 seconds
	150 seconds
	180 seconds
	210 seconds
	240 seconds
	Press P to save the operation.

☐ The last phase of programming is always storage (function 5), otherwise the settings are not saved.

△ The operator emits a sound for 20 seconds before the door starts to close automatically. At the same time, the courtesy light flashes. When the door starts to close, the operator emits a sound and the courtesy light remains on steadily. With the door closed, the operator does not emit any sound and the courtesy light stays on for 3 minutes.



Manoeuvre counter

By default, the function is disabled.

When this function is activated, after 2,000 cycles, the operator beeps in indication of maintenance required.

△ To turn off the sound, disconnect and reconnect line voltage.

To activate:

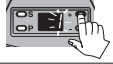
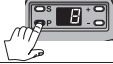
	Press P for about 5 seconds, 1 appears.
	Press + and select 8.
	Press P, 0 appears.
	Press +, 1 appears: the function is active.
	Press P to save the operation.



☐ The last phase of programming is always storage (function 5), otherwise the settings are not saved.

Automatic Closing Warning Function

By default, the function is active.

With function enabled, the operator emits a sound for 20 seconds before starting automatic closing.

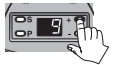
To disable, proceed as follows:

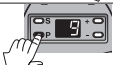
	Press P for about 5 seconds, 1 appears.
	Press + and select 9
	Press P, 1 appears.
	Press -, 0 appears: the function is disabled.
	Press P to save the setting.

☐ The last phase of programming is always storage (function 5), otherwise the settings are not saved.

Activating the radio control

Additional outdoor antenna

Disconnect the indoor antenna and connect the outdoor antenna to the appropriate terminals on the board.

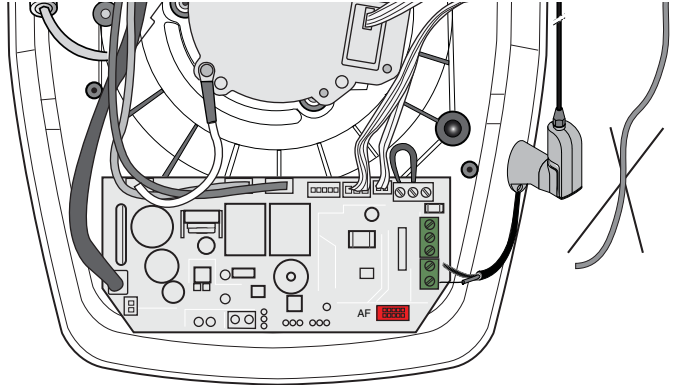

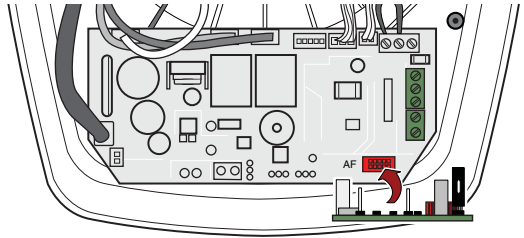

Radio frequency card

△ For proper operation, before inserting the AF plug-in card, INTERRUPT LINE VOLTAGE.



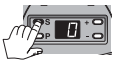

Saving the transmitters

You can store up to a maximum of 16* different codes/users. With the operator at a standstill:

	Press and hold down S until
	0 appears on the left side of the display. The 0 segments on the right side of the display rotate clockwise.
	Press the key to save twice in a row to memorise it.
△* When attempting to memorise the 17th code (transmitter), the courtesy light flashes slowly 5 times to show that the memory is full.	

Deleting the transmitters

	Press and hold down S until
	0 appears on the left side of the display. The 0 segments on the right side of the display rotate clockwise.
	When the 0 on the left disappears, release the S key; the transmitters have been deleted.

MAINTENANCE

⚠ Before any maintenance, disconnect line voltage to prevent any possible dangerous situations that can be caused by accidental movement of the operator. Lubricate the rotation points with grease whenever abnormal vibrations or squeaking occurs.

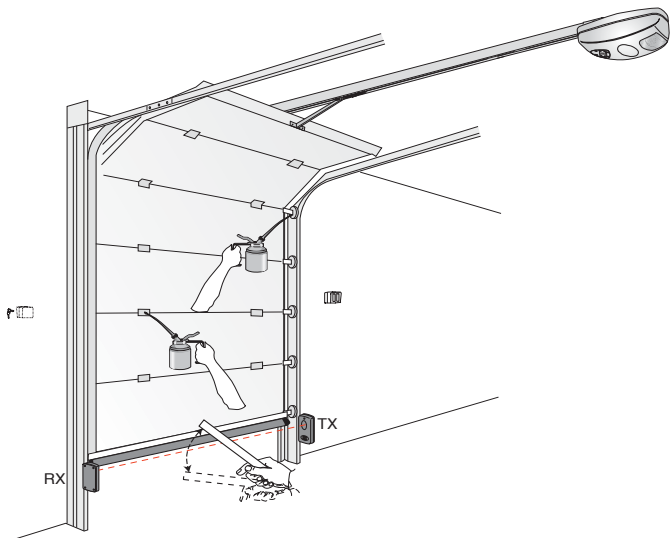

Periodic maintenance

Periodic maintenance log to be completed by the user (every six months)

Date	Notes	Signature

Extraordinary maintenance

△ The table below is used to note any extraordinary maintenance, repairs or improvements carried out by specialist companies.

△ Extraordinary maintenance must be carried out by specialist technicians.

Extraordinary maintenance log

Installation technician stamp	Operator name
	Date of intervention
	Technician signature
	Customer signature
Intervention carried out _____	

Installation technician stamp	Operator name
	Date of intervention
	Technician signature
	Customer signature
Intervention carried out _____ _____ _____	

TROUBLESHOOTING

Malfunctions	What to do
The operator does not open or close	1-3-25 1 - Check the power supply and line fuses 3 - The NO command contact (7-2) is open
The operator opens but does not close	4-10-23 4 - The NC safety contact (2-C1) is open
The operator closes but does not open	23 5 - The NC safety contacts are open
The operator does not close automatically	9-10 9 - Check that a time is set on menu 7
The transmitter does not work	14 10 - Check the correct direction of travel
The operator is too powerful	16 14 - Re-memorise the radio code
The operator is not powerful enough	16-17-23-24 16 - Adjust the sensitivity on menu 4
The operator reverses direction	16-17-23-24 17 - Eliminate mechanical friction
Only one transmitter is operational	18 18 - Enter (or copy) the same code for all the transmitters
The photocells do not respond	4-19 19 - Check photocell operation
The voltage present indicator LED is off	1-3 23 - Check door balancing
The operator reverses direction at the end run	10-17-23 24 - Check belt/chain tension
The operator starts slowly	17-23-24 25 - Encoder malfunctioning; disconnect and reconnect power to the board

DISMANTLING AND DISPOSAL

 CAME CANCELLI AUTOMATICI S.p.A. implements an EN ISO 14001-certified and compliant Environmental Management System at its plants, to ensure environmental protection. Please continue our efforts to protect the environment, something that CAME considers to be one of the foundations in developing its business and market strategies, simply by observing brief recommendations as regards disposal:

DISPOSAL OF PACKAGING

Packaging components (cardboard, plastic, etc.) can be disposed of together with normal household waste without any difficulty, by simply separating the different types of waste and recycling them. Before proceeding, it is always advisable to check specific regulations in force in the place of installation.
DISPOSE OF PROPERLY!

DISPOSAL OF THE PRODUCT

Our products are made with different materials. Most of them (aluminium, plastic, iron, electrical cables) can be disposed of together with normal household waste. They can be recycled if collected, sorted and sent to authorised centres. Other components (control boards, transmitter batteries, etc.), on the other hand, may contain pollutants. They should therefore be removed and handed over to companies authorised to recover and recycle them. Before proceeding, it is always advisable to check specific regulations in force in the place of disposal.
DISPOSE OF PROPERLY!

DECLARATION OF CONFORMITY

Declaration  - CAME CANCELLI AUTOMATICI S.p.A. declares that this device complies with the essential requirements and other relevant provisions established in Directives 2006/95/EC and 1999/5/EC.

Reference code for requesting a true copy: DDC L V001

IT • Per ogni ulteriore informazione su azienda, prodotti e assistenza nella vostra lingua:

EN • For any further information on company, products and assistance in your language:

FR • Pour toute autre information sur la société, les produits et l'assistance dans votre langue :

DE • Weitere Infos über Unternehmen, Produkte und Kundendienst bei:

ES • Por cualquier información sobre la empresa, los productos y asistencia en su idioma:

NL • Voor meer informatie over het bedrijf, de producten en hulp in uw eigen taal:

PT • Para toda e qualquer informação acerca da empresa, de produtos e assistência técnica, em sua língua:

PL • Wszystkie inne informacje dotyczące firmy, produktów oraz usług i pomocy technicznej w Waszym języku znajdują się na stronie:

RU • Для получения дополнительной информации о компании, продукции и сервисной поддержке на вашем языке:

HU • A vállalatra, termékeire és a műszaki szervizre vonatkozó minden további információért az Ön nyelvén:

HR • Za sve dodatne informacije o poduzeću, proizvodima i tehničkoj podršci:

UK • Для отримання будь-якої іншої інформації про компанію, продукцію та технічну підтримку:



English - Manual code: **119E108EN** ver. **5** 09/2013 © CAME cancelli automatici S.p.a.
The data and information provided in this manual are subject to change at any time without prior notice by CAME Cancelli Automatici S.p.a.



CAMEGROUP

CAME Cancelli Automatici S.p.a.

Via Martiri Della Libertà, 15

31030 **Dosson Di Casier** (Tv)

☎ (+39) 0422 4940

☎ (+39) 0422 4941

Assistenza Tecnica/Numero Verde 800 295830